

LATAM



ILUMINACIÓN LED PROFESIONAL

GUÍA DE PRODUCTO 2023

Televes[®]



CiES

**LUMINARIA ECOLÓGICA
DE POLÍMERO TÉCNICO
INVULNERABLE EN CUALQUIER
AMBIENTE**



Comportamiento excelente, por dentro y por fuera:

- ✓ Eficiente y práctica en condiciones extremas
- ✓ Respetuosa con el medio ambiente y con la calidad del cielo nocturno

100% made in Televes

lighting.televes.com



Televes Corporation®



www.televescorporation.com | www.televes.com

Televes

CONSIDERACIONES:

Televes manifiesta que este folleto es meramente informativo y declina cualquier responsabilidad que pudiese derivarse de posibles errores u omisiones en el contenido del mismo.

Las fotografías de los productos no son contractuales y Televes podría no suministrarlos o estos podrían sufrir variaciones, modificaciones y/o alteraciones en cualquier momento y sin previo aviso.

Las ilustraciones de distribución lumínica son proyecciones aproximadas de referencia.

Nuestras Declaraciones de Conformidad (DoC), Prestaciones (DoP), etc, están disponibles en: www.doc.televes.com

- ★ Novedad
- PC Precio por Confirmar
- 🔍 Color identificativo en producto
- 💡 Temperatura de color

ALUMBRADO EXTERIOR INTERURBANO	15
CIES	15
Serie E	15
Serie E-4.....	17
Serie N.....	18
Serie Z.....	19
ATMOSLED	20
Serie E	20
Serie E-4.....	24
Serie N.....	27
Serie Z.....	29
ACCESORIOS	32
ALUMBRADO EXTERIOR URBANO Y RESIDENCIAL	33
URBAN ALAMEDA	33
Serie E	33
Serie E-4.....	33
Serie Z.....	34
URBAN MAIA	35
Serie E	35
Serie E-4.....	37
Serie Z.....	38
FAROLES ORNAMENTALES	40
Villa	40
Fernandina.....	43
ACCESORIOS	46
PROYECTORES	47
ZONAS DEPORTIVAS Y GRANDES ÁREAS	47
Proyector Flex.....	47
Proyector Maxi.....	49
ILUMINACIÓN ARQUITECTÓNICA Y ARTÍSTICA	50
Proyector Estándar.....	50
ACCESORIOS	51
BALIZAS	52
AROUSA	52
Modelo alto (L).....	52
Modelo bajo (S).....	52
ALUMBRADO INTERIOR INDUSTRIAL	53
INNERLED	53
CAMPANA ZAR (UFO)	54
ACCESORIOS	54
RENOVACIÓN DEL ALUMBRADO (RETROFIT)	55
COMPONENTE RETROFIT	55
ACCESORIOS	58
TELEGESTIÓN	59
CONTROL DE CUADRO ELÉCTRICO	59
CONTROL PUNTO A PUNTO	59
Nodos Tipo Nema.....	59
Nodos Tipo Box.....	59
PLATAFORMA AURANT IOT	59

ILUMINACIÓN LED PROFESIONAL

GAMAS DE ILUMINACIÓN LED

CIES

LUMINARIA ECOLÓGICA DE POLÍMERO TÉCNICO INVULNERABLE EN CUALQUIER AMBIENTE

CIES es la primera serie de luminarias fabricada en polímeros técnicos especialmente formulados por Televés, aunando diseño, ingeniería mecánica y de materiales y la última tecnología electrónica para satisfacer a los clientes más exigentes.

Gracias a esta serie se aporta una solución novedosa en el mercado de la iluminación, ideal para los ambientes más agresivos y con la que se optimiza a la vez la operación, instalación y el mantenimiento.



Iluminación vial e interurbana



Iluminación zonas marítimas



Telegestión:
Serie N | Serie Z

ATMOSLED

ALUMBRADO VIAL INTERURBANO Y PARA ÁREAS EXTERIORES DIVERSAS

Luminaria vial altamente versátil adaptable a cualquier entorno exterior, construida en aluminio extruido anodizado especialmente diseñada para una perfecta gestión térmica, optimización de la vida útil de servicio y resistencia a ambientes agresivos.

Pensada para incrementar el ahorro energético y reducir los costes de mantenimiento gracias a su elevada eficiencia y durabilidad.



Iluminación vial e interurbana



Telegestión:
Serie N | Serie Z

GAMAS DE ILUMINACIÓN LED

URBAN ALAMEDA | MAIA

LUMINARIAS CON UN ESTILO FRESCO PARA REALZAR LA ILUMINACIÓN EN EL CORAZÓN DE LAS CIUDADES

Luminaria urbana decorativa fabricada en fundición inyectada de aluminio. La serie Urban presenta un diseño compacto y suaves líneas geométricas, que se integran armoniosamente con el conjunto, siendo perfecta para entornos urbanos y residenciales.

Destaca por su fácil montaje y mantenimiento sin necesidad de herramientas. Además, su protector de vidrio templado de alta calidad favorece el confort visual y reduce el deslumbramiento.



Iluminación urbana y residencial



Telegestión:
Serie Z

FAROLAS VILLA | FERNANDINA

LUMINARIAS CLÁSICAS DE GRAN VALOR HISTÓRICO Y DECORATIVO CON LA TECNOLOGÍA LED MÁS MODERNA

Luminarias de gran valor decorativo y artístico, que combinan una línea clásica y tradicional con la tecnología LED más avanzada y eficiente.

Su diseño ofrece la oportunidad de preservar el patrimonio histórico, a la vez que se obtiene una mejor iluminación, responsable y adaptada al entorno. De fácil montaje y mantenimiento, es ideal para espacios históricos y urbanos así como calles residenciales, plazas o parques.



Alumbrado ornamental

ILUMINACIÓN LED PROFESIONAL

GAMAS DE ILUMINACIÓN LED

PROYECTORES FLEX

ILUMINACIÓN MODULAR DE ALTA POTENCIA PARA INSTALACIONES DEPORTIVAS PROFESIONALES Y GRANDES ÁREAS



Los proyectores Flex combinan un excelente rendimiento y una elevada potencia en un práctico formato modular, hasta 4 módulos por soporte, optimizando los recursos. Gracias a su elevada eficiencia, durabilidad y facilidad de mantenimiento, se obtiene una excelente rentabilidad.

Su diseño escalable, de 1 a 4 módulos sobre un único soporte y las diferentes configuraciones por módulo (potencia, óptica y n.º de LEDs), ofrecen una gama de 250 a 1200 W. Un amplio abanico de posibilidades que convierte a los proyectores Flex en una elección acertada para cualquier espacio.



Instalaciones especiales



Iluminación de zonas deportivas

PROYECTORES MAXI

ALUMBRADO PARA ZONAS DEPORTIVAS Y GRANDES ÁREAS



Los proyectores son luminarias de alto rendimiento y gran potencia. Tienen la capacidad de orientar el flujo lumínico en un ángulo determinado con gran precisión, exponiendo únicamente el área de interés a la iluminación proporcionada.

Los proyectores Maxi están diseñados especialmente para iluminar grandes superficies deportivas, cumpliendo a la perfección con las exigencias visuales necesarias para la práctica deportiva, incluso para las competiciones de más alto nivel.



Iluminación de zonas deportivas

GAMAS DE ILUMINACIÓN LED

PROYECTORES ESTÁNDAR

ALUMBRADO QUE POTENCIA LA BELLEZA DE LAS CIUDADES A TRAVÉS DE LA LUZ

Los proyectores Estándar son la solución idónea para la iluminación ornamental, artística o monumental, donde la luz adquiere un valor sumamente estético. Su objetivo es destacar la belleza de los objetos para atraer la atención del público, tratando la iluminación como un arte, a través del correcto manejo de las luces, sombras, contrastes y colores.

El proyector Estándar combina su tamaño reducido con grandes prestaciones lumínicas, incorporándose de manera sutil en los diferentes paisajes enfatizando los objetos de interés a través de un haz de luz intenso de gran calidad y elevada eficiencia.



Alumbrado ornamental

AROUSA

LUMINARIAS INOXIDABLES Y ANTIVANDÁLICAS PARA ZONAS PEATONALES Y JARDINES

La baliza Arousa destaca por su alta resistencia y capacidad para permanecer inalterable en cualquier entorno, gracias a su alta protección frente a impactos y su recubrimiento de barniz incoloro anti-grafitis. Además, su alta estanqueidad y su cuerpo de acero inoxidable, también evitan la entrada de agua y la oxidación. Arousa es una baliza de alta durabilidad, customizable en diferentes aspectos, como prestaciones, color y acabado.

Disponible en dos alturas.



Iluminación zonas marítimas



Alumbrado de señalización

ILUMINACIÓN LED PROFESIONAL

GAMAS DE ILUMINACIÓN LED

INNERLED

LUMINARIA LINEAL PARA ESTANCIAS RECTANGULARES EN ENTORNOS INDUSTRIALES Y PROFESIONALES



Luminaria LED de alto rendimiento y calidad para interior. Fabricada en aluminio extruido y anodizado que aumenta su dureza, presenta una gran resistencia frente a impactos y a la corrosión, garantizando una elevada durabilidad.

La estructura de InnerLED favorece el control térmico del driver y del módulo LED, siendo válida para usos intensivos sin elevar su temperatura.

Gracias a su elevada eficiencia y durabilidad, InnerLED resulta una excelente solución para reducir el consumo energético y los costes de mantenimiento, a la vez que ofrece una iluminación impecable creando espacios más agradables y con un mayor confort visual.



Iluminación industrial



Iluminación de zonas deportivas

CAMPANA ZAR

CAMPANA TIPO UFO PARA ESPACIOS DIÁFANOS EN ENTORNOS INDUSTRIALES Y PROFESIONALES

Luminaria LED para interior construida en inyección de aluminio especialmente diseñada para una perfecta gestión térmica, optimización de la vida útil de servicio y elevada eficiencia.

En entornos industriales y profesionales es importante contar con buenos niveles de iluminación que contribuyan a la seguridad laboral, al confort visual y a la productividad. La campana ZAR es una luminaria con gran capacidad para iluminar espacios amplios que requieren una correcta iluminación, alcanzando los niveles de calidad lumínica más exigentes (CRI > 80).



Iluminación industrial

GAMAS DE ILUMINACIÓN LED

RETROFIT

RENOVACIÓN A TECNOLOGÍA LED CONSERVANDO LA ESTRUCTURA ORIGINAL DE LA LUMINARIA



El Retrofit es la sustitución directa de tecnologías de iluminación antiguas por otras más modernas y eficientes, usando las instalaciones previas. Es la solución perfecta de iluminación para un consumo sostenible, con gran eficiencia y altas prestaciones.

Retrofit es una apuesta segura a favor de la ecología, ya que se prioriza la minimización de los residuos generados al aprovechar las estructuras existentes. También destaca por el bajo consumo de la tecnología LED y su gran durabilidad, ofreciendo una iluminación responsable al controlar la luz emitida al hemisferio superior de la luminaria.



Renovación del alumbrado



Alumbrado ornamental



Iluminación vial e interurbana:

Vías de tráfico rodado, carreteras, vías de alta velocidad, autopistas, rotondas, peajes.

Son más específicas para zonas cuyo uso exclusivo es de vehículos.



Iluminación zonas marítimas:

Puertos, pantalanes, calles, paseos marítimos.

Son perfectas para espacios frecuentados por peatones y por vehículos en ambientes agresivos como entornos marítimos.



Iluminación urbana y residencial:

Áreas urbanas, calles, paseos, parques, zonas residenciales, urbanizaciones.

Son perfectas para zonas frecuentadas por peatones, pero también por vehículos.



Alumbrado ornamental:

Zonas monumentales, áreas históricas, patrimonio protegido, puentes, iglesias, murallas.

Uso principalmente ornamental. Ofrecen iluminación ambiental integrada con la decoración de la zona y también se utilizan para resaltar objetos a través de luces y sombras.



Iluminación de zonas deportivas:

Áreas deportivas como polideportivos, campos de fútbol, canchas de baloncesto, pistas de pádel y de tenis, piscinas...

Diseñadas para zonas donde el control y direccionamiento de la luz de forma precisa es crucial.



Alumbrado de señalización:

Paseos, caminos, parques, jardines, hoteles, terrazas.

Balizas para orientar y guiar a los viandantes, perfectas para zonas que demandan una iluminación ambiental para mantener la visibilidad.



Iluminación industrial:

Sector industrial, plantas productivas, almacenes logísticos.

Para zonas que requieren condiciones estrictas de seguridad, robustez y duración de las luminarias.



Instalaciones especiales:

Puertos deportivos, muelles de carga, aeropuertos.

Iluminación de alta fiabilidad para áreas donde es crítico mantener una iluminación adecuada, asegurando la visibilidad y la seguridad de los usuarios.



Renovación del alumbrado:

Todo tipo de alumbrado público.

Se utiliza especialmente en zonas donde es importante mantener las luminarias por su valor histórico.



Telegestión:

Alumbrado público para integración en el ámbito de una Smart City.

Dispositivos y complementos que otorgan a las luminarias la capacidad de conexión a un sistema de telegestión y comunicación con estructuras de IoT.

ÓPTICAS

Distribución lumínica LENTES



Tipo
S20

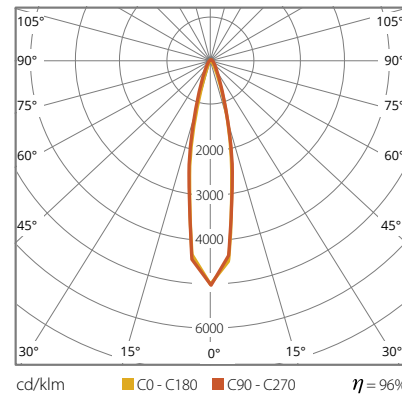

Tipo
S30

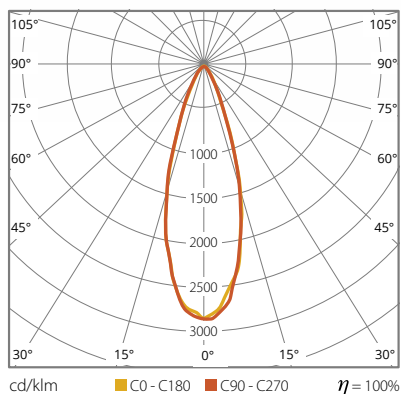

Tipo
S40

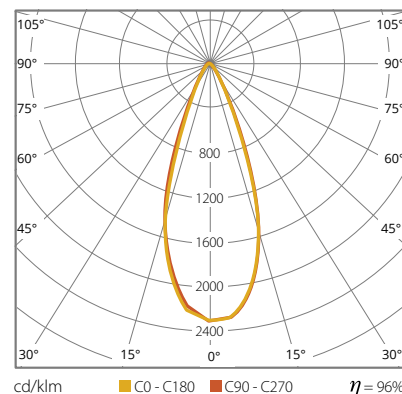

Tipo
S60

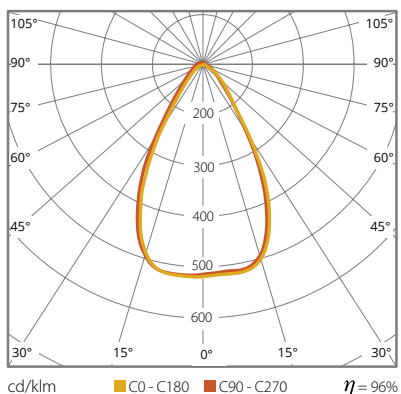

Tipo
S90

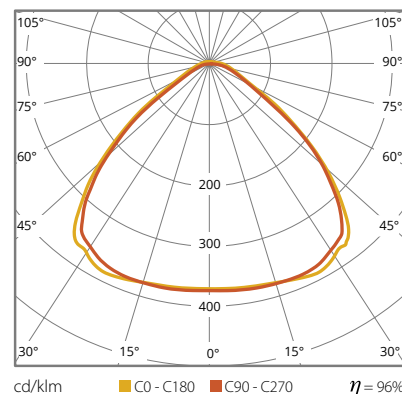

Tipo
S120

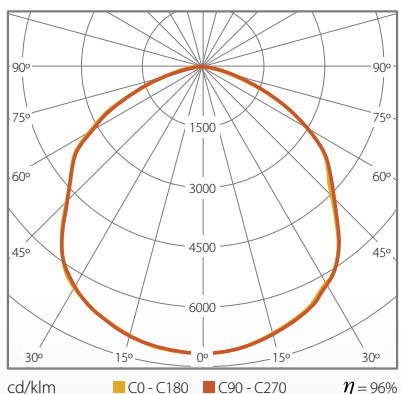

Tipo
SP

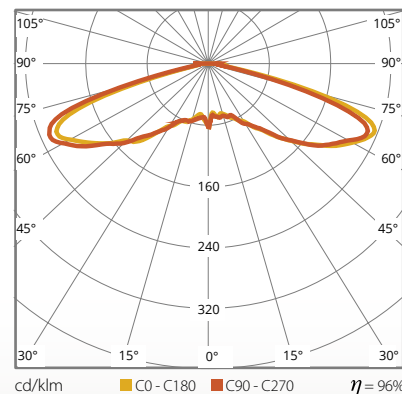

ÓPTICAS

Tipo
P

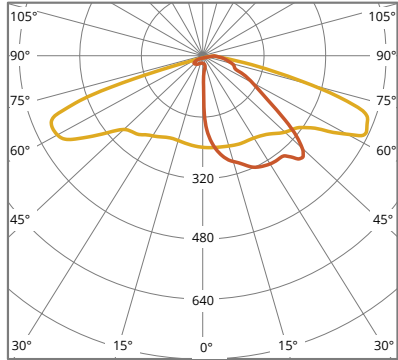

cd/klm ■ C0 - C180 ■ C90 - C270 $\eta = 94\%$

Tipo
SCL

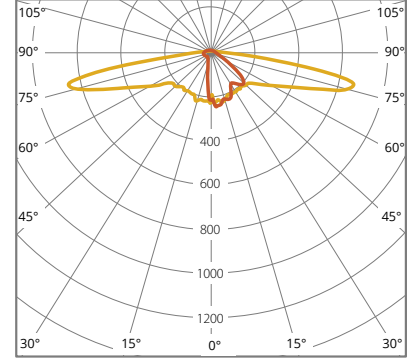

cd/klm ■ C0 - C180 ■ C90 - C270 $\eta = 96\%$

Tipo
T2

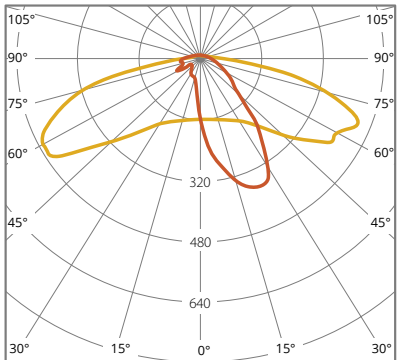

cd/klm ■ C0 - C180 ■ C90 - C270 $\eta = 90\%$

Tipo
T3

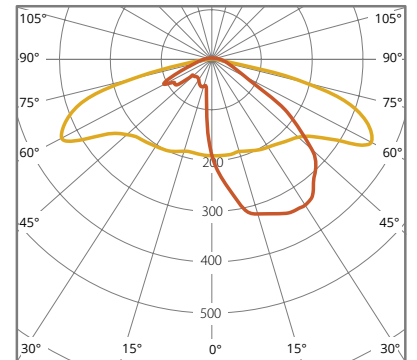

cd/klm ■ C0 - C180 ■ C90 - C270 $\eta = 92\%$

Tipo
K

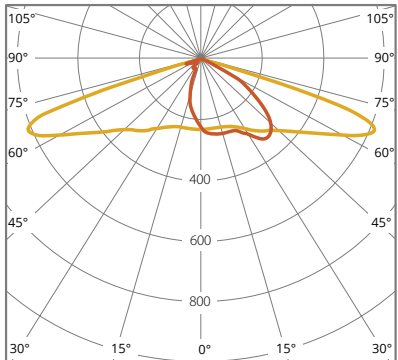

cd/klm ■ C0 - C180 ■ C90 - C270 $\eta = 100\%$

Tipo
ME

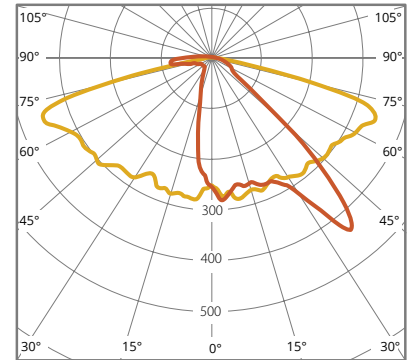

cd/klm ■ C0 - C180 ■ C90 - C270 $\eta = 88\%$

Tipo
APZ

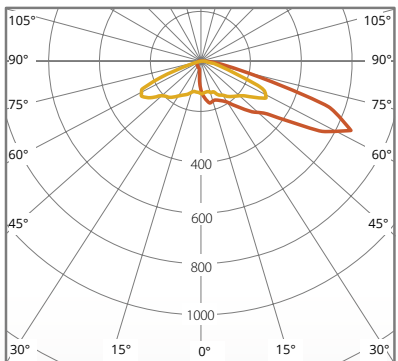

cd/klm ■ C0 - C180 ■ C90 - C270 $\eta = 96\%$

Tipo
D90

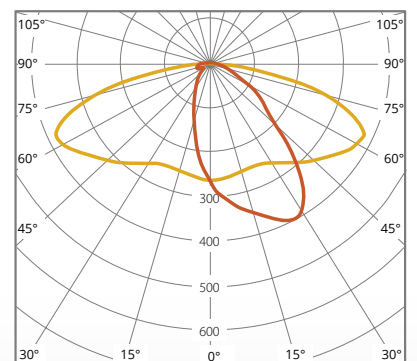

cd/klm ■ C0 - C180 ■ C90 - C270 $\eta = 100\%$

ILUMINACIÓN LED PROFESIONAL

NODOS TELEGESTIÓN

Por su extensión, por su complejidad, y por los innegables beneficios que aporta para los ciudadanos, la conectividad punto a punto de los sistemas de iluminación LED se ha convertido en imprescindible en la gestión de una *Smart City*.

Las principales ventajas que aportan son:

- Incremento en la **eficiencia del sistema**, en tanto que la sensorización nos permite modificar la intensidad en función de las necesidades de la población en cada localización, de una forma mucho más flexible que programaciones horarias prefijadas.
- Capacidad de **control**, y por lo tanto de adaptación a los cambios en la iluminación instantáneos que pueda requerir la ciudad (incremento en los niveles por causas no programadas como eventos, fiestas patronales, o situaciones de emergencia).
- Capacidad de **monitorización de la red**, y por lo tanto detección temprana de incidencias, lo que abre la posibilidad a la planificación y por lo tanto a la eficiencia en la operación y el mantenimiento de la red.

Hemos añadido, en varias gamas de luminarias, las **Series N y Z**. Estas nuevas series cuentan con conectores de regulación, que permiten establecer una conexión Plug&Play con nodos de telegestión y proporcionar, por tanto, la capacidad de conexión a infraestructuras IoT.

■ **Serie N:** Estándar ANSI C163.41 NEMA

■ **Serie Z:** Estándar Zhaga book 18

Esta **interfaz abierta** permite que las luminarias de las series N y Z se puedan conectar a cualquier sistema de telegestión, independientemente de la tecnología utilizada para cada proyecto de *Smart City*, tanto en función de su orografía, como la existencia o no de otras redes IoT en la ciudad, o los casos de uso y control a implementar, pudiendo tratarse de conexión a través de la línea eléctrica (PLC, PLC de banda ancha), o de redes inalámbricas (3G, NB-IoT, LoraWan, Lora-Mesh, Zigbee,...).



PLC: Tecnologías de las líneas de transmisión de energía eléctrica convencionales para transmitir señales con propósitos de comunicación. PLC aprovecha la red eléctrica para convertirla en una línea digital de alta velocidad de transmisión de datos.

3G: Tercera generación de transmisión de voz y datos a través de telefonía móvil mediante UMTS (*Universal Mobile Telecommunications System*).

NB-IoT: (NarrowBand IoT). Primera tecnología de comunicaciones estándar y abierta pensada para conectar a Internet los pequeños objetos de nuestra vida diaria. Esta tecnología utiliza la red móvil (3G/4G/5G) para conectar de forma fácil, segura y fiable cualquier objeto. Gracias a que usa la red de comunicaciones de un operador móvil, proporciona mejores niveles de cobertura, tanto en interior como en exterior.

LoRa: Tecnología inalámbrica que emplea un tipo de modulación en radiofrecuencia.

DIMMING O CONTROL DE ILUMINACIÓN

El *dimming* o control de iluminación permite la regulación de cada punto de luz hasta el nivel que la lámpara admita, en este caso, 10 niveles de iluminación.

Esta **SOLUCIÓN AUTÓNOMA** consiste en un controlador situado en cada luminaria, con un horario pre-programado para cada farola, que le indica a qué nivel de iluminación debe funcionar en cada hora de la noche.

Este sistema reduce los costes de mantenimiento alargando la vida de los componentes y nos ayudan a aumentar todavía más el ahorro energético asociado a la iluminación LED.

Por defecto, el plan de iluminación que ofrece el *dimming* consiste en dos franjas horarias de máxima iluminación, con un periodo en el medio de menor iluminación. El sistema se ajusta al horario de encendido y apagado marcado por el cuadro de mando, de forma que se emite una iluminación máxima (100%) en el horario de más movimiento (a primera hora de la mañana y última de la tarde), y se reduce gradualmente en las horas más tranquilas (madrugada), bajando hasta un 70% de iluminación. Además, el dimming se reajusta para adaptarse a cambios de horario según la época del año.

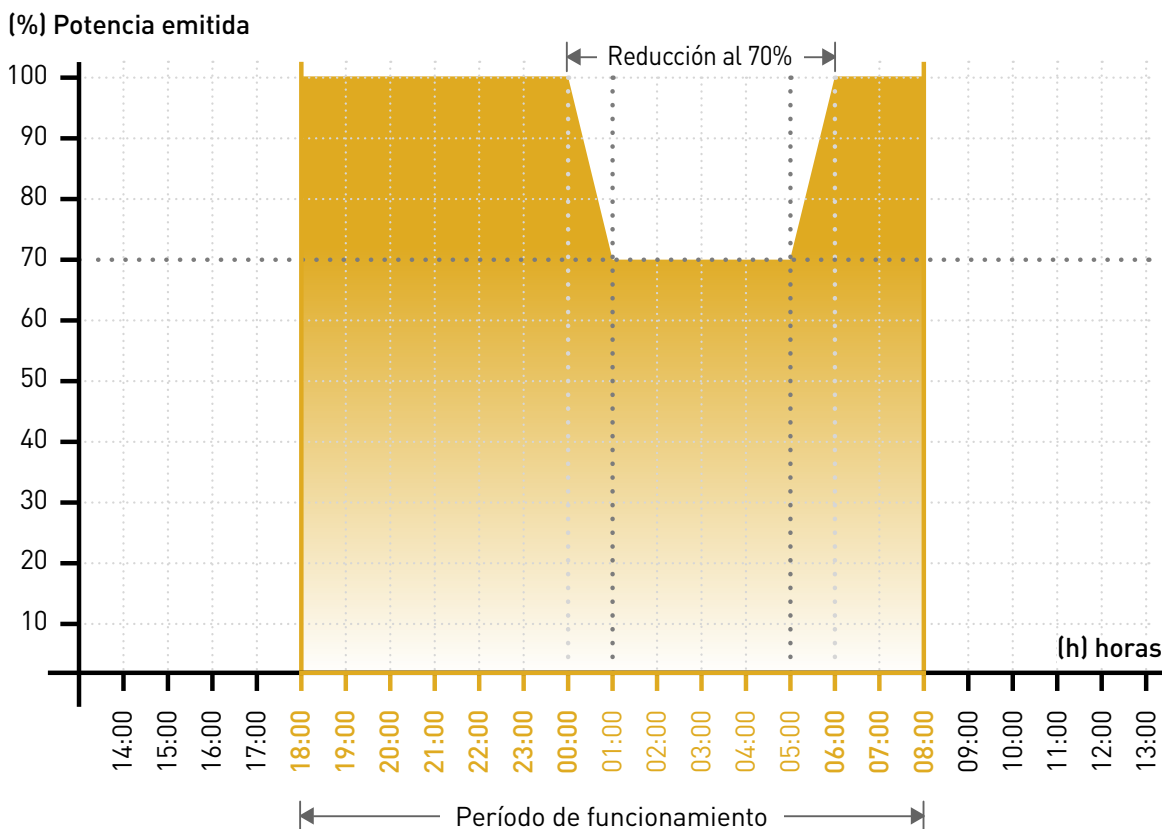

Dimming disponible sólo en referencias indicadas.

AMPLIA SELECCIÓN BAJO PEDIDO:

Desde Televés sabemos que cada situación requiere unas características determinadas de iluminación. En consecuencia, disponemos de gran variedad de opciones bajo demanda para satisfacer las necesidades de cada contexto:

- Ópticas
- Temperatura de color
- Color del chasis
- Dimming
- Telegestión
- CRI
- Temperatura de funcionamiento

Estamos a tu disposición para resolver cualquier duda o para proporcionarte todas las características técnicas y accesorios compatibles con nuestras gamas de iluminación profesional LED.

Contacta con nosotros a través de nuestra WEB:
<https://contents.televés.com/professional-led-lighting>

TIPO DE ÓPTICA:

S20	Simétrica 20	SCL	Asimétrica SCL
S30	Simétrica 30	T2	Asimétrica T2
S40	Simétrica 40	T3	Asimétrica T3
S60	Simétrica 60	K	Asimétrica K
S90	Simétrica 90	ME	Asimétrica ME
S120	Simétrica 120	APZ	Asimétrica PZ
SP	Pública simétrica	D90	Asimétrica DWC90
P	Asimétrica Pública		

 **Temperatura de color**

2200 K	5000 K
3000 K	PC Ámbar
4000 K	

 **Color identificativo en producto**

Aluminio	Blanco/Gris
Negro	Inox mate

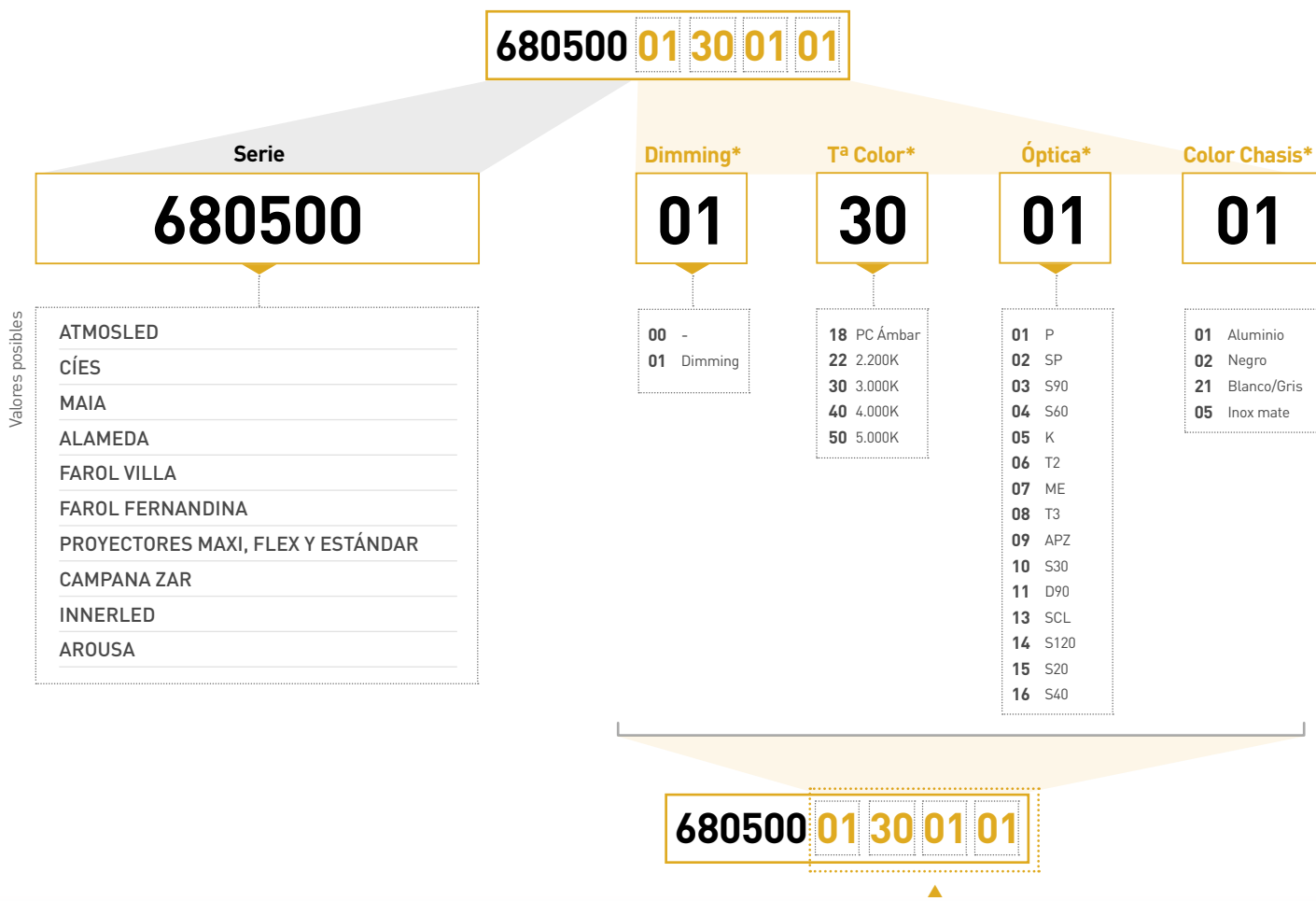

Los 8 últimos dígitos de cada referencia dependerán de la configuración solicitada para la luminaria.

Teniendo en cuenta el Dimming, la Temperatura de Color, la Óptica y el Chasis en el que vaya montado así como el color del mismo.

ALUMBRADO EXTERIOR INTERURBANO

CIES



REF. PEDIDO	REF. LÓGICA	Nº LEDs	💡	CONTROL	TIPO DE ÓPTICA	POTENCIA (W)	👤	EAN13
Serie E								
60060000180121	CI1218-PWG39	12	PC Ámbar	ON/OFF	P	39	Blanco/Gris	8424450258255
60060000180521	CI1218-KWG39	12	PC Ámbar	ON/OFF	K	39	Blanco/Gris	8424450258262
60060000180621	CI1218-T2WG39	12	PC Ámbar	ON/OFF	T2	39	Blanco/Gris	8424450258279
60060000180721	CI1218-MEWG39	12	PC Ámbar	ON/OFF	ME	39	Blanco/Gris	8424450258286
60060000180821	CI1218-T3WG39	12	PC Ámbar	ON/OFF	T3	39	Blanco/Gris	8424450258293
60060000180921	CI1218-APZWG39	12	PC Ámbar	ON/OFF	APZ	39	Blanco/Gris	8424450258309
60060000181321	CI1218-SCLWG39	12	PC Ámbar	ON/OFF	SCL	39	Blanco/Gris	8424450258316
60060000220121	CI1222-PWG39	12	2200K	ON/OFF	P	39	Blanco/Gris	8424450243046
60060000220521	CI1222-KWG39	12	2200K	ON/OFF	K	39	Blanco/Gris	8424450243053
60060000220621	CI1222-T2WG39	12	2200K	ON/OFF	T2	39	Blanco/Gris	8424450243060
60060000220721	CI1222-MEWG39	12	2200K	ON/OFF	ME	39	Blanco/Gris	8424450243077
60060000220821	CI1222-T3WG39	12	2200K	ON/OFF	T3	39	Blanco/Gris	8424450243084
60060000220921	CI1222-APZWG39	12	2200K	ON/OFF	APZ	39	Blanco/Gris	8424450243091
60060000221321	CI1222-SCLWG39	12	2200K	ON/OFF	SCL	39	Blanco/Gris	8424450243114
60060000300121	CI1230-PWG39	12	3000K	ON/OFF	P	39	Blanco/Gris	8424450240212
60060000300521	CI1230-KWG39	12	3000K	ON/OFF	K	39	Blanco/Gris	8424450243206
60060000300621	CI1230-T2WG39	12	3000K	ON/OFF	T2	39	Blanco/Gris	8424450243213
60060000300721	CI1230-T2WG39	12	3000K	ON/OFF	ME	39	Blanco/Gris	8424450243220
60060000300821	CI1230-T3WG39	12	3000K	ON/OFF	T3	39	Blanco/Gris	8424450243237
60060000300921	CI1230-APZWG39	12	3000K	ON/OFF	APZ	39	Blanco/Gris	8424450243244
60060000301321	CI1230-SCLWG39	12	3000K	ON/OFF	SCL	39	Blanco/Gris	8424450243268
60060000400121	CI1240-PWG39	12	4000K	ON/OFF	P	39	Blanco/Gris	8424450243275
60060000400521	CI1240-KWG39	12	4000K	ON/OFF	K	39	Blanco/Gris	8424450238790
60060000400621	CI1240-T2WG39	12	4000K	ON/OFF	T2	39	Blanco/Gris	8424450243282
60060000400721	CI1240-MEWG39	12	4000K	ON/OFF	ME	39	Blanco/Gris	8424450243299
60060000400821	CI1240-T3WG39	12	4000K	ON/OFF	T3	39	Blanco/Gris	8424450243305
60060000400921	CI1240-APZWG39	12	4000K	ON/OFF	APZ	39	Blanco/Gris	8424450243312
60060000401321	CI1240-SCLWG39	12	4000K	ON/OFF	SCL	39	Blanco/Gris	8424450243336
60060001180121	CI1218D-PWG39	12	PC Ámbar	Dimming	P	39	Blanco/Gris	8424450258392
60060001180521	CI1218D-KWG39	12	PC Ámbar	Dimming	K	39	Blanco/Gris	8424450258408
60060001180621	CI1218D-T2WG39	12	PC Ámbar	Dimming	T2	39	Blanco/Gris	8424450258415
60060001180721	CI1218D-MEWG39	12	PC Ámbar	Dimming	ME	39	Blanco/Gris	8424450258422
60060001180821	CI1218D-T3WG39	12	PC Ámbar	Dimming	T3	39	Blanco/Gris	8424450258439
60060001180921	CI1218D-APZWG39	12	PC Ámbar	Dimming	APZ	39	Blanco/Gris	8424450258446
60060001181321	CI1218D-SCLWG39	12	PC Ámbar	Dimming	SCL	39	Blanco/Gris	8424450258453
60060001220121	CI1222D-PWG39	12	2200K	Dimming	P	39	Blanco/Gris	8424450243626
60060001220521	CI1222D-KWG39	12	2200K	Dimming	K	39	Blanco/Gris	8424450243633
60060001220621	CI1222D-T2WG39	12	2200K	Dimming	T2	39	Blanco/Gris	8424450243640
60060001220721	CI1222D-MEWG39	12	2200K	Dimming	ME	39	Blanco/Gris	8424450243657
60060001220821	CI1222D-T3WG39	12	2200K	Dimming	T3	39	Blanco/Gris	8424450243664
60060001220921	CI1222D-APZWG39	12	2200K	Dimming	APZ	39	Blanco/Gris	8424450243671
60060001221321	CI1222D-SCLWG39	12	2200K	Dimming	SCL	39	Blanco/Gris	8424450243688
60060001300121	CI1230D-PWG39	12	3000K	Dimming	P	39	Blanco/Gris	8424450243763
60060001300521	CI1230D-KWG39	12	3000K	Dimming	K	39	Blanco/Gris	8424450243770
60060001300621	CI1230D-T2WG39	12	3000K	Dimming	T2	39	Blanco/Gris	8424450243787
60060001300721	CI1230D-MEWG39	12	3000K	Dimming	ME	39	Blanco/Gris	8424450243794
60060001300821	CI1230D-T3WG39	12	3000K	Dimming	T3	39	Blanco/Gris	8424450243800
60060001300921	CI1230D-APZWG39	12	3000K	Dimming	APZ	39	Blanco/Gris	8424450243817
60060001301321	CI1230D-SCLWG39	12	3000K	Dimming	SCL	39	Blanco/Gris	8424450243824
60060001400121	CI1240D-PWG39	12	4000K	Dimming	P	39	Blanco/Gris	8424450243831
60060001400521	CI1240D-KWG39	12	4000K	Dimming	K	39	Blanco/Gris	8424450238806
60060001400621	CI1240D-T2WG39	12	4000K	Dimming	T2	39	Blanco/Gris	8424450243848
60060001400721	CI1240D-MEWG39	12	4000K	Dimming	ME	39	Blanco/Gris	8424450243855
60060001400821	CI1240D-T3WG39	12	4000K	Dimming	T3	39	Blanco/Gris	8424450243862
60060001400921	CI1240D-APZWG39	12	4000K	Dimming	APZ	39	Blanco/Gris	8424450243879
60060001401321	CI1240D-SCLWG39	12	4000K	Dimming	SCL	39	Blanco/Gris	8424450243886



ALUMBRADO EXTERIOR INTERURBANO

CIES

REF. PEDIDO	REF. LÓGICA	Nº LEDs		CONTROL	TIPO DE ÓPTICA	POTENCIA (W)		EAN13
Serie E								
60160000180121	CI2418-PWG53	24	PC Ámbar	ON/OFF	P	53	Blanco/Gris	8424450258323
60160000180521	CI2418-KWG53	24	PC Ámbar	ON/OFF	K	53	Blanco/Gris	8424450258330
60160000180621	CI2418-T2WG53	24	PC Ámbar	ON/OFF	T2	53	Blanco/Gris	8424450258347
60160000180721	CI2418-MEWG53	24	PC Ámbar	ON/OFF	ME	53	Blanco/Gris	8424450258354
60160000180821	CI2418-T3WG53	24	PC Ámbar	ON/OFF	T3	53	Blanco/Gris	8424450258361
60160000180921	CI2418-APZWG53	24	PC Ámbar	ON/OFF	APZ	53	Blanco/Gris	8424450258378
60160000181321	CI2418-SCLWG53	24	PC Ámbar	ON/OFF	SCL	53	Blanco/Gris	8424450258385
60160000220121	CI2422-PWG53	24	2200K	ON/OFF	P	53	Blanco/Gris	8424450243343
60160000220521	CI2422-KWG53	24	2200K	ON/OFF	K	53	Blanco/Gris	8424450243350
60160000220621	CI2422-T2WG53	24	2200K	ON/OFF	T2	53	Blanco/Gris	8424450243367
60160000220721	CI2422-MEWG53	24	2200K	ON/OFF	ME	53	Blanco/Gris	8424450243374
60160000220821	CI2422-T3WG53	24	2200K	ON/OFF	T3	53	Blanco/Gris	8424450243381
60160000220921	CI2422-APZWG53	24	2200K	ON/OFF	APZ	53	Blanco/Gris	8424450243398
60160000221321	CI2422-SCLWG53	24	2200K	ON/OFF	SCL	53	Blanco/Gris	8424450243411
60160000300121	CI2430-PWG53	24	3000K	ON/OFF	P	53	Blanco/Gris	8424450240229
60160000300521	CI2430-KWG53	24	3000K	ON/OFF	K	53	Blanco/Gris	8424450243497
60160000300621	CI2430-T2WG53	24	3000K	ON/OFF	T2	53	Blanco/Gris	8424450243503
60160000300721	CI2430-MEWG53	24	3000K	ON/OFF	ME	53	Blanco/Gris	8424450243510
60160000300821	CI2430-T3WG53	24	3000K	ON/OFF	T3	53	Blanco/Gris	8424450243527
60160000300921	CI2430-APZWG53	24	3000K	ON/OFF	APZ	53	Blanco/Gris	8424450243534
60160000301321	CI2430-SCLWG53	24	3000K	ON/OFF	SCL	53	Blanco/Gris	8424450243558
60160000400121	CI2440-PWG53	24	4000K	ON/OFF	P	53	Blanco/Gris	8424450240359
60160000400521	CI2440-KWG53	24	4000K	ON/OFF	K	53	Blanco/Gris	8424450238844
60160000400621	CI2440-T2WG53	24	4000K	ON/OFF	T2	53	Blanco/Gris	8424450243565
60160000400721	CI2440-MEWG53	24	4000K	ON/OFF	ME	53	Blanco/Gris	8424450243572
60160000400821	CI2440-T3WG53	24	4000K	ON/OFF	T3	53	Blanco/Gris	8424450243589
60160000400921	CI2440-APZWG53	24	4000K	ON/OFF	APZ	53	Blanco/Gris	8424450243596
60160000401321	CI2440-SCLWG53	24	4000K	ON/OFF	SCL	53	Blanco/Gris	8424450243619
60160001180121	CI2418D-PWG53	24	PC Ámbar	Dimming	P	53	Blanco/Gris	8424450258460
60160001180521	CI2418D-KWG53	24	PC Ámbar	Dimming	K	53	Blanco/Gris	8424450258477
60160001180621	CI2418D-T2WG53	24	PC Ámbar	Dimming	T2	53	Blanco/Gris	8424450258484
60160001180721	CI2418D-MEWG53	24	PC Ámbar	Dimming	ME	53	Blanco/Gris	8424450258491
60160001180821	CI2418D-T3WG53	24	PC Ámbar	Dimming	T3	53	Blanco/Gris	8424450258507
60160001180921	CI2418D-APZWG53	24	PC Ámbar	Dimming	APZ	53	Blanco/Gris	8424450258514
60160001181321	CI2418D-SCLWG53	24	PC Ámbar	Dimming	SCL	53	Blanco/Gris	8424450258521
60160001220121	CI2422D-PWG53	24	2200K	Dimming	P	53	Blanco/Gris	8424450243893
60160001220521	CI2422D-KWG53	24	2200K	Dimming	K	53	Blanco/Gris	8424450243909
60160001220621	CI2422D-T2WG53	24	2200K	Dimming	T2	53	Blanco/Gris	8424450243916
60160001220721	CI2422D-MEWG53	24	2200K	Dimming	ME	53	Blanco/Gris	8424450243923
60160001220821	CI2422D-T3WG53	24	2200K	Dimming	T3	53	Blanco/Gris	8424450243930
60160001220921	CI2422D-APZWG53	24	2200K	Dimming	APZ	53	Blanco/Gris	8424450243947
60160001221321	CI2422D-SCLWG53	24	2200K	Dimming	SCL	53	Blanco/Gris	8424450243954
60160001300121	CI2430D-PWG53	24	3000K	Dimming	P	53	Blanco/Gris	8424450244036
60160001300521	CI2430D-KWG53	24	3000K	Dimming	K	53	Blanco/Gris	8424450244043
60160001300621	CI2430D-T2WG53	24	3000K	Dimming	T2	53	Blanco/Gris	8424450244050
60160001300721	CI2430D-MEWG53	24	3000K	Dimming	ME	53	Blanco/Gris	8424450244067
60160001300821	CI2430D-T3WG53	24	3000K	Dimming	T3	53	Blanco/Gris	8424450244074
60160001300921	CI2430D-APZWG53	24	3000K	Dimming	APZ	53	Blanco/Gris	8424450244081
60160001301321	CI2430D-SCLWG53	24	3000K	Dimming	SCL	53	Blanco/Gris	8424450244098
60160001400121	CI2440D-PWG53	24	4000K	Dimming	P	53	Blanco/Gris	8424450240465
60160001400521	CI2440D-KWG53	24	4000K	Dimming	K	53	Blanco/Gris	8424450244104
60160001400621	CI2440D-T2WG53	24	4000K	Dimming	T2	53	Blanco/Gris	8424450244111
60160001400721	CI2440D-MEWG53	24	4000K	Dimming	ME	53	Blanco/Gris	8424450244128
60160001400821	CI2440D-T3WG53	24	4000K	Dimming	T3	53	Blanco/Gris	8424450244135
60160001400921	CI2440D-APZWG53	24	4000K	Dimming	APZ	53	Blanco/Gris	8424450244142
60160001401321	CI2440D-SCLWG53	24	4000K	Dimming	SCL	53	Blanco/Gris	8424450244159

ALUMBRADO EXTERIOR INTERURBANO

CIES



REF. PEDIDO	REF. LÓGICA	Nº LEDs	💡	CONTROL	TIPO DE ÓPTICA	POTENCIA (W)	👉	EAN13
Serie E-4								
60060200180121	CI41218-PWG40	12	PC Ámbar	Programable	P	40	Blanco/Gris	8424450258675
60060200180521	CI41218-KWG40	12	PC Ámbar	Programable	K	40	Blanco/Gris	8424450258682
60060200180621	CI41218-T2WG40	12	PC Ámbar	Programable	T2	40	Blanco/Gris	8424450258699
60060200180721	CI41218-MEWG40	12	PC Ámbar	Programable	ME	40	Blanco/Gris	8424450258705
60060200180821	CI41218-T3WG40	12	PC Ámbar	Programable	T3	40	Blanco/Gris	8424450258712
60060200180921	CI41218-APZWG40	12	PC Ámbar	Programable	APZ	40	Blanco/Gris	8424450258729
60060200181321	CI41218-SCLWG40	12	PC Ámbar	Programable	SCL	40	Blanco/Gris	8424450258736
60060200220121	CI41222-PWG40	12	2200K	Programable	P	40	Blanco/Gris	8424450240618
60060200220521	CI41222-KWG40	12	2200K	Programable	K	40	Blanco/Gris	8424450240625
60060200220621	CI41222-T2WG40	12	2200K	Programable	T2	40	Blanco/Gris	8424450240632
60060200220721	CI41222-MEWG40	12	2200K	Programable	ME	40	Blanco/Gris	8424450240649
60060200220821	CI41222-T3WG40	12	2200K	Programable	T3	40	Blanco/Gris	8424450240656
60060200220921	CI41222-APZWG40	12	2200K	Programable	APZ	40	Blanco/Gris	8424450240663
60060200221321	CI41222-SCLWG40	12	2200K	Programable	SCL	40	Blanco/Gris	8424450240670
60060200300121	CI41230-PWG40	12	3000K	Programable	P	40	Blanco/Gris	8424450240540
60060200300521	CI41230-KWG40	12	3000K	Programable	K	40	Blanco/Gris	8424450240557
60060200300621	CI41230-T2WG40	12	3000K	Programable	T2	40	Blanco/Gris	8424450240564
60060200300721	CI41230-MEWG40	12	3000K	Programable	ME	40	Blanco/Gris	8424450240571
60060200300821	CI41230-T3WG40	12	3000K	Programable	T3	40	Blanco/Gris	8424450240588
60060200300921	CI41230-APZWG40	12	3000K	Programable	APZ	40	Blanco/Gris	8424450240595
60060200301321	CI41230-SCLWG40	12	3000K	Programable	SCL	40	Blanco/Gris	8424450240601
60060200400121	CI41240-PWG40	12	4000K	Programable	P	40	Blanco/Gris	8424450240489
60060200400521	CI41240-KWG40	12	4000K	Programable	K	40	Blanco/Gris	8424450238813
60060200400621	CI41240-T2WG40	12	4000K	Programable	T2	40	Blanco/Gris	8424450240496
60060200400721	CI41240-MEWG40	12	4000K	Programable	ME	40	Blanco/Gris	8424450240502
60060200400821	CI41240-T3WG40	12	4000K	Programable	T3	40	Blanco/Gris	8424450240519
60060200400921	CI41240-APZWG40	12	4000K	Programable	APZ	40	Blanco/Gris	8424450240526
60060200401321	CI41240-SCLWG40	12	4000K	Programable	SCL	40	Blanco/Gris	8424450240533
60160200180121	CI42418-PWG70	24	PC Ámbar	Programable	P	70	Blanco/Gris	8424450258743
60160200180521	CI42418-KWG70	24	PC Ámbar	Programable	K	70	Blanco/Gris	8424450258750
60160200180621	CI42418-T2WG70	24	PC Ámbar	Programable	T2	70	Blanco/Gris	8424450258767
60160200180721	CI42418-MEWG70	24	PC Ámbar	Programable	ME	70	Blanco/Gris	8424450258774
60160200180821	CI42418-T3WG70	24	PC Ámbar	Programable	T3	70	Blanco/Gris	8424450258781
60160200180921	CI42418-APZWG70	24	PC Ámbar	Programable	APZ	70	Blanco/Gris	8424450258798
60160200181321	CI42418-SCLWG70	24	PC Ámbar	Programable	SCL	70	Blanco/Gris	8424450258804
60160200220121	CI42422-PWG70	24	2200K	Programable	P	70	Blanco/Gris	8424450240755
60160200220521	CI42422-KWG70	24	2200K	Programable	K	70	Blanco/Gris	8424450240762
60160200220621	CI42422-T2WG70	24	2200K	Programable	T2	70	Blanco/Gris	8424450240779
60160200220721	CI42422-MEWG70	24	2200K	Programable	ME	70	Blanco/Gris	8424450240786
60160200220821	CI42422-T3WG70	24	2200K	Programable	T3	70	Blanco/Gris	8424450240793
60160200220921	CI42422-APZWG70	24	2200K	Programable	APZ	70	Blanco/Gris	8424450240809
60160200221321	CI42422-SCLWG70	24	2200K	Programable	SCL	70	Blanco/Gris	8424450240816
60160200300121	CI42430-PWG70	24	3000K	Programable	P	70	Blanco/Gris	8424450244777
60160200300521	CI42430-KWG70	24	3000K	Programable	K	70	Blanco/Gris	8424450244784
60160200300621	CI42430-T2WG70	24	3000K	Programable	T2	70	Blanco/Gris	8424450244791
60160200300721	CI42430-MEWG70	24	3000K	Programable	ME	70	Blanco/Gris	8424450244807
60160200300821	CI42430-T3WG70	24	3000K	Programable	T3	70	Blanco/Gris	8424450244814
60160200300921	CI42430-APZWG70	24	3000K	Programable	APZ	70	Blanco/Gris	8424450244821
60160200301321	CI42430-SCLWG70	24	3000K	Programable	SCL	70	Blanco/Gris	8424450244845
60160200400121	CI42440-PWG70	24	4000K	Programable	P	70	Blanco/Gris	8424450244852
60160200400521	CI42440-KWG70	24	4000K	Programable	K	70	Blanco/Gris	8424450238868
60160200400621	CI42440-T2WG70	24	4000K	Programable	T2	70	Blanco/Gris	8424450244869
60160200400721	CI42440-MEWG70	24	4000K	Programable	ME	70	Blanco/Gris	8424450244876
60160200400821	CI42440-T3WG70	24	4000K	Programable	T3	70	Blanco/Gris	8424450244883
60160200400921	CI42440-APZWG70	24	4000K	Programable	APZ	70	Blanco/Gris	8424450244890
60160200401321	CI42440-SCLWG70	24	4000K	Programable	SCL	70	Blanco/Gris	8424450244913



ALUMBRADO EXTERIOR INTERURBANO



CIES

REF. PEDIDO	REF. LÓGICA	Nº LEDs		CONTROL	TIPO DE ÓPTICA	POTENCIA (W)		EAN13
Serie N								
60080000180121	CIN1218-PWG39	12	PC Ámbar	Telegestión	P	39	Blanco/Gris	8424450258538
60080000180521	CIN1218-KWG39	12	PC Ámbar	Telegestión	K	39	Blanco/Gris	8424450258545
60080000180621	CIN1218-T2WG39	12	PC Ámbar	Telegestión	T2	39	Blanco/Gris	8424450258552
60080000180721	CIN1218-MEWG39	12	PC Ámbar	Telegestión	ME	39	Blanco/Gris	8424450258569
60080000180821	CIN1218-T3WG39	12	PC Ámbar	Telegestión	T3	39	Blanco/Gris	8424450258576
60080000180921	CIN1218-APZWG39	12	PC Ámbar	Telegestión	APZ	39	Blanco/Gris	8424450258583
60080000181321	CIN1218-SCLWG39	12	PC Ámbar	Telegestión	SCL	39	Blanco/Gris	8424450258590
60080000220121	CIN1222-PWG39	12	2200K	Telegestión	P	39	Blanco/Gris	8424450244166
60080000220521	CIN1222-KWG39	12	2200K	Telegestión	K	39	Blanco/Gris	8424450244173
60080000220621	CIN1222-T2WG39	12	2200K	Telegestión	T2	39	Blanco/Gris	8424450244180
60080000220721	CIN1222-MEWG39	12	2200K	Telegestión	ME	39	Blanco/Gris	8424450244197
60080000220821	CIN1222-T3WG39	12	2200K	Telegestión	T3	39	Blanco/Gris	8424450244203
60080000220921	CIN1222-APZWG39	12	2200K	Telegestión	APZ	39	Blanco/Gris	8424450244210
60080000221321	CIN1222-SCLWG39	12	2200K	Telegestión	SCL	39	Blanco/Gris	8424450244227
60080000300121	CIN1230-PWG39	12	3000K	Telegestión	P	39	Blanco/Gris	8424450244302
60080000300521	CIN1230-KWG39	12	3000K	Telegestión	K	39	Blanco/Gris	8424450244319
60080000300621	CIN1230-T2WG39	12	3000K	Telegestión	T2	39	Blanco/Gris	8424450244326
60080000300721	CIN1230-MEWG39	12	3000K	Telegestión	ME	39	Blanco/Gris	8424450244333
60080000300821	CIN1230-T3WG39	12	3000K	Telegestión	T3	39	Blanco/Gris	8424450244340
60080000300921	CIN1230-APZWG39	12	3000K	Telegestión	APZ	39	Blanco/Gris	8424450244357
60080000301321	CIN1230-SCLWG39	12	3000K	Telegestión	SCL	39	Blanco/Gris	8424450244364
60080000400121	CIN1240-PWG39	12	4000K	Telegestión	P	39	Blanco/Gris	8424450244371
60080000400521	CIN1240-KWG39	12	4000K	Telegestión	K	39	Blanco/Gris	8424450238820
60080000400621	CIN1240-T2WG39	12	4000K	Telegestión	T2	39	Blanco/Gris	8424450244388
60080000400721	CIN1240-MEWG39	12	4000K	Telegestión	ME	39	Blanco/Gris	8424450244395
60080000400821	CIN1240-T3WG39	12	4000K	Telegestión	T3	39	Blanco/Gris	8424450244401
60080000400921	CIN1240-APZWG39	12	4000K	Telegestión	APZ	39	Blanco/Gris	8424450244418
60080000401321	CIN1240-SCLWG39	12	4000K	Telegestión	SCL	39	Blanco/Gris	8424450244425
60180000180121	CIN2418-PWG53	24	PC Ámbar	Telegestión	P	53	Blanco/Gris	8424450258606
60180000180521	CIN2418-KWG53	24	PC Ámbar	Telegestión	K	53	Blanco/Gris	8424450258613
60180000180621	CIN2418-T2WG53	24	PC Ámbar	Telegestión	T2	53	Blanco/Gris	8424450258620
60180000180721	CIN2418-MEWG53	24	PC Ámbar	Telegestión	ME	53	Blanco/Gris	8424450258637
60180000180821	CIN2418-T3WG53	24	PC Ámbar	Telegestión	T3	53	Blanco/Gris	8424450258644
60180000180921	CIN2418-APZWG53	24	PC Ámbar	Telegestión	APZ	53	Blanco/Gris	8424450258651
60180000181321	CIN2418-SCLWG53	24	PC Ámbar	Telegestión	SCL	53	Blanco/Gris	8424450258668
60180000220121	CIN2422-PWG53	24	2200K	Telegestión	P	53	Blanco/Gris	8424450244432
60180000220521	CIN2422-KWG53	24	2200K	Telegestión	K	53	Blanco/Gris	8424450244449
60180000220621	CIN2422-T2WG53	24	2200K	Telegestión	T2	53	Blanco/Gris	8424450244456
60180000220721	CIN2422-MEWG53	24	2200K	Telegestión	ME	53	Blanco/Gris	8424450244463
60180000220821	CIN2422-T3WG53	24	2200K	Telegestión	T3	53	Blanco/Gris	8424450244470
60180000220921	CIN2422-APZWG53	24	2200K	Telegestión	APZ	53	Blanco/Gris	8424450244487
60180000221321	CIN2422-SCLWG53	24	2200K	Telegestión	SCL	53	Blanco/Gris	8424450244494
60180000300121	CIN2430-PWG53	24	3000K	Telegestión	P	53	Blanco/Gris	8424450244579
60180000300521	CIN2430-KWG53	24	3000K	Telegestión	K	53	Blanco/Gris	8424450244586
60180000300621	CIN2430-T2WG53	24	3000K	Telegestión	T2	53	Blanco/Gris	8424450244593
60180000300721	CIN2430-MEWG53	24	3000K	Telegestión	ME	53	Blanco/Gris	8424450244609
60180000300821	CIN2430-T3WG53	24	3000K	Telegestión	T3	53	Blanco/Gris	8424450244616
60180000300921	CIN2430-APZWG53	24	3000K	Telegestión	APZ	53	Blanco/Gris	8424450244623
60180000301321	CIN2430-SCLWG53	24	3000K	Telegestión	SCL	53	Blanco/Gris	8424450244630
60180000400121	CIN2440-PWG53	24	4000K	Telegestión	P	53	Blanco/Gris	8424450244647
60180000400521	CIN2440-KWG53	24	4000K	Telegestión	K	53	Blanco/Gris	8424450238875
60180000400621	CIN2440-T2WG53	24	4000K	Telegestión	T2	53	Blanco/Gris	8424450244654
60180000400721	CIN2440-MEWG53	24	4000K	Telegestión	ME	53	Blanco/Gris	8424450244661
60180000400821	CIN2440-T3WG53	24	4000K	Telegestión	T3	53	Blanco/Gris	8424450244678
60180000400921	CIN2440-APZWG53	24	4000K	Telegestión	APZ	53	Blanco/Gris	8424450244685
60180000401321	CIN2440-SCLWG53	24	4000K	Telegestión	SCL	53	Blanco/Gris	8424450244692

ALUMBRADO EXTERIOR INTERURBANO

CIES





REF. PEDIDO	REF. LÓGICA	Nº LEDs		CONTROL	TIPO DE ÓPTICA	POTENCIA (W)		EAN13
Serie Z								
60090200180121	CIZ1218-PWG40	12	PC Ámbar	Telegestión	P	40	Blanco/Gris	8424450258811
60090200180521	CIZ1218-KWG40	12	PC Ámbar	Telegestión	K	40	Blanco/Gris	8424450258828
60090200180621	CIZ1218-T2WG40	12	PC Ámbar	Telegestión	T2	40	Blanco/Gris	8424450258835
60090200180721	CIZ1218-MEWG40	12	PC Ámbar	Telegestión	ME	40	Blanco/Gris	8424450258842
60090200180821	CIZ1218-T3WG40	12	PC Ámbar	Telegestión	T3	40	Blanco/Gris	8424450258859
60090200180921	CIZ1218-APZWG40	12	PC Ámbar	Telegestión	APZ	40	Blanco/Gris	8424450258866
60090200181321	CIZ1218-SCLWG40	12	PC Ámbar	Telegestión	SCL	40	Blanco/Gris	8424450258873
60090200220121	CIZ1222-PWG40	12	2200K	Telegestión	P	40	Blanco/Gris	8424450258880
60090200220521	CIZ1222-KWG40	12	2200K	Telegestión	K	40	Blanco/Gris	8424450258897
60090200220621	CIZ1222-T2WG40	12	2200K	Telegestión	T2	40	Blanco/Gris	8424450258903
60090200220721	CIZ1222-MEWG40	12	2200K	Telegestión	ME	40	Blanco/Gris	8424450258910
60090200220821	CIZ1222-T3WG40	12	2200K	Telegestión	T3	40	Blanco/Gris	8424450261279
60090200220921	CIZ1222-APZWG40	12	2200K	Telegestión	APZ	40	Blanco/Gris	8424450258927
60090200221321	CIZ1222-SCLWG40	12	2200K	Telegestión	SCL	40	Blanco/Gris	8424450258934
60090200300121	CIZ1230-PWG40	12	3000K	Telegestión	P	40	Blanco/Gris	8424450258941
60090200300521	CIZ1230-KWG40	12	3000K	Telegestión	K	40	Blanco/Gris	8424450258958
60090200300621	CIZ1230-MEWG40	12	3000K	Telegestión	T2	40	Blanco/Gris	8424450258965
60090200300721	CIZ1230-MEWG40	12	3000K	Telegestión	ME	40	Blanco/Gris	8424450258972
60090200300821	CIZ1230-T3WG40	12	3000K	Telegestión	T3	40	Blanco/Gris	8424450258989
60090200300921	CIZ1230-APZWG40	12	3000K	Telegestión	APZ	40	Blanco/Gris	8424450261286
60090200301321	CIZ1230-SCLWG40	12	3000K	Telegestión	SCL	40	Blanco/Gris	8424450258996
60090200400121	CIZ1240-PWG40	12	4000K	Telegestión	P	40	Blanco/Gris	8424450259009
60090200400521	CIZ1240-KWG40	12	4000K	Telegestión	K	40	Blanco/Gris	8424450238837
60090200400621	CIZ1240-T2WG40	12	4000K	Telegestión	T2	40	Blanco/Gris	8424450259016
60090200400721	CIZ1240-MEWG40	12	4000K	Telegestión	ME	40	Blanco/Gris	8424450259023
60090200400821	CIZ1240-T3WG40	12	4000K	Telegestión	T3	40	Blanco/Gris	8424450259030
60090200400921	CIZ1240-APZWG40	12	4000K	Telegestión	APZ	40	Blanco/Gris	8424450259047
60090200401321	CIZ1240-SCLWG40	12	4000K	Telegestión	SCL	40	Blanco/Gris	8424450259054
60190200180121	CIZ2418-PWG70	24	PC Ámbar	Telegestión	P	70	Blanco/Gris	8424450259245
60190200180521	CIZ2418-KWG70	24	PC Ámbar	Telegestión	K	70	Blanco/Gris	8424450259252
60190200180621	CIZ2418-T2WG70	24	PC Ámbar	Telegestión	T2	70	Blanco/Gris	8424450259269
60190200180721	CIZ2418-MEWG70	24	PC Ámbar	Telegestión	ME	70	Blanco/Gris	8424450259344
60190200180821	CIZ2418-T3WG70	24	PC Ámbar	Telegestión	T3	70	Blanco/Gris	8424450259276
60190200180921	CIZ2418-APZWG70	24	PC Ámbar	Telegestión	APZ	70	Blanco/Gris	8424450259283
60190200181321	CIZ2418-SCLWG70	24	PC Ámbar	Telegestión	SCL	70	Blanco/Gris	8424450259290
60190200220121	CIZ2422-PWG70	24	2200K	Telegestión	P	70	Blanco/Gris	8424450259061
60190200220521	CIZ2422-KWG70	24	2200K	Telegestión	K	70	Blanco/Gris	8424450259078
60190200220621	CIZ2422-T2WG70	24	2200K	Telegestión	T2	70	Blanco/Gris	8424450259085
60190200220721	CIZ2422-MEWG70	24	2200K	Telegestión	ME	70	Blanco/Gris	8424450259092
60190200220821	CIZ2422-T3WG70	24	2200K	Telegestión	T3	70	Blanco/Gris	8424450261293
60190200220921	CIZ2422-APZWG70	24	2200K	Telegestión	APZ	70	Blanco/Gris	8424450259108
60190200221321	CIZ2422-SCLWG70	24	2200K	Telegestión	SCL	70	Blanco/Gris	8424450259115
60190200300121	CIZ2430-PWG70	24	3000K	Telegestión	P	70	Blanco/Gris	8424450259122
60190200300521	CIZ2430-KWG70	24	3000K	Telegestión	K	70	Blanco/Gris	8424450259139
60190200300621	CIZ2430-T2WG70	24	3000K	Telegestión	T2	70	Blanco/Gris	8424450259146
60190200300721	CIZ2430-MEWG70	24	3000K	Telegestión	ME	70	Blanco/Gris	8424450259153
60190200300821	CIZ2430-T3WG70	24	3000K	Telegestión	T3	70	Blanco/Gris	8424450259160
60190200300921	CIZ2430-APZWG70	24	3000K	Telegestión	APZ	70	Blanco/Gris	8424450261309
60190200301321	CIZ2430-SCLWG70	24	3000K	Telegestión	SCL	70	Blanco/Gris	8424450259177
60190200400121	CIZ2440-PWG70	24	4000K	Telegestión	P	70	Blanco/Gris	8424450259184
60190200400521	CIZ2440-KWG70	24	4000K	Telegestión	K	70	Blanco/Gris	8424450238882
60190200400621	CIZ2440-T2WG70	24	4000K	Telegestión	T2	70	Blanco/Gris	8424450259191
60190200400721	CIZ2440-MEWG70	24	4000K	Telegestión	ME	70	Blanco/Gris	8424450259207
60190200400821	CIZ2440-T3WG70	24	4000K	Telegestión	T3	70	Blanco/Gris	8424450259214
60190200400921	CIZ2440-APZWG70	24	4000K	Telegestión	APZ	70	Blanco/Gris	8424450259221
60190200401321	CIZ2440-SCLWG70	24	4000K	Telegestión	SCL	70	Blanco/Gris	8424450259238

ALUMBRADO EXTERIOR INTERURBANO



ATMOSLED



REF. PEDIDO	REF. LÓGICA	Nº LEDs		CONTROL	TIPO DE ÓPTICA	POTENCIA (W)		EAN13
Serie E								
68030000180101	AE1218-PAL39	12	PC Ámbar	ON/OFF	P	39	Aluminio	8424450256626
68030000180501	AE1218-KAL39	12	PC Ámbar	ON/OFF	K	39	Aluminio	8424450256633
68030000180601	AE1218-T2AL39	12	PC Ámbar	ON/OFF	T2	39	Aluminio	8424450256640
68030000180701	AE1218-MEAL39	12	PC Ámbar	ON/OFF	ME	39	Aluminio	8424450256657
68030000180801	AE1218-T3AL39	12	PC Ámbar	ON/OFF	T3	39	Aluminio	8424450256664
68030000180901	AE1218-APZAL39	12	PC Ámbar	ON/OFF	APZ	39	Aluminio	8424450256671
68030000181301	AE1218-SCLAL39	12	PC Ámbar	ON/OFF	SCL	39	Aluminio	8424450256688
68030000220101	AE1222-PAL39	12	2200K	ON/OFF	P	39	Aluminio	8424450216934
68030000220501	AE1222-KAL39	12	2200K	ON/OFF	K	39	Aluminio	8424450216941
68030000220601	AE1222-T2AL39	12	2200K	ON/OFF	T2	39	Aluminio	8424450216958
68030000220701	AE1222-MEAL39	12	2200K	ON/OFF	ME	39	Aluminio	8424450216965
68030000220801	AE1222-T3AL39	12	2200K	ON/OFF	T3	39	Aluminio	8424450216972
68030000220901	AE1222-APZAL39	12	2200K	ON/OFF	APZ	39	Aluminio	8424450216989
68030000221301	AE1222-SCLAL39	12	2200K	ON/OFF	SCL	39	Aluminio	8424450256695
68030000300101	AE1230-PAL39	12	3000K	ON/OFF	P	39	Aluminio	8424450213575
68030000300501	AE1230-KAL39	12	3000K	ON/OFF	K	39	Aluminio	8424450216996
68030000300601	AE1230-T2AL39	12	3000K	ON/OFF	T2	39	Aluminio	8424450217009
68030000300701	AE1230-MEAL39	12	3000K	ON/OFF	ME	39	Aluminio	8424450217016
68030000300801	AE1230-T3AL39	12	3000K	ON/OFF	T3	39	Aluminio	8424450217023
68030000300901	AE1230-APZAL39	12	3000K	ON/OFF	APZ	39	Aluminio	8424450217030
68030000301301	AE1230-SCLAL39	12	3000K	ON/OFF	SCL	39	Aluminio	8424450256701
68030000400101	AE1240-PAL39	12	4000K	ON/OFF	P	39	Aluminio	8424450210987
68030000400501	AE1240-KAL39	12	4000K	ON/OFF	K	39	Aluminio	8424450207895
68030000400601	AE1240-T2AL39	12	4000K	ON/OFF	T2	39	Aluminio	8424450217047
68030000400701	AE1240-MEAL39	12	4000K	ON/OFF	ME	39	Aluminio	8424450217054
68030000400801	AE1240-T3AL39	12	4000K	ON/OFF	T3	39	Aluminio	8424450217061
68030000400901	AE1240-APZAL39	12	4000K	ON/OFF	APZ	39	Aluminio	8424450214923
68030000401301	AE1240-SCLAL39	12	4000K	ON/OFF	SCL	39	Aluminio	8424450256404
68030001180101	AE1218D-PAL39	12	PC Ámbar	Dimming	P	39	Aluminio	8424450257005
68030001180501	AE1218D-KAL39	12	PC Ámbar	Dimming	K	39	Aluminio	8424450257012
68030001180601	AE1218D-T2AL39	12	PC Ámbar	Dimming	T2	39	Aluminio	8424450257029
68030001180701	AE1218D-MEAL39	12	PC Ámbar	Dimming	ME	39	Aluminio	8424450257036
68030001180801	AE1218D-T3AL39	12	PC Ámbar	Dimming	T3	39	Aluminio	8424450257043
68030001180901	AE1218D-APZAL39	12	PC Ámbar	Dimming	APZ	39	Aluminio	8424450257050
68030001181301	AE1218D-SCLAL39	12	PC Ámbar	Dimming	SCL	39	Aluminio	8424450257067
68030001220101	AE1222D-PAL39	12	2200K	Dimming	P	39	Aluminio	8424450209196
68030001220501	AE1222D-KAL39	12	2200K	Dimming	K	39	Aluminio	8424450207901
68030001220601	AE1222D-T2AL39	12	2200K	Dimming	T2	39	Aluminio	8424450216743
68030001220701	AE1222D-MEAL39	12	2200K	Dimming	ME	39	Aluminio	8424450216750
68030001220801	AE1222D-T3AL39	12	2200K	Dimming	T3	39	Aluminio	8424450216767
68030001220901	AE1222D-APZAL39	12	2200K	Dimming	APZ	39	Aluminio	8424450216774
68030001221301	AE1222D-SCLAL39	12	2200K	Dimming	SCL	39	Aluminio	8424450257074
68030001300101	AE1230D-PAL39	12	3000K	Dimming	P	39	Aluminio	8424450216781
68030001300501	AE1230D-KAL39	12	3000K	Dimming	K	39	Aluminio	8424450207918
68030001300601	AE1230D-T2AL39	12	3000K	Dimming	T2	39	Aluminio	8424450216798
68030001300701	AE1230D-MEAL39	12	3000K	Dimming	ME	39	Aluminio	8424450216804
68030001300801	AE1230D-T3AL39	12	3000K	Dimming	T3	39	Aluminio	8424450216811
68030001300901	AE1230D-APZAL39	12	3000K	Dimming	APZ	39	Aluminio	8424450216828
68030001301301	AE1230D-SCLAL39	12	3000K	Dimming	SCL	39	Aluminio	8424450257081
68030001400101	AE1240D-PAL39	12	4000K	Dimming	P	39	Aluminio	8424450212226
68030001400501	AE1240D-KAL39	12	4000K	Dimming	K	39	Aluminio	8424450207147
68030001400601	AE1240D-T2AL39	12	4000K	Dimming	T2	39	Aluminio	8424450216835
68030001400701	AE1240D-MEAL39	12	4000K	Dimming	ME	39	Aluminio	8424450216842
68030001400801	AE1240D-T3AL39	12	4000K	Dimming	T3	39	Aluminio	8424450216859
68030001400901	AE1240D-APZAL39	12	4000K	Dimming	APZ	39	Aluminio	8424450216866
68030001401301	AE1240D-SCLAL39	12	4000K	Dimming	SCL	39	Aluminio	8424450252390

ATMOSLED





REF. PEDIDO	REF. LÓGICA	Nº LEDs		CONTROL	TIPO DE ÓPTICA	POTENCIA (W)		EAN13
Serie E								
68130000180101	AE2418-PAL58	24	PC Ámbar	ON/OFF	P	58	Aluminio	8424450256718
68130000180501	AE2418-KAL58	24	PC Ámbar	ON/OFF	K	58	Aluminio	8424450256725
68130000180601	AE2418-T2AL58	24	PC Ámbar	ON/OFF	T2	58	Aluminio	8424450256732
68130000180701	AE2418-MEAL58	24	PC Ámbar	ON/OFF	ME	58	Aluminio	8424450256749
68130000180801	AE2418-T3AL58	24	PC Ámbar	ON/OFF	T3	58	Aluminio	8424450256756
68130000180901	AE2418-APZAL58	24	PC Ámbar	ON/OFF	APZ	58	Aluminio	8424450256763
68130000181301	AE2418-SCLAL58	24	PC Ámbar	ON/OFF	SCL	58	Aluminio	8424450265567
68130000220101	AE2422-PAL58	24	2200K	ON/OFF	P	58	Aluminio	8424450213209
68130000220501	AE2422-KAL58	24	2200K	ON/OFF	K	58	Aluminio	8424450217313
68130000220601	AE2422-T2AL58	24	2200K	ON/OFF	T2	58	Aluminio	8424450217320
68130000220701	AE2422-MEAL58	24	2200K	ON/OFF	ME	58	Aluminio	8424450217337
68130000220801	AE2422-T3AL58	24	2200K	ON/OFF	T3	58	Aluminio	8424450217344
68130000220901	AE2422-APZAL58	24	2200K	ON/OFF	APZ	58	Aluminio	8424450217351
68130000221301	AE2422-SCLAL58	24	2200K	ON/OFF	SCL	58	Aluminio	8424450256770
68130000300101	AE2430-PAL58	24	3000K	ON/OFF	P	58	Aluminio	8424450214725
68130000300501	AE2430-KAL58	24	3000K	ON/OFF	K	58	Aluminio	8424450219263
68130000300601	AE2430-T2AL58	24	3000K	ON/OFF	T2	58	Aluminio	8424450219270
68130000300701	AE2430-MEAL58	24	3000K	ON/OFF	ME	58	Aluminio	8424450219287
68130000300801	AE2430-T3AL58	24	3000K	ON/OFF	T3	58	Aluminio	8424450219294
68130000300901	AE2430-APZAL58	24	3000K	ON/OFF	APZ	58	Aluminio	8424450219300
68130000301301	AE2430-SCLAL58	24	3000K	ON/OFF	SCL	58	Aluminio	8424450256787
68130000400101	AE2440-PAL58	24	4000K	ON/OFF	P	58	Aluminio	8424450214619
68130000400501	AE2440-KAL58	24	4000K	ON/OFF	K	58	Aluminio	8424450207925
68130000400601	AE2440-T2AL58	24	4000K	ON/OFF	T2	58	Aluminio	8424450219317
68130000400701	AE2440-MEAL58	24	4000K	ON/OFF	ME	58	Aluminio	8424450219324
68130000400801	AE2440-T3AL58	24	4000K	ON/OFF	T3	58	Aluminio	8424450213926
68130000400901	AE2440-APZAL58	24	4000K	ON/OFF	APZ	58	Aluminio	8424450219331
68130000401301	AE2440-SCLAL58	24	4000K	ON/OFF	SCL	58	Aluminio	8424450256794
68130001180101	AE2418D-PAL58	24	PC Ámbar	Dimming	P	58	Aluminio	8424450257098
68130001180501	AE2418D-KAL58	24	PC Ámbar	Dimming	K	58	Aluminio	8424450257104
68130001180601	AE2418D-T2AL58	24	PC Ámbar	Dimming	T2	58	Aluminio	8424450257111
68130001180701	AE2418D-MEAL58	24	PC Ámbar	Dimming	ME	58	Aluminio	8424450257128
68130001180801	AE2418D-T3AL58	24	PC Ámbar	Dimming	T3	58	Aluminio	8424450257135
68130001180901	AE2418D-APZAL58	24	PC Ámbar	Dimming	APZ	58	Aluminio	8424450257142
68130001181301	AE2418D-SCLAL58	24	PC Ámbar	Dimming	SCL	58	Aluminio	8424450257159
68130001220101	AE2422D-PAL58	24	2200K	Dimming	P	58	Aluminio	8424450213636
68130001220501	AE2422D-KAL58	24	2200K	Dimming	K	58	Aluminio	8424450207932
68130001220601	AE2422D-T2AL58	24	2200K	Dimming	T2	58	Aluminio	8424450209257
68130001220701	AE2422D-MEAL58	24	2200K	Dimming	ME	58	Aluminio	8424450217146
68130001220801	AE2422D-T3AL58	24	2200K	Dimming	T3	58	Aluminio	8424450217153
68130001220901	AE2422D-APZAL58	24	2200K	Dimming	APZ	58	Aluminio	8424450217160
68130001221301	AE2422D-SCLAL58	24	2200K	Dimming	SCL	58	Aluminio	8424450257166
68130001300101	AE2430D-PAL58	24	3000K	Dimming	P	58	Aluminio	8424450217177
68130001300501	AE2430D-KAL58	24	3000K	Dimming	K	58	Aluminio	8424450207949
68130001300601	AE2430D-T2AL58	24	3000K	Dimming	T2	58	Aluminio	8424450217184
68130001300701	AE2430D-MEAL58	24	3000K	Dimming	ME	58	Aluminio	8424450217191
68130001300801	AE2430D-T3AL58	24	3000K	Dimming	T3	58	Aluminio	8424450217207
68130001300901	AE2430D-APZAL58	24	3000K	Dimming	APZ	58	Aluminio	8424450217214
68130001301301	AE2430D-SCLAL58	24	3000K	Dimming	SCL	58	Aluminio	8424450257173
68130001400101	AE2440D-PAL58	24	4000K	Dimming	P	58	Aluminio	8424450212219
68130001400501	AE2440D-KAL58	24	4000K	Dimming	K	58	Aluminio	8424450207154
68130001400601	AE2440D-T2AL58	24	4000K	Dimming	T2	58	Aluminio	8424450209202
68130001400701	AE2440D-MEAL58	24	4000K	Dimming	ME	58	Aluminio	8424450217221
68130001400801	AE2440D-T3AL58	24	4000K	Dimming	T3	58	Aluminio	8424450217238
68130001400901	AE2440D-APZAL58	24	4000K	Dimming	APZ	58	Aluminio	8424450217245
68130001401301	AE2440D-SCLAL58	24	4000K	Dimming	SCL	58	Aluminio	8424450257180

ALUMBRADO EXTERIOR INTERURBANO



ATMOSLED



REF. PEDIDO	REF. LÓGICA	Nº LEDs		CONTROL	TIPO DE ÓPTICA	POTENCIA (W)		EAN13
Serie E								
68230000180101	AE3618-PAL78	36	PC Ámbar	ON/OFF	P	78	Aluminio	8424450256800
68230000180501	AE3618-KAL78	36	PC Ámbar	ON/OFF	K	78	Aluminio	8424450256817
68230000180601	AE3618-T2AL78	36	PC Ámbar	ON/OFF	T2	78	Aluminio	8424450256824
68230000180701	AE3618-MEAL78	36	PC Ámbar	ON/OFF	ME	78	Aluminio	8424450256831
68230000180801	AE3618-T3AL78	36	PC Ámbar	ON/OFF	T3	78	Aluminio	8424450256848
68230000180901	AE3618-APZAL78	36	PC Ámbar	ON/OFF	APZ	78	Aluminio	8424450256855
68230000181301	AE3618-SCLAL78	36	PC Ámbar	ON/OFF	SCL	78	Aluminio	8424450256862
68230000220101	AE3622-PAL78	36	2200K	ON/OFF	P	78	Aluminio	8424450218082
68230000220501	AE3622-KAL78	36	2200K	ON/OFF	K	78	Aluminio	8424450218099
68230000220601	AE3622-T2AL78	36	2200K	ON/OFF	T2	78	Aluminio	8424450218129
68230000220701	AE3622-MEAL78	36	2200K	ON/OFF	ME	78	Aluminio	8424450218136
68230000220801	AE3622-T3AL78	36	2200K	ON/OFF	T3	78	Aluminio	8424450218204
68230000220901	AE3622-APZAL78	36	2200K	ON/OFF	APZ	78	Aluminio	8424450218211
68230000221301	AE3622-SCLAL78	36	2200K	ON/OFF	SCL	78	Aluminio	8424450256879
68230000300101	AE3630-PAL78	36	3000K	ON/OFF	P	78	Aluminio	8424450213032
68230000300501	AE3630-KAL78	36	3000K	ON/OFF	K	78	Aluminio	8424450218105
68230000300601	AE3630-T2AL78	36	3000K	ON/OFF	T2	78	Aluminio	8424450218143
68230000300701	AE3630-MEAL78	36	3000K	ON/OFF	ME	78	Aluminio	8424450218150
68230000300801	AE3630-T3AL78	36	3000K	ON/OFF	T3	78	Aluminio	8424450218228
68230000300901	AE3630-APZAL78	36	3000K	ON/OFF	APZ	78	Aluminio	8424450218235
68230000301301	AE3630-SCLAL78	36	3000K	ON/OFF	SCL	78	Aluminio	8424450256886
68230000400101	AE3640-PAL78	36	4000K	ON/OFF	P	78	Aluminio	8424450212400
68230000400501	AE3640-KAL78	36	4000K	ON/OFF	K	78	Aluminio	8424450211687
68230000400601	AE3640-T2AL78	36	4000K	ON/OFF	T2	78	Aluminio	8424450218167
68230000400701	AE3640-MEAL78	36	4000K	ON/OFF	ME	78	Aluminio	8424450218174
68230000400801	AE3640-T3AL78	36	4000K	ON/OFF	T3	78	Aluminio	8424450218242
68230000400901	AE3640-APZAL78	36	4000K	ON/OFF	APZ	78	Aluminio	8424450218259
68230000401301	AE3640-SCLAL78	36	4000K	ON/OFF	SCL	78	Aluminio	8424450256893
68230001180101	AE3618D-PAL78	36	PC Ámbar	Dimming	P	78	Aluminio	8424450257197
68230001180501	AE3618D-KAL78	36	PC Ámbar	Dimming	K	78	Aluminio	8424450257203
68230001180601	AE3618D-T2AL78	36	PC Ámbar	Dimming	T2	78	Aluminio	8424450257210
68230001180701	AE3618D-MEAL78	36	PC Ámbar	Dimming	ME	78	Aluminio	8424450257227
68230001180801	AE3618D-T3AL78	36	PC Ámbar	Dimming	T3	78	Aluminio	8424450257234
68230001180901	AE3618D-APZAL78	36	PC Ámbar	Dimming	APZ	78	Aluminio	8424450257241
68230001181301	AE3618D-SCLAL78	36	PC Ámbar	Dimming	SCL	78	Aluminio	8424450257258
68230001220101	AE3622D-PAL78	36	2200K	Dimming	P	78	Aluminio	8424450218280
68230001220501	AE3622D-KAL78	36	2200K	Dimming	K	78	Aluminio	8424450207956
68230001220601	AE3622D-T2AL78	36	2200K	Dimming	T2	78	Aluminio	8424450218310
68230001220701	AE3622D-MEAL78	36	2200K	Dimming	ME	78	Aluminio	8424450209264
68230001220801	AE3622D-T3AL78	36	2200K	Dimming	T3	78	Aluminio	8424450231395
68230001220901	AE3622D-APZAL78	36	2200K	Dimming	APZ	78	Aluminio	8424450218372
68230001221301	AE3622D-SCLAL78	36	2200K	Dimming	SCL	78	Aluminio	8424450257265
68230001300101	AE3630D-PAL78	36	3000K	Dimming	P	78	Aluminio	8424450213124
68230001300501	AE3630D-KAL78	36	3000K	Dimming	K	78	Aluminio	8424450207963
68230001300601	AE3630D-T2AL78	36	3000K	Dimming	T2	78	Aluminio	8424450218327
68230001300701	AE3630D-MEAL78	36	3000K	Dimming	ME	78	Aluminio	8424450218334
68230001300801	AE3630D-T3AL78	36	3000K	Dimming	T3	78	Aluminio	8424450231401
68230001300901	AE3630D-APZAL78	36	3000K	Dimming	APZ	78	Aluminio	8424450218389
68230001301301	AE3630D-SCLAL78	36	3000K	Dimming	SCL	78	Aluminio	8424450257272
68230001400101	AE3640D-PAL78	36	4000K	Dimming	P	78	Aluminio	8424450212202
68230001400501	AE3640D-KAL78	36	4000K	Dimming	K	78	Aluminio	8424450207161
68230001400601	AE3640D-T2AL78	36	4000K	Dimming	T2	78	Aluminio	8424450218341
68230001400701	AE3640D-MEAL78	36	4000K	Dimming	ME	78	Aluminio	8424450209219
68230001400801	AE3640D-T3AL78	36	4000K	Dimming	T3	78	Aluminio	8424450231418
68230001400901	AE3640D-APZAL78	36	4000K	Dimming	APZ	78	Aluminio	8424450218396
68230001401301	AE3640D-SCLAL78	36	4000K	Dimming	SCL	78	Aluminio	8424450257289

ATMOSLED





REF. PEDIDO	REF. LÓGICA	Nº LEDs		CONTROL	TIPO DE ÓPTICA	POTENCIA (W)		EAN13
Serie E								
68330000180101	AE4818-PAL108	48	PC Ámbar	ON/OFF	P	108	Aluminio	8424450256909
68330000180501	AE4818-KAL108	48	PC Ámbar	ON/OFF	K	108	Aluminio	8424450256916
68330000180601	AE4818-T2AL108	48	PC Ámbar	ON/OFF	T2	108	Aluminio	8424450256923
68330000180701	AE4818-MEAL108	48	PC Ámbar	ON/OFF	ME	108	Aluminio	8424450256930
68330000180801	AE4818-T3AL108	48	PC Ámbar	ON/OFF	T3	108	Aluminio	8424450256947
68330000180901	AE4818-APZAL108	48	PC Ámbar	ON/OFF	APZ	108	Aluminio	8424450256954
68330000181301	AE4818-SCLAL108	48	PC Ámbar	ON/OFF	SCL	108	Aluminio	8424450256961
68330000220101	AE4822-PAL108	48	2200K	ON/OFF	P	108	Aluminio	8424450213865
68330000220501	AE4822-KAL108	48	2200K	ON/OFF	K	108	Aluminio	8424450218419
68330000220601	AE4822-T2AL108	48	2200K	ON/OFF	T2	108	Aluminio	8424450218457
68330000220701	AE4822-MEAL108	48	2200K	ON/OFF	ME	108	Aluminio	8424450218464
68330000220801	AE4822-T3AL108	48	2200K	ON/OFF	T3	108	Aluminio	8424450218532
68330000220901	AE4822-APZAL108	48	2200K	ON/OFF	APZ	108	Aluminio	8424450218549
68330000221301	AE4822-SCLAL108	48	2200K	ON/OFF	SCL	108	Aluminio	8424450256978
68330000300101	AE4830-PAL108	48	3000K	ON/OFF	P	108	Aluminio	8424450213049
68330000300501	AE4830-KAL108	48	3000K	ON/OFF	K	108	Aluminio	8424450218426
68330000300601	AE4830-T2AL108	48	3000K	ON/OFF	T2	108	Aluminio	8424450218471
68330000300701	AE4830-MEAL108	48	3000K	ON/OFF	ME	108	Aluminio	8424450218488
68330000300801	AE4830-T3AL108	48	3000K	ON/OFF	T3	108	Aluminio	8424450218556
68330000300901	AE4830-APZAL108	48	3000K	ON/OFF	APZ	108	Aluminio	8424450218563
68330000301301	AE4830-SCLAL108	48	3000K	ON/OFF	SCL	108	Aluminio	8424450256985
68330000400101	AE4840-PAL108	48	4000K	ON/OFF	P	108	Aluminio	8424450214602
68330000400501	AE4840-KAL108	48	4000K	ON/OFF	K	108	Aluminio	8424450210390
68330000400601	AE4840-T2AL108	48	4000K	ON/OFF	T2	108	Aluminio	8424450218495
68330000400701	AE4840-MEAL108	48	4000K	ON/OFF	ME	108	Aluminio	8424450218501
68330000400801	AE4840-T3AL108	48	4000K	ON/OFF	T3	108	Aluminio	8424450218570
68330000400901	AE4840-APZAL108	48	4000K	ON/OFF	APZ	108	Aluminio	8424450218587
68330000401301	AE4840-SCLAL108	48	4000K	ON/OFF	SCL	108	Aluminio	8424450256992
68330001180101	AE4818D-PAL108	48	PC Ámbar	Dimming	P	108	Aluminio	8424450257296
68330001180501	AE4818D-KAL108	48	PC Ámbar	Dimming	K	108	Aluminio	8424450257302
68330001180601	AE4818D-T2AL108	48	PC Ámbar	Dimming	T2	108	Aluminio	8424450257319
68330001180701	AE4818D-MEAL108	48	PC Ámbar	Dimming	ME	108	Aluminio	8424450257326
68330001180801	AE4818D-T3AL108	48	PC Ámbar	Dimming	T3	108	Aluminio	8424450257333
68330001180901	AE4818D-APZAL108	48	PC Ámbar	Dimming	APZ	108	Aluminio	8424450257340
68330001181301	AE4818D-SCLAL108	48	PC Ámbar	Dimming	SCL	108	Aluminio	8424450257357
68330001220101	AE4822D-PAL108	48	2200K	Dimming	P	108	Aluminio	8424450218617
68330001220501	AE4822D-KAL108	48	2200K	Dimming	K	108	Aluminio	8424450207970
68330001220601	AE4822D-T2AL108	48	2200K	Dimming	T2	108	Aluminio	8424450218624
68330001220701	AE4822D-MEAL108	48	2200K	Dimming	ME	108	Aluminio	8424450218693
68330001220801	AE4822D-T3AL108	48	2200K	Dimming	T3	108	Aluminio	8424450209271
68330001220901	AE4822D-APZAL108	48	2200K	Dimming	APZ	108	Aluminio	8424450213650
68330001221301	AE4822D-SCLAL108	48	2200K	Dimming	SCL	108	Aluminio	8424450257364
68330001300101	AE4830D-PAL108	48	3000K	Dimming	P	108	Aluminio	8424450213131
68330001300501	AE4830D-KAL108	48	3000K	Dimming	K	108	Aluminio	8424450207987
68330001300601	AE4830D-T2AL108	48	3000K	Dimming	T2	108	Aluminio	8424450218631
68330001300701	AE4830D-MEAL108	48	3000K	Dimming	ME	108	Aluminio	8424450218709
68330001300801	AE4830D-T3AL108	48	3000K	Dimming	T3	108	Aluminio	8424450218716
68330001300901	AE4830D-APZAL108	48	3000K	Dimming	APZ	108	Aluminio	8424450218723
68330001301301	AE4830D-SCLAL108	48	3000K	Dimming	SCL	108	Aluminio	8424450257371
68330001400101	AE4840D-PAL108	48	4000K	Dimming	P	108	Aluminio	8424450218648
68330001400501	AE4840D-KAL108	48	4000K	Dimming	K	108	Aluminio	8424450207178
68330001400601	AE4840D-T2AL108	48	4000K	Dimming	T2	108	Aluminio	8424450218655
68330001400701	AE4840D-MEAL108	48	4000K	Dimming	ME	108	Aluminio	8424450218730
68330001400801	AE4840D-T3AL108	48	4000K	Dimming	T3	108	Aluminio	8424450209226
68330001400901	AE4840D-APZAL108	48	4000K	Dimming	APZ	108	Aluminio	8424450213643
68330001401301	AE4840D-SCLAL108	48	4000K	Dimming	SCL	108	Aluminio	8424450257388

ALUMBRADO EXTERIOR INTERURBANO



ATMOSLED



REF. PEDIDO	REF. LÓGICA	Nº LEDs		CONTROL	TIPO DE ÓPTICA	POTENCIA (W)		EAN13
Serie E-4								
68030200180101	AE41218-PAL40	12	PC Ámbar	Programable	P	40	Aluminio	8424450257395
68030200180501	AE41218-KAL40	12	PC Ámbar	Programable	K	40	Aluminio	8424450257401
68030200180601	AE41218-T2AL40	12	PC Ámbar	Programable	T2	40	Aluminio	8424450257418
68030200180701	AE41218-MEAL40	12	PC Ámbar	Programable	ME	40	Aluminio	8424450265109
68030200180801	AE41218-T3AL40	12	PC Ámbar	Programable	T3	40	Aluminio	8424450257425
68030200180901	AE41218-APZAL40	12	PC Ámbar	Programable	APZ	40	Aluminio	8424450257432
68030200181301	AE41218-SCLAL40	12	PC Ámbar	Programable	SCL	40	Aluminio	8424450257449
68030200220101	AE41222-PAL40	12	2200K	Programable	P	40	Aluminio	8424450240960
68030200220501	AE41222-KAL40	12	2200K	Programable	K	40	Aluminio	8424450240977
68030200220601	AE41222-T2AL40	12	2200K	Programable	T2	40	Aluminio	8424450240984
68030200220701	AE41222-MEAL40	12	2200K	Programable	ME	40	Aluminio	8424450240991
68030200220801	AE41222-T3AL40	12	2200K	Programable	T3	40	Aluminio	8424450241004
68030200220901	AE41222-APZAL40	12	2200K	Programable	APZ	40	Aluminio	8424450241011
68030200221301	AE41222-SCLAL40	12	2200K	Programable	SCL	40	Aluminio	8424450241028
68030200300101	AE41230-PAL40	12	3000K	Programable	P	40	Aluminio	8424450241257
68030200300501	AE41230-KAL40	12	3000K	Programable	K	40	Aluminio	8424450241264
68030200300601	AE41230-T2AL40	12	3000K	Programable	T2	40	Aluminio	8424450241271
68030200300701	AE41230-MEAL40	12	3000K	Programable	ME	40	Aluminio	8424450241288
68030200300801	AE41230-T3AL40	12	3000K	Programable	T3	40	Aluminio	8424450241578
68030200300901	AE41230-APZAL40	12	3000K	Programable	APZ	40	Aluminio	8424450241585
68030200301301	AE41230-SCLAL40	12	3000K	Programable	SCL	40	Aluminio	8424450241592
68030200400101	AE41240-PAL40	12	4000K	Programable	P	40	Aluminio	8424450241608
68030200400501	AE41240-KAL40	12	4000K	Programable	K	40	Aluminio	8424450241615
68030200400601	AE41240-T2AL40	12	4000K	Programable	T2	40	Aluminio	8424450241622
68030200400701	AE41240-MEAL40	12	4000K	Programable	ME	40	Aluminio	8424450241639
68030200400801	AE41240-T3AL40	12	4000K	Programable	T3	40	Aluminio	8424450241646
68030200400901	AE41240-APZAL40	12	4000K	Programable	APZ	40	Aluminio	8424450241653
68030200401301	AE41240-SCLAL40	12	4000K	Programable	SCL	40	Aluminio	8424450241660
68130200180101	AE42418-PAL60	24	PC Ámbar	Programable	P	60	Aluminio	8424450257456
68130200180501	AE42418-KAL60	24	PC Ámbar	Programable	K	60	Aluminio	8424450257463
68130200180601	AE42418-T2AL60	24	PC Ámbar	Programable	T2	60	Aluminio	8424450257470
68130200180701	AE42418-MEAL60	24	PC Ámbar	Programable	ME	60	Aluminio	8424450257487
68130200180801	AE42418-T3AL60	24	PC Ámbar	Programable	T3	60	Aluminio	8424450257494
68130200180901	AE42418-APZAL60	24	PC Ámbar	Programable	APZ	60	Aluminio	8424450257500
68130200181301	AE42418-SCLAL60	24	PC Ámbar	Programable	SCL	60	Aluminio	8424450257517
68130200220101	AE42422-PAL60	24	2200K	Programable	P	60	Aluminio	8424450241103
68130200220501	AE42422-KAL60	24	2200K	Programable	K	60	Aluminio	8424450241110
68130200220601	AE42422-T2AL60	24	2200K	Programable	T2	60	Aluminio	8424450241127
68130200220701	AE42422-MEAL60	24	2200K	Programable	ME	60	Aluminio	8424450241134
68130200220801	AE42422-T3AL60	24	2200K	Programable	T3	60	Aluminio	8424450241141
68130200220901	AE42422-APZAL60	24	2200K	Programable	APZ	60	Aluminio	8424450241158
68130200221301	AE42422-SCLAL60	24	2200K	Programable	SCL	60	Aluminio	8424450241165
68130200300101	AE42430-PAL60	24	3000K	Programable	P	60	Aluminio	8424450241349
68130200300501	AE42430-KAL60	24	3000K	Programable	K	60	Aluminio	8424450241356
68130200300601	AE42430-T2AL60	24	3000K	Programable	T2	60	Aluminio	8424450241363
68130200300701	AE42430-MEAL60	24	3000K	Programable	ME	60	Aluminio	8424450241370
68130200300801	AE42430-T3AL60	24	3000K	Programable	T3	60	Aluminio	8424450241387
68130200300901	AE42430-APZAL60	24	3000K	Programable	APZ	60	Aluminio	8424450241394
68130200301301	AE42430-SCLAL60	24	3000K	Programable	SCL	60	Aluminio	8424450241400
68130200400101	AE42440-PAL60	24	4000K	Programable	P	60	Aluminio	8424450241417
68130200400501	AE42440-KAL60	24	4000K	Programable	K	60	Aluminio	8424450241424
68130200400601	AE42440-T2AL60	24	4000K	Programable	T2	60	Aluminio	8424450241431
68130200400701	AE42440-MEAL60	24	4000K	Programable	ME	60	Aluminio	8424450241448
68130200400801	AE42440-T3AL60	24	4000K	Programable	T3	60	Aluminio	8424450241455
68130200400901	AE42440-APZAL60	24	4000K	Programable	APZ	60	Aluminio	8424450241462
68130200401301	AE42440-SCLAL60	24	4000K	Programable	SCL	60	Aluminio	8424450241479

ATMOSLED



REF. PEDIDO	REF. LÓGICA	Nº LEDs		CONTROL	TIPO DE ÓPTICA	POTENCIA (W)		EAN13
Serie E-4								
68230200180101	AE43618-PAL77	36	PC Ámbar	Programable	P	77	Aluminio	8424450257524
68230200180501	AE43618-KAL77	36	PC Ámbar	Programable	K	77	Aluminio	8424450257531
68230200180601	AE43618-T2AL77	36	PC Ámbar	Programable	T2	77	Aluminio	8424450265314
68230200180701	AE43618-MEAL77	36	PC Ámbar	Programable	ME	77	Aluminio	8424450257548
68230200180801	AE43618-T3AL77	36	PC Ámbar	Programable	T3	77	Aluminio	8424450257555
68230200180901	AE43618-APZAL77	36	PC Ámbar	Programable	APZ	77	Aluminio	8424450257562
68230200181301	AE43618-SCLAL77	36	PC Ámbar	Programable	SCL	77	Aluminio	8424450257579
68230200220101	AE43622-PAL77	36	2200K	Programable	P	77	Aluminio	8424450241486
68230200220501	AE43622-KAL77	36	2200K	Programable	K	77	Aluminio	8424450241493
68230200220601	AE43622-T2AL77	36	2200K	Programable	T2	77	Aluminio	8424450241509
68230200220701	AE43622-MEAL77	36	2200K	Programable	ME	77	Aluminio	8424450241516
68230200220801	AE43622-T3AL77	36	2200K	Programable	T3	77	Aluminio	8424450241523
68230200220901	AE43622-APZAL77	36	2200K	Programable	APZ	77	Aluminio	8424450241530
68230200221301	AE43622-SCLAL77	36	2200K	Programable	SCL	77	Aluminio	8424450241547
68230200300101	AE43630-PAL77	36	3000K	Programable	P	77	Aluminio	8424450241677
68230200300501	AE43630-KAL77	36	3000K	Programable	K	77	Aluminio	8424450241684
68230200300601	AE43630-T2AL77	36	3000K	Programable	T2	77	Aluminio	8424450241691
68230200300701	AE43630-MEAL77	36	3000K	Programable	ME	77	Aluminio	8424450241707
68230200300801	AE43630-T3AL77	36	3000K	Programable	T3	77	Aluminio	8424450241714
68230200300901	AE43630-APZAL77	36	3000K	Programable	APZ	77	Aluminio	8424450241721
68230200301301	AE43630-SCLAL77	36	3000K	Programable	SCL	77	Aluminio	8424450241738
68230200400101	AE43640-PAL77	36	4000K	Programable	P	77	Aluminio	8424450241806
68230200400501	AE43640-KAL77	36	4000K	Programable	K	77	Aluminio	8424450241813
68230200400601	AE43640-T2AL77	36	4000K	Programable	T2	77	Aluminio	8424450241820
68230200400701	AE43640-MEAL77	36	4000K	Programable	ME	77	Aluminio	8424450241837
68230200400801	AE43640-T3AL77	36	4000K	Programable	T3	77	Aluminio	8424450241844
68230200400901	AE43640-APZAL77	36	4000K	Programable	APZ	77	Aluminio	8424450241851
68230200401301	AE43640-SCLAL77	36	4000K	Programable	SCL	77	Aluminio	8424450241868
68330200180101	AE44818-PAL109	48	PC Ámbar	Programable	P	109	Aluminio	8424450257586
68330200180501	AE44818-KAL109	48	PC Ámbar	Programable	K	109	Aluminio	8424450257593
68330200180601	AE44818-T2AL109	48	PC Ámbar	Programable	T2	109	Aluminio	8424450257609
68330200180701	AE44818-MEAL109	48	PC Ámbar	Programable	ME	109	Aluminio	8424450257616
68330200180801	AE44818-T3AL109	48	PC Ámbar	Programable	T3	109	Aluminio	8424450257623
68330200180901	AE44818-APZAL109	48	PC Ámbar	Programable	APZ	109	Aluminio	8424450257630
68330200181301	AE44818-SCLAL109	48	PC Ámbar	Programable	SCL	109	Aluminio	8424450257647
68330200220101	AE44822-PAL109	48	2200K	Programable	P	109	Aluminio	8424450241875
68330200220501	AE44822-KAL109	48	2200K	Programable	K	109	Aluminio	8424450241882
68330200220601	AE44822-T2AL109	48	2200K	Programable	T2	109	Aluminio	8424450241899
68330200220701	AE44822-MEAL109	48	2200K	Programable	ME	109	Aluminio	8424450241905
68330200220801	AE44822-T3AL109	48	2200K	Programable	T3	109	Aluminio	8424450241912
68330200220901	AE44822-APZAL109	48	2200K	Programable	APZ	109	Aluminio	8424450241929
68330200221301	AE44822-SCLAL109	48	2200K	Programable	SCL	109	Aluminio	8424450241936
68330200300101	AE44830-PAL109	48	3000K	Programable	P	109	Aluminio	8424450242018
68330200300501	AE44830-KAL109	48	3000K	Programable	K	109	Aluminio	8424450242025
68330200300601	AE44830-T2AL109	48	3000K	Programable	T2	109	Aluminio	8424450242032
68330200300701	AE44830-MEAL109	48	3000K	Programable	ME	109	Aluminio	8424450242049
68330200300801	AE44830-T3AL109	48	3000K	Programable	T3	109	Aluminio	8424450242056
68330200300901	AE44830-APZAL109	48	3000K	Programable	APZ	109	Aluminio	8424450242063
68330200301301	AE44830-SCLAL109	48	3000K	Programable	SCL	109	Aluminio	8424450242070
68330200400101	AE44840-PAL109	48	4000K	Programable	P	109	Aluminio	8424450242087
68330200400501	AE44840-KAL109	48	4000K	Programable	K	109	Aluminio	8424450242094
68330200400601	AE44840-T2AL109	48	4000K	Programable	T2	109	Aluminio	8424450242100
68330200400701	AE44840-MEAL109	48	4000K	Programable	ME	109	Aluminio	8424450242117
68330200400801	AE44840-T3AL109	48	4000K	Programable	T3	109	Aluminio	8424450242124
68330200400901	AE44840-APZAL109	48	4000K	Programable	APZ	109	Aluminio	8424450242131
68330200401301	AE44840-SCLAL109	48	4000K	Programable	SCL	109	Aluminio	8424450242148

ALUMBRADO EXTERIOR INTERURBANO

ATMOSLED



REF. PEDIDO	REF. LÓGICA	Nº LEDs		CONTROL	TIPO DE ÓPTICA	POTENCIA (W)		EAN13
Serie E-4								
68530200180101	AE7218-PAL148	72	PC Ámbar	Programable	P	148	Aluminio	8424450257654
68530200180501	AE7218-KAL148	72	PC Ámbar	Programable	K	148	Aluminio	8424450257661
68530200180601	AE7218-T2AL148	72	PC Ámbar	Programable	T2	148	Aluminio	8424450257678
68530200180701	AE7218-MEAL148	72	PC Ámbar	Programable	ME	148	Aluminio	8424450257685
68530200180801	AE7218-T3AL148	72	PC Ámbar	Programable	T3	148	Aluminio	8424450257692
68530200180901	AE7218-APZAL148	72	PC Ámbar	Programable	APZ	148	Aluminio	8424450257708
68530200181301	AE7218-SCLAL148	72	PC Ámbar	Programable	SCL	148	Aluminio	8424450257715
68530200220101	AE7222-PAL148	72	2200K	Programable	P	148	Aluminio	8424450253731
68530200220501	AE7222-KAL148	72	2200K	Programable	K	148	Aluminio	8424450253748
68530200220601	AE7222-T2AL148	72	2200K	Programable	T2	148	Aluminio	8424450253755
68530200220701	AE7222-MEAL148	72	2200K	Programable	ME	148	Aluminio	8424450253762
68530200220801	AE7222-T3AL148	72	2200K	Programable	T3	148	Aluminio	8424450253779
68530200220901	AE7222-APZAL148	72	2200K	Programable	APZ	148	Aluminio	8424450253786
68530200221301	AE7222-SCLAL148	72	2200K	Programable	SCL	148	Aluminio	8424450253793
68530200300101	AE7230-PAL148	72	3000K	Programable	P	148	Aluminio	8424450253878
68530200300501	AE7230-KAL148	72	3000K	Programable	K	148	Aluminio	8424450253885
68530200300601	AE7230-T2AL148	72	3000K	Programable	T2	148	Aluminio	8424450253892
68530200300701	AE7230-MEAL148	72	3000K	Programable	ME	148	Aluminio	8424450253908
68530200300801	AE7230-T3AL148	72	3000K	Programable	T3	148	Aluminio	8424450253915
68530200300901	AE7230-APZAL148	72	3000K	Programable	APZ	148	Aluminio	8424450253922
68530200301301	AE7230-SCLAL148	72	3000K	Programable	SCL	148	Aluminio	8424450253939
68530200400101	AE7240-PAL148	72	4000K	Programable	P	148	Aluminio	8424450253038
68530200400501	AE7240-KAL148	72	4000K	Programable	K	148	Aluminio	8424450253946
68530200400601	AE7240-T2AL148	72	4000K	Programable	T2	148	Aluminio	8424450253953
68530200400701	AE7240-MEAL148	72	4000K	Programable	ME	148	Aluminio	8424450253960
68530200400801	AE7240-T3AL148	72	4000K	Programable	T3	148	Aluminio	8424450253977
68530200400901	AE7240-APZAL148	72	4000K	Programable	APZ	148	Aluminio	8424450253984
68530200401301	AE7240-SCLAL148	72	4000K	Programable	SCL	148	Aluminio	8424450253991

ATMOSLED



REF. PEDIDO	REF. LÓGICA	Nº LEDs	💡	CONTROL	TIPO DE ÓPTICA	POTENCIA (W)	🔩	EAN13
Serie N								
68050000180101	AN1218-PAL39	12	PC Ámbar	Telegestión	P	39	Aluminio	8424450265116
68050000180501	AN1218-KAL39	12	PC Ámbar	Telegestión	K	39	Aluminio	8424450265123
68050000180601	AN1218-T2AL39	12	PC Ámbar	Telegestión	T2	39	Aluminio	8424450265130
68050000180701	AN1218-MEAL39	12	PC Ámbar	Telegestión	ME	39	Aluminio	8424450265147
68050000180801	AN1218-T3AL39	12	PC Ámbar	Telegestión	T3	39	Aluminio	8424450265154
68050000180901	AN1218-APZAL39	12	PC Ámbar	Telegestión	APZ	39	Aluminio	8424450265161
68050000181301	AN1218-SCLAL39	12	PC Ámbar	Telegestión	SCL	39	Aluminio	8424450265178
68050000220101	AN1222-PAL39	12	2200K	Telegestión	P	39	Aluminio	8424450234969
68050000220501	AN1222-KAL39	12	2200K	Telegestión	K	39	Aluminio	8424450232019
68050000220601	AN1222-T2AL39	12	2200K	Telegestión	T2	39	Aluminio	8424450232071
68050000220701	AN1222-MEAL39	12	2200K	Telegestión	ME	39	Aluminio	8424450232149
68050000220801	AN1222-T3AL39	12	2200K	Telegestión	T3	39	Aluminio	8424450232088
68050000220901	AN1222-APZAL39	12	2200K	Telegestión	APZ	39	Aluminio	8424450232095
68050000221301	AN1222-SCLAL39	12	2200K	Telegestión	SCL	39	Aluminio	8424450265185
68050000300101	AN1230-PAL39	12	3000K	Telegestión	P	39	Aluminio	8424450232101
68050000300501	AN1230-KAL39	12	3000K	Telegestión	K	39	Aluminio	8424450209950
68050000300601	AN1230-T2AL39	12	3000K	Telegestión	T2	39	Aluminio	8424450232118
68050000300701	AN1230-MEAL39	12	3000K	Telegestión	ME	39	Aluminio	8424450232125
68050000300801	AN1230-T3AL39	12	3000K	Telegestión	T3	39	Aluminio	8424450232132
68050000300901	AN1230-APZAL39	12	3000K	Telegestión	APZ	39	Aluminio	8424450232156
68050000301301	AN1230-SCLAL39	12	3000K	Telegestión	SCL	39	Aluminio	8424450265192
68050000400101	AN1240-PAL39	12	4000K	Telegestión	P	39	Aluminio	8424450232163
68050000400501	AN1240-KAL39	12	4000K	Telegestión	K	39	Aluminio	8424450203569
68050000400601	AN1240-T2AL39	12	4000K	Telegestión	T2	39	Aluminio	8424450232170
68050000400701	AN1240-MEAL39	12	4000K	Telegestión	ME	39	Aluminio	8424450232187
68050000400801	AN1240-T3AL39	12	4000K	Telegestión	T3	39	Aluminio	8424450232194
68050000400901	AN1240-APZAL39	12	4000K	Telegestión	APZ	39	Aluminio	8424450232200
68050000401301	AN1240-SCLAL39	12	4000K	Telegestión	SCL	39	Aluminio	8424450265208
68150000180101	AN2418-PAL58	24	PC Ámbar	Telegestión	P	58	Aluminio	8424450265215
68150000180501	AN2418-KAL58	24	PC Ámbar	Telegestión	K	58	Aluminio	8424450265222
68150000180601	AN2418-T2AL58	24	PC Ámbar	Telegestión	T2	58	Aluminio	8424450265239
68150000180701	AN2418-MEAL58	24	PC Ámbar	Telegestión	ME	58	Aluminio	8424450265246
68150000180801	AN2418-T3AL58	24	PC Ámbar	Telegestión	T3	58	Aluminio	8424450265253
68150000180901	AN2418-APZAL58	24	PC Ámbar	Telegestión	APZ	58	Aluminio	8424450265260
68150000181301	AN2418-SCLAL58	24	PC Ámbar	Telegestión	SCL	58	Aluminio	8424450265277
68150000220101	AN2422-PAL58	24	2200K	Telegestión	P	58	Aluminio	8424450234839
68150000220501	AN2422-KAL58	24	2200K	Telegestión	K	58	Aluminio	8424450234822
68150000220601	AN2422-T2AL58	24	2200K	Telegestión	T2	58	Aluminio	8424450234815
68150000220701	AN2422-MEAL58	24	2200K	Telegestión	ME	58	Aluminio	8424450234808
68150000220801	AN2422-T3AL58	24	2200K	Telegestión	T3	58	Aluminio	8424450234792
68150000220901	AN2422-APZAL58	24	2200K	Telegestión	APZ	58	Aluminio	8424450234785
68150000221301	AN2422-SCLAL58	24	2200K	Telegestión	SCL	58	Aluminio	8424450265284
68150000300101	AN2430-PAL58	24	3000K	Telegestión	P	58	Aluminio	8424450233160
68150000300501	AN2430-KAL58	24	3000K	Telegestión	K	58	Aluminio	8424450209967
68150000300601	AN2430-T2AL58	24	3000K	Telegestión	T2	58	Aluminio	8424450234754
68150000300701	AN2430-MEAL58	24	3000K	Telegestión	ME	58	Aluminio	8424450234747
68150000300801	AN2430-T3AL58	24	3000K	Telegestión	T3	58	Aluminio	8424450234730
68150000300901	AN2430-APZAL58	24	3000K	Telegestión	APZ	58	Aluminio	8424450234723
68150000301301	AN2430-SCLAL58	24	3000K	Telegestión	SCL	58	Aluminio	8424450265291
68150000400101	AN2440-PAL58	24	4000K	Telegestión	P	58	Aluminio	8424450234716
68150000400501	AN2440-KAL58	24	4000K	Telegestión	K	58	Aluminio	8424450203552
68150000400601	AN2440-T2AL58	24	4000K	Telegestión	T2	58	Aluminio	8424450234709
68150000400701	AN2440-MEAL58	24	4000K	Telegestión	ME	58	Aluminio	8424450234693
68150000400801	AN2440-T3AL58	24	4000K	Telegestión	T3	58	Aluminio	8424450234686
68150000400901	AN2440-APZAL58	24	4000K	Telegestión	APZ	58	Aluminio	8424450234679
68150000401301	AN2440-SCLAL58	24	4000K	Telegestión	SCL	58	Aluminio	8424450265307

ALUMBRADO EXTERIOR INTERURBANO



ATMOSLED



REF. PEDIDO	REF. LÓGICA	Nº LEDs		CONTROL	TIPO DE ÓPTICA	POTENCIA (W)		EAN13
Serie N								
68250000180101	AN3618-PAL78	36	PC Ámbar	Telegestión	P	78	Aluminio	8424450265321
68250000180501	AN3618-KAL78	36	PC Ámbar	Telegestión	K	78	Aluminio	8424450265338
68250000180601	AN3618-T2AL78	36	PC Ámbar	Telegestión	T2	78	Aluminio	8424450265345
68250000180701	AN3618-MEAL78	36	PC Ámbar	Telegestión	ME	78	Aluminio	8424450265352
68250000180801	AN3618-T3AL78	36	PC Ámbar	Telegestión	T3	78	Aluminio	8424450265369
68250000180901	AN3618-APZAL78	36	PC Ámbar	Telegestión	APZ	78	Aluminio	8424450265376
68250000181301	AN3618-SCLAL78	36	PC Ámbar	Telegestión	SCL	78	Aluminio	8424450265383
68250000220101	AN3622-PAL78	36	2200K	Telegestión	P	78	Aluminio	8424450234594
68250000220501	AN3622-KAL78	36	2200K	Telegestión	K	78	Aluminio	8424450234587
68250000220601	AN3622-T2AL78	36	2200K	Telegestión	T2	78	Aluminio	8424450234570
68250000220701	AN3622-MEAL78	36	2200K	Telegestión	ME	78	Aluminio	8424450234563
68250000220801	AN3622-T3AL78	36	2200K	Telegestión	T3	78	Aluminio	8424450233146
68250000220901	AN3622-APZAL78	36	2200K	Telegestión	APZ	78	Aluminio	8424450234532
68250000221301	AN3622-SCLAL78	36	2200K	Telegestión	SCL	78	Aluminio	8424450265390
68250000300101	AN3630-PAL78	36	3000K	Telegestión	P	78	Aluminio	8424450234525
68250000300501	AN3630-KAL78	36	3000K	Telegestión	K	78	Aluminio	8424450234518
68250000300601	AN3630-T2AL78	36	3000K	Telegestión	T2	78	Aluminio	8424450234501
68250000300701	AN3630-MEAL78	36	3000K	Telegestión	ME	78	Aluminio	8424450234495
68250000300801	AN3630-T3AL78	36	3000K	Telegestión	T3	78	Aluminio	8424450234488
68250000300901	AN3630-APZAL78	36	3000K	Telegestión	APZ	78	Aluminio	8424450234471
68250000301301	AN3630-SCLAL78	36	3000K	Telegestión	SCL	78	Aluminio	8424450265406
68250000400101	AN3640-PAL78	36	4000K	Telegestión	P	78	Aluminio	8424450234464
68250000400501	AN3640-KAL78	36	4000K	Telegestión	K	78	Aluminio	8424450203545
68250000400601	AN3640-T2AL78	36	4000K	Telegestión	T2	78	Aluminio	8424450234457
68250000400701	AN3640-MEAL78	36	4000K	Telegestión	ME	78	Aluminio	8424450233139
68250000400801	AN3640-T3AL78	36	4000K	Telegestión	T3	78	Aluminio	8424450234426
68250000400901	AN3640-APZAL78	36	4000K	Telegestión	APZ	78	Aluminio	8424450234419
68250000401301	AN3640-SCLAL78	36	4000K	Telegestión	SCL	78	Aluminio	8424450265413
68350000180101	AN4818-PAL108	48	PC Ámbar	Telegestión	P	108	Aluminio	8424450265420
68350000180501	AN4818-KAL108	48	PC Ámbar	Telegestión	K	108	Aluminio	8424450265437
68350000180601	AN4818-T2AL108	48	PC Ámbar	Telegestión	T2	108	Aluminio	8424450265444
68350000180701	AN4818-MEAL108	48	PC Ámbar	Telegestión	ME	108	Aluminio	8424450265451
68350000180801	AN4818-T3AL108	48	PC Ámbar	Telegestión	T3	108	Aluminio	8424450265468
68350000180901	AN4818-APZAL108	48	PC Ámbar	Telegestión	APZ	108	Aluminio	8424450265475
68350000181301	AN4818-SCLAL108	48	PC Ámbar	Telegestión	SCL	108	Aluminio	8424450265482
68350000220101	AN4822-PAL108	48	2200K	Telegestión	P	108	Aluminio	8424450234341
68350000220501	AN4822-KAL108	48	2200K	Telegestión	K	108	Aluminio	8424450234310
68350000220601	AN4822-T2AL108	48	2200K	Telegestión	T2	108	Aluminio	8424450234297
68350000220701	AN4822-MEAL108	48	2200K	Telegestión	ME	108	Aluminio	8424450234280
68350000220801	AN4822-T3AL108	48	2200K	Telegestión	T3	108	Aluminio	8424450234273
68350000220901	AN4822-APZAL108	48	2200K	Telegestión	APZ	108	Aluminio	8424450234266
68350000221301	AN4822-SCLAL108	48	2200K	Telegestión	SCL	108	Aluminio	8424450265499
68350000300101	AN4830-PAL108	48	3000K	Telegestión	P	108	Aluminio	8424450234259
68350000300501	AN4830-KAL108	48	3000K	Telegestión	K	108	Aluminio	8424450209974
68350000300601	AN4830-T2AL108	48	3000K	Telegestión	T2	108	Aluminio	8424450234242
68350000300701	AN4830-MEAL108	48	3000K	Telegestión	ME	108	Aluminio	8424450234235
68350000300801	AN4830-T3AL108	48	3000K	Telegestión	T3	108	Aluminio	8424450233115
68350000300901	AN4830-APZAL108	48	3000K	Telegestión	APZ	108	Aluminio	8424450234204
68350000301301	AN4830-SCLAL108	48	3000K	Telegestión	SCL	108	Aluminio	8424450265505
68350000400101	AN4840-PAL108	48	4000K	Telegestión	P	108	Aluminio	8424450234198
68350000400501	AN4840-KAL108	48	4000K	Telegestión	K	108	Aluminio	8424450203538
68350000400601	AN4840-T2AL108	48	4000K	Telegestión	T2	108	Aluminio	8424450234181
68350000400701	AN4840-MEAL108	48	4000K	Telegestión	ME	108	Aluminio	8424450234174
68350000400801	AN4840-T3AL108	48	4000K	Telegestión	T3	108	Aluminio	8424450234167
68350000400901	AN4840-APZAL108	48	4000K	Telegestión	APZ	108	Aluminio	8424450234150
68350000401301	AN4840-SCLAL108	48	4000K	Telegestión	SCL	108	Aluminio	8424450265512

ATMOSLED



REF. PEDIDO	REF. LÓGICA	Nº LEDs		CONTROL	TIPO DE ÓPTICA	POTENCIA (W)		EAN13
Serie Z								
68090200180101	AZ1218-PAL40	12	PC Ámbar	Telegestión	P	40	Aluminio	8424450257722
68090200180501	AZ1218-KAL40	12	PC Ámbar	Telegestión	K	40	Aluminio	8424450257739
68090200180601	AZ1218-T2AL40	12	PC Ámbar	Telegestión	T2	40	Aluminio	8424450257746
68090200180701	AZ1218-MEAL40	12	PC Ámbar	Telegestión	ME	40	Aluminio	8424450257753
68090200180801	AZ1218-T3AL40	12	PC Ámbar	Telegestión	T3	40	Aluminio	8424450257760
68090200180901	AZ1218-APZAL40	12	PC Ámbar	Telegestión	APZ	40	Aluminio	8424450257777
68090200181301	AZ1218-SCLAL40	12	PC Ámbar	Telegestión	SCL	40	Aluminio	8424450257784
68090200220101	AZ1222-PAL40	12	2200K	Telegestión	P	40	Aluminio	8424450220092
68090200220501	AZ1222-KAL40	12	2200K	Telegestión	K	40	Aluminio	8424450220108
68090200220601	AZ1222-T2AL40	12	2200K	Telegestión	T2	40	Aluminio	8424450220115
68090200220701	AZ1222-MEAL40	12	2200K	Telegestión	ME	40	Aluminio	8424450220122
68090200220801	AZ1222-T3AL40	12	2200K	Telegestión	T3	40	Aluminio	8424450220139
68090200220901	AZ1222-APZAL40	12	2200K	Telegestión	APZ	40	Aluminio	8424450220146
68090200221301	AZ1222-SCLAL40	12	2200K	Telegestión	SCL	40	Aluminio	8424450257791
68090200300101	AZ1230-PAL40	12	3000K	Telegestión	P	40	Aluminio	8424450220153
68090200300501	AZ1230-KAL40	12	3000K	Telegestión	K	40	Aluminio	8424450220160
68090200300601	AZ1230-T2AL40	12	3000K	Telegestión	T2	40	Aluminio	8424450220177
68090200300701	AZ1230-MEAL40	12	3000K	Telegestión	ME	40	Aluminio	8424450220184
68090200300801	AZ1230-T3AL40	12	3000K	Telegestión	T3	40	Aluminio	8424450220191
68090200300901	AZ1230-APZAL40	12	3000K	Telegestión	APZ	40	Aluminio	8424450220207
68090200301301	AZ1230-SCLAL40	12	3000K	Telegestión	SCL	40	Aluminio	8424450257807
68090200400101	AZ1240-PAL40	12	4000K	Telegestión	P	40	Aluminio	8424450220214
68090200400501	AZ1240-KAL40	12	4000K	Telegestión	K	40	Aluminio	8424450214640
68090200400601	AZ1240-T2AL40	12	4000K	Telegestión	T2	40	Aluminio	8424450234846
68090200400701	AZ1240-MEAL40	12	4000K	Telegestión	ME	40	Aluminio	8424450220221
68090200400801	AZ1240-T3AL40	12	4000K	Telegestión	T3	40	Aluminio	8424450220238
68090200400901	AZ1240-APZAL40	12	4000K	Telegestión	APZ	40	Aluminio	8424450220245
68090200401301	AZ1240-SCLAL40	12	4000K	Telegestión	SCL	40	Aluminio	8424450257814
68190200180101	AZ2418-PAL60	24	PC Ámbar	Telegestión	P	60	Aluminio	8424450257821
68190200180501	AZ2418-KAL60	24	PC Ámbar	Telegestión	K	60	Aluminio	8424450257838
68190200180601	AZ2418-T2AL60	24	PC Ámbar	Telegestión	T2	60	Aluminio	8424450257845
68190200180701	AZ2418-MEAL60	24	PC Ámbar	Telegestión	ME	60	Aluminio	8424450257852
68190200180801	AZ2418-T3AL60	24	PC Ámbar	Telegestión	T3	60	Aluminio	8424450257869
68190200180901	AZ2418-APZAL60	24	PC Ámbar	Telegestión	APZ	60	Aluminio	8424450257876
68190200181301	AZ2418-SCLAL60	24	PC Ámbar	Telegestión	SCL	60	Aluminio	8424450257883
68190200220101	AZ2422-PAL60	24	2200K	Telegestión	P	60	Aluminio	8424450220313
68190200220501	AZ2422-KAL60	24	2200K	Telegestión	K	60	Aluminio	8424450220320
68190200220601	AZ2422-T2AL60	24	2200K	Telegestión	T2	60	Aluminio	8424450220337
68190200220701	AZ2422-MEAL60	24	2200K	Telegestión	ME	60	Aluminio	8424450220344
68190200220801	AZ2422-T3AL60	24	2200K	Telegestión	T3	60	Aluminio	8424450220351
68190200220901	AZ2422-APZAL60	24	2200K	Telegestión	APZ	60	Aluminio	8424450220368
68190200221301	AZ2422-SCLAL60	24	2200K	Telegestión	SCL	60	Aluminio	8424450257890
68190200300101	AZ2430-PAL60	24	3000K	Telegestión	P	60	Aluminio	8424450220375
68190200300501	AZ2430-KAL60	24	3000K	Telegestión	K	60	Aluminio	8424450220382
68190200300601	AZ2430-T2AL60	24	3000K	Telegestión	T2	60	Aluminio	8424450220399
68190200300701	AZ2430-MEAL60	24	3000K	Telegestión	ME	60	Aluminio	8424450220405
68190200300801	AZ2430-T3AL60	24	3000K	Telegestión	T3	60	Aluminio	8424450220412
68190200300901	AZ2430-APZAL60	24	3000K	Telegestión	APZ	60	Aluminio	8424450220429
68190200301301	AZ2430-SCLAL60	24	3000K	Telegestión	SCL	60	Aluminio	8424450257906
68190200400101	AZ2440-PAL60	24	4000K	Telegestión	P	60	Aluminio	8424450220436
68190200400501	AZ2440-KAL60	24	4000K	Telegestión	K	60	Aluminio	8424450214657
68190200400601	AZ2440-T2AL60	24	4000K	Telegestión	T2	60	Aluminio	8424450220443
68190200400701	AZ2440-MEAL60	24	4000K	Telegestión	ME	60	Aluminio	8424450220450
68190200400801	AZ2440-T3AL60	24	4000K	Telegestión	T3	60	Aluminio	8424450220467
68190200400901	AZ2440-APZAL60	24	4000K	Telegestión	APZ	60	Aluminio	8424450220474
68190200401301	AZ2440-SCLAL60	24	4000K	Telegestión	SCL	60	Aluminio	8424450257913

ALUMBRADO EXTERIOR INTERURBANO



ATMOSLED



REF. PEDIDO	REF. LÓGICA	Nº LEDs		CONTROL	TIPO DE ÓPTICA	POTENCIA (W)		EAN13
Serie Z								
68290200180101	AZ3618-PAL77	36	PC Ámbar	Telegestión	P	77	Aluminio	8424450257920
68290200180501	AZ3618-KAL77	36	PC Ámbar	Telegestión	K	77	Aluminio	8424450257937
68290200180601	AZ3618-T2AL77	36	PC Ámbar	Telegestión	T2	77	Aluminio	8424450257944
68290200180701	AZ3618-MEAL77	36	PC Ámbar	Telegestión	ME	77	Aluminio	8424450257951
68290200180801	AZ3618-T3AL77	36	PC Ámbar	Telegestión	T3	77	Aluminio	8424450257968
68290200180901	AZ3618-APZAL77	36	PC Ámbar	Telegestión	APZ	77	Aluminio	8424450257975
68290200181301	AZ3618-SCLAL77	36	PC Ámbar	Telegestión	SCL	77	Aluminio	8424450257982
68290200220101	AZ3622-PAL77	36	2200K	Telegestión	P	77	Aluminio	8424450220542
68290200220501	AZ3622-KAL77	36	2200K	Telegestión	K	77	Aluminio	8424450220559
68290200220601	AZ3622-T2AL77	36	2200K	Telegestión	T2	77	Aluminio	8424450220566
68290200220701	AZ3622-MEAL77	36	2200K	Telegestión	ME	77	Aluminio	8424450220573
68290200220801	AZ3622-T3AL77	36	2200K	Telegestión	T3	77	Aluminio	8424450220580
68290200220901	AZ3622-APZAL77	36	2200K	Telegestión	APZ	77	Aluminio	8424450220597
68290200221301	AZ3622-SCLAL77	36	2200K	Telegestión	SCL	77	Aluminio	8424450257999
68290200300101	AZ3630-PAL77	36	3000K	Telegestión	P	77	Aluminio	8424450220603
68290200300501	AZ3630-KAL77	36	3000K	Telegestión	K	77	Aluminio	8424450220610
68290200300601	AZ3630-T2AL77	36	3000K	Telegestión	T2	77	Aluminio	8424450220627
68290200300701	AZ3630-MEAL77	36	3000K	Telegestión	ME	77	Aluminio	8424450220634
68290200300801	AZ3630-T3AL77	36	3000K	Telegestión	T3	77	Aluminio	8424450220641
68290200300901	AZ3630-APZAL77	36	3000K	Telegestión	APZ	77	Aluminio	8424450220658
68290200301301	AZ3630-SCLAL77	36	3000K	Telegestión	SCL	77	Aluminio	8424450258002
68290200400101	AZ3640-PAL77	36	4000K	Telegestión	P	77	Aluminio	8424450220665
68290200400501	AZ3640-KAL77	36	4000K	Telegestión	K	77	Aluminio	8424450214664
68290200400601	AZ3640-T2AL77	36	4000K	Telegestión	T2	77	Aluminio	8424450220672
68290200400701	AZ3640-MEAL77	36	4000K	Telegestión	ME	77	Aluminio	8424450220689
68290200400801	AZ3640-T3AL77	36	4000K	Telegestión	T3	77	Aluminio	8424450220696
68290200400901	AZ3640-APZAL77	36	4000K	Telegestión	APZ	77	Aluminio	8424450220702
68290200401301	AZ3640-SCLAL77	36	4000K	Telegestión	SCL	77	Aluminio	8424450258019
68390200180101	AZ4818-PAL109	48	PC Ámbar	Telegestión	P	109	Aluminio	8424450258026
68390200180501	AZ4818-KAL109	48	PC Ámbar	Telegestión	K	109	Aluminio	8424450258033
68390200180601	AZ4818-T2AL109	48	PC Ámbar	Telegestión	T2	109	Aluminio	8424450258040
68390200180701	AZ4818-MEAL109	48	PC Ámbar	Telegestión	ME	109	Aluminio	8424450258057
68390200180801	AZ4818-T3AL109	48	PC Ámbar	Telegestión	T3	109	Aluminio	8424450258064
68390200180901	AZ4818-APZAL109	48	PC Ámbar	Telegestión	APZ	109	Aluminio	8424450258071
68390200181301	AZ4818-SCLAL109	48	PC Ámbar	Telegestión	SCL	109	Aluminio	8424450258088
68390200220101	AZ4822-PAL109	48	2200K	Telegestión	P	109	Aluminio	8424450220771
68390200220501	AZ4822-KAL109	48	2200K	Telegestión	K	109	Aluminio	8424450220788
68390200220601	AZ4822-T2AL109	48	2200K	Telegestión	T2	109	Aluminio	8424450220795
68390200220701	AZ4822-MEAL109	48	2200K	Telegestión	ME	109	Aluminio	8424450220801
68390200220801	AZ4822-T3AL109	48	2200K	Telegestión	T3	109	Aluminio	8424450220818
68390200220901	AZ4822-APZAL109	48	2200K	Telegestión	APZ	109	Aluminio	8424450220825
68390200221301	AZ4822-SCLAL109	48	2200K	Telegestión	SCL	109	Aluminio	8424450258095
68390200300101	AZ4830-PAL109	48	3000K	Telegestión	P	109	Aluminio	8424450220832
68390200300501	AZ4830-KAL109	48	3000K	Telegestión	K	109	Aluminio	8424450220849
68390200300601	AZ4830-T2AL109	48	3000K	Telegestión	T2	109	Aluminio	8424450220856
68390200300701	AZ4830-MEAL109	48	3000K	Telegestión	ME	109	Aluminio	8424450220863
68390200300801	AZ4830-T3AL109	48	3000K	Telegestión	T3	109	Aluminio	8424450220870
68390200300901	AZ4830-APZAL109	48	3000K	Telegestión	APZ	109	Aluminio	8424450220887
68390200301301	AZ4830-SCLAL109	48	3000K	Telegestión	SCL	109	Aluminio	8424450258101
68390200400101	AZ4840-PAL109	48	4000K	Telegestión	P	109	Aluminio	8424450220894
68390200400501	AZ4840-KAL109	48	4000K	Telegestión	K	109	Aluminio	8424450214671
68390200400601	AZ4840-T2AL109	48	4000K	Telegestión	T2	109	Aluminio	8424450220900
68390200400701	AZ4840-MEAL109	48	4000K	Telegestión	ME	109	Aluminio	8424450220917
68390200400801	AZ4840-T3AL109	48	4000K	Telegestión	T3	109	Aluminio	8424450220924
68390200400901	AZ4840-APZAL109	48	4000K	Telegestión	APZ	109	Aluminio	8424450220931
68390200401301	AZ4840-SCLAL109	48	4000K	Telegestión	SCL	109	Aluminio	8424450258118



ATMOSLED

REF. PEDIDO	REF. LÓGICA	Nº LEDs		CONTROL	TIPO DE ÓPTICA	POTENCIA (W)		EAN13
Serie Z								
68590200180101	AZ7218-PAL148	72	PC Ámbar	Telegestión	P	148	Aluminio	8424450258125
68590200180501	AZ7218-KAL148	72	PC Ámbar	Telegestión	K	148	Aluminio	8424450258132
68590200180601	AZ7218-T2AL148	72	PC Ámbar	Telegestión	T2	148	Aluminio	8424450258149
68590200180701	AZ7218-MEAL148	72	PC Ámbar	Telegestión	ME	148	Aluminio	8424450258156
68590200180801	AZ7218-T3AL148	72	PC Ámbar	Telegestión	T3	148	Aluminio	8424450258163
68590200180901	AZ7218-APZAL148	72	PC Ámbar	Telegestión	APZ	148	Aluminio	8424450258170
68590200181301	AZ7218-SCLAL148	72	PC Ámbar	Telegestión	SCL	148	Aluminio	8424450258187
68590200220101	AZ7222-PAL148	72	2200K	Telegestión	P	148	Aluminio	8424450254004
68590200220501	AZ7222-KAL148	72	2200K	Telegestión	K	148	Aluminio	8424450254011
68590200220601	AZ7222-T2AL148	72	2200K	Telegestión	T2	148	Aluminio	8424450254028
68590200220701	AZ7222-MEAL148	72	2200K	Telegestión	ME	148	Aluminio	8424450254035
68590200220801	AZ7222-T3AL148	72	2200K	Telegestión	T3	148	Aluminio	8424450254042
68590200220901	AZ7222-APZAL148	72	2200K	Telegestión	APZ	148	Aluminio	8424450254059
68590200221301	AZ7222-SCLAL148	72	2200K	Telegestión	SCL	148	Aluminio	8424450254066
68590200300101	AZ7230-PAL148	72	3000K	Telegestión	P	148	Aluminio	8424450254141
68590200300501	AZ7230-KAL148	72	3000K	Telegestión	K	148	Aluminio	8424450254158
68590200300601	AZ7230-T2AL148	72	3000K	Telegestión	T2	148	Aluminio	8424450254165
68590200300701	AZ7230-MEAL148	72	3000K	Telegestión	ME	148	Aluminio	8424450254172
68590200300801	AZ7230-T3AL148	72	3000K	Telegestión	T3	148	Aluminio	8424450254189
68590200300901	AZ7230-APZAL148	72	3000K	Telegestión	APZ	148	Aluminio	8424450254196
68590200301301	AZ7230-SCLAL148	72	3000K	Telegestión	SCL	148	Aluminio	8424450254202
68590200400101	AZ7240-PAL148	72	4000K	Telegestión	P	148	Aluminio	8424450246634
68590200400501	AZ7240-KAL148	72	4000K	Telegestión	K	148	Aluminio	8424450254219
68590200400601	AZ7240-T2AL148	72	4000K	Telegestión	T2	148	Aluminio	8424450254226
68590200400701	AZ7240-MEAL148	72	4000K	Telegestión	ME	148	Aluminio	8424450254233
68590200400801	AZ7240-T3AL148	72	4000K	Telegestión	T3	148	Aluminio	8424450254240
68590200400901	AZ7240-APZAL148	72	4000K	Telegestión	APZ	148	Aluminio	8424450254257
68590200401301	AZ7240-SCLAL148	72	4000K	Telegestión	SCL	148	Aluminio	8424450254264

ALUMBRADO EXTERIOR INTERURBANO

ACCESORIOS



REF. PEDIDO	REF. LÓGICA	DESCRIPCIÓN	EAN13
69000201	ASH8AL	Soporte de Brazo Horizontal para AtmosLED, Aluminio	8424450191880
69000401	ASV8AL	Soporte de Brazo Vertical para AtmosLED, Aluminio	8424450191903
69000601	ASD8AL	Soporte de Brazo Doble para AtmosLED, Aluminio	8424450199787
69000801	ASW8AL	Soporte de Pared para AtmosLED, Acero Galvanizado	8424450199817
690010	AP40	Adaptador de Báculo Ø30-40mm para CIES y AtmosLED	8424450231913
690011	ATAP76	Adaptador de Báculo Ø76mm para AtmosLED	8424450231920
690012	AAP42	Adaptador de Báculo Ø42mm para CIES y AtmosLED	8424450261262
690020	ASW	Soporte de Pared para CIES	8424450251355
690604	POLE4AL	Columna de fibra de vidrio para CIES y AtmosLED. 4m	8424450251812
690605	POLE5AL	Columna de fibra de vidrio para CIES y AtmosLED. 5m	8424450251829
690606	POLE6AL	Columna de fibra de vidrio para CIES y AtmosLED. 6m	8424450251836
690607	POLE7AL	Columna de fibra de vidrio para CIES y AtmosLED. 7m	8424450251843
690608	POLE8AL	Columna de fibra de vidrio para CIES y AtmosLED. 8m	8424450251850
690609	POLE9AL	Columna de fibra de vidrio para CIES y AtmosLED. 9m	8424450251867
691001	ANC	Tapa conector NEMA para AtmosLED Serie N	8424450206263



69000601



69000801



Montaje horizontal

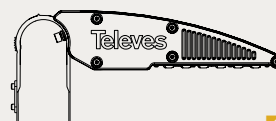

Montaje vertical



Montaje pared

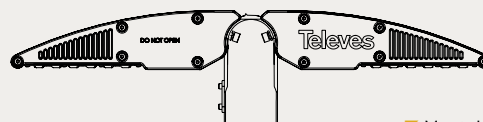

Montaje doble

URBAN ALAMEDA





REF. PEDIDO	REF. LÓGICA	Nº LEDs		CONTROL	TIPO DE ÓPTICA	POTENCIA (W)		EAN13
Serie E								
63170300180202	UA2418-SPBL53	24	PC Ámbar	ON/OFF	SP	53	Negro	8424450259443
63170300181102	UA2418-D90BL53	24	PC Ámbar	ON/OFF	D90	53	Negro	8424450259450
63170300220202	UA2422-SPBL53	24	2200K	ON/OFF	SP	53	Negro	8424450215883
63170300221102	UA2422-D90BL53	24	2200K	ON/OFF	D90	53	Negro	8424450230220
63170300300202	UA2430-SPBL53	24	3000K	ON/OFF	SP	53	Negro	8424450215906
63170300301102	UA2430-D90BL53	24	3000K	ON/OFF	D90	53	Negro	8424450230237
63170300400202	UA2440-SPBL53	24	4000K	ON/OFF	SP	53	Negro	8424450215920
63170300401102	UA2440-D90BL53	24	4000K	ON/OFF	D90	53	Negro	8424450221150
63170301180202	UA2418D-SPBL53	24	PC Ámbar	Dimming	SP	53	Negro	8424450259481
63170301181102	UA2418D-D90BL53	24	PC Ámbar	Dimming	D90	53	Negro	8424450259498
63170301220202	UA2422D-SPBL53	24	2200K	Dimming	SP	53	Negro	8424450213872
63170301221102	UA2422D-D90BL53	24	2200K	Dimming	D90	53	Negro	8424450230183
63170301300202	UA2430D-SPBL53	24	3000K	Dimming	SP	53	Negro	8424450215838
63170301301102	UA2430D-D90BL53	24	3000K	Dimming	D90	53	Negro	8424450230190
63170301400202	UA2440D-SPBL53	24	4000K	Dimming	SP	53	Negro	8424450209363
63170301401102	UA2440D-D90BL53	24	4000K	Dimming	D90	53	Negro	8424450230206
63171300180202	UA2418-SPBL39	24	PC Ámbar	ON/OFF	SP	39	Negro	8424450259429
63171300181102	UA2418-D90BL39	24	PC Ámbar	ON/OFF	D90	39	Negro	8424450259436
63171300220202	UA2422-SPBL39	24	2200K	ON/OFF	SP	39	Negro	8424450216187
63171300221102	UA2422-D90BL39	24	2200K	ON/OFF	D90	39	Negro	8424450230169
63171300300202	UA2430-SPBL39	24	3000K	ON/OFF	SP	39	Negro	8424450216200
63171300301102	UA2430-D90BL39	24	3000K	ON/OFF	D90	39	Negro	8424450219539
63171300400202	UA2440-SPBL39	24	4000K	ON/OFF	SP	39	Negro	8424450213056
63171300401102	UA2440-D90BL39	24	4000K	ON/OFF	D90	39	Negro	8424450212370
63171301180202	UA2418D-SPBL39	24	PC Ámbar	Dimming	SP	39	Negro	8424450259467
63171301181102	UA2418D-D90BL39	24	PC Ámbar	Dimming	D90	39	Negro	8424450259474
63171301220202	UA2422D-SPBL39	24	2200K	Dimming	SP	39	Negro	8424450235027
63171301221102	UA2422D-D90BL39	24	2200K	Dimming	D90	39	Negro	8424450230138
63171301300202	UA2430D-SPBL39	24	3000K	Dimming	SP	39	Negro	8424450216125
63171301301102	UA2430D-D90BL39	24	3000K	Dimming	D90	39	Negro	8424450230145
63171301400202	UA2440D-SPBL39	24	4000K	Dimming	SP	39	Negro	8424450216149
63171301401102	UA2440D-D90BL39	24	4000K	Dimming	D90	39	Negro	8424450222102

REF. PEDIDO	REF. LÓGICA	Nº LEDs		CONTROL	TIPO DE ÓPTICA	POTENCIA (W)		EAN13
Serie E-4								
66170300180202	UA42418-SPBL60	24	PC Ámbar	Programable	SP	60	Negro	8424450260111
66170300181102	UA42418-D90BL60	24	PC Ámbar	Programable	D90	60	Negro	8424450260128
66170300220202	UA42422-SPBL60	24	2200K	Programable	SP	60	Negro	8424450242957
66170300221102	UA42422-D90BL60	24	2200K	Programable	D90	60	Negro	8424450242964
66170300300202	UA42430-SPBL60	24	3000K	Programable	SP	60	Negro	8424450242995
66170300301102	UA42430-D90BL60	24	3000K	Programable	D90	60	Negro	8424450243008
66170300400202	UA42440-SPBL60	24	4000K	Programable	SP	60	Negro	8424450243015
66170300401102	UA42440-D90BL60	24	4000K	Programable	D90	60	Negro	8424450243022
66171300180202	UA42418-SPBL40	24	PC Ámbar	Programable	SP	40	Negro	8424450260098
66171300181102	UA42418-D90BL40	24	PC Ámbar	Programable	D90	40	Negro	8424450260104
66171300220202	UA42422-SPBL40	24	2200K	Programable	SP	40	Negro	8424450242872
66171300221102	UA42422-D90BL40	24	2200K	Programable	D90	40	Negro	8424450242889
66171300300202	UA42430-SPBL40	24	3000K	Programable	SP	40	Negro	8424450242919
66171300301102	UA42430-D90BL40	24	3000K	Programable	D90	40	Negro	8424450242926
66171300400202	UA42440-SPBL40	24	4000K	Programable	SP	40	Negro	8424450242933
66171300401102	UA42440-D90BL40	24	4000K	Programable	D90	40	Negro	8424450242940

ALUMBRADO EXTERIOR URBANO Y RESIDENCIAL

URBAN ALAMEDA





REF. PEDIDO	REF. LÓGICA	Nº LEDs		CONTROL	TIPO DE ÓPTICA	POTENCIA (W)		EAN13
Serie Z								
66190300180202	UAZ2418-SPBL60	24	PC Ámbar	Telegestión	SP	60	Negro	8424450260319
66190300181102	UAZ2418-D90BL60	24	PC Ámbar	Telegestión	D90	60	Negro	8424450260326
66190300220202	UAZ2422-SPBL60	24	2200K	Telegestión	SP	60	Negro	8424450221655
66190300221102	UAZ2422-D90BL60	24	2200K	Telegestión	D90	60	Negro	8424450221662
66190300300202	UAZ2430-SPBL60	24	3000K	Telegestión	SP	60	Negro	8424450221679
66190300301102	UAZ2430-D90BL60	24	3000K	Telegestión	D90	60	Negro	8424450221686
66190300400202	UAZ2440-SPBL60	24	4000K	Telegestión	SP	60	Negro	8424450221693
66190300401102	UAZ2440-D90BL60	24	4000K	Telegestión	D90	60	Negro	8424450214466
66191300180202	UAZ2418-SPBL40	24	PC Ámbar	Telegestión	SP	40	Negro	8424450260296
66191300181102	UAZ2418-D90BL40	24	PC Ámbar	Telegestión	D90	40	Negro	8424450260302
66191300220202	UAZ2422-SPBL40	24	2200K	Telegestión	SP	40	Negro	8424450221600
66191300221102	UAZ2422-D90BL40	24	2200K	Telegestión	D90	40	Negro	8424450221617
66191300300202	UAZ2430-SPBL40	24	3000K	Telegestión	SP	40	Negro	8424450221624
66191300301102	UAZ2430-D90BL40	24	3000K	Telegestión	D90	40	Negro	8424450221631
66191300400202	UAZ2440-SPBL40	24	4000K	Telegestión	SP	40	Negro	8424450221648
66191300401102	UAZ2440-D90BL40	24	4000K	Telegestión	D90	40	Negro	8424450214473



 URBAN ALAMEDA

URBAN MAIA



REF. PEDIDO	REF. LÓGICA	Nº LEDs		CONTROL	TIPO DE ÓPTICA	POTENCIA (W)		EAN13
Serie E								
63071400180102	UM1218-PBL39	12	PC Ámbar	ON/OFF	P	39	Negro	8424450259580
63071400180202	UM1218-SPBL39	12	PC Ámbar	ON/OFF	SP	39	Negro	8424450259597
63071400180502	UM1218-KBL39	12	PC Ámbar	ON/OFF	K	39	Negro	8424450259603
63071400180602	UM1218-T2BL39	12	PC Ámbar	ON/OFF	T2	39	Negro	8424450259610
63071400180702	UM1218-MEBL39	12	PC Ámbar	ON/OFF	ME	39	Negro	8424450259627
63071400180802	UM1218-T3BL39	12	PC Ámbar	ON/OFF	T3	39	Negro	8424450259634
63071400180902	UM1218-APZBL39	12	PC Ámbar	ON/OFF	APZ	39	Negro	8424450259641
63071400181302	UM1218-SCLBL39	12	PC Ámbar	ON/OFF	SCL	39	Negro	8424450259658
63071400220102	UM1222-PBL39	12	2200K	ON/OFF	P	39	Negro	8424450230268
63071400220202	UM1222-SPBL39	12	2200K	ON/OFF	SP	39	Negro	8424450215722
63071400220502	UM1222-KBL39	12	2200K	ON/OFF	K	39	Negro	8424450215739
63071400220602	UM1222-T2BL39	12	2200K	ON/OFF	T2	39	Negro	8424450230329
63071400220702	UM1222-MEBL39	12	2200K	ON/OFF	ME	39	Negro	8424450230336
63071400220802	UM1222-T3BL39	12	2200K	ON/OFF	T3	39	Negro	8424450230428
63071400220902	UM1222-APZBL39	12	2200K	ON/OFF	APZ	39	Negro	8424450230435
63071400221302	UM1222-SCLBL39	12	2200K	ON/OFF	SCL	39	Negro	8424450230831
63071400300102	UM1230-PBL39	12	3000K	ON/OFF	P	39	Negro	8424450230275
63071400300202	UM1230-SPBL39	12	3000K	ON/OFF	SP	39	Negro	8424450215746
63071400300502	UM1230-KBL39	12	3000K	ON/OFF	K	39	Negro	8424450215753
63071400300602	UM1230-T2BL39	12	3000K	ON/OFF	T2	39	Negro	8424450230343
63071400300702	UM1230-MEBL39	12	3000K	ON/OFF	ME	39	Negro	8424450230350
63071400300802	UM1230-T3BL39	12	3000K	ON/OFF	T3	39	Negro	8424450230442
63071400300902	UM1230-APZBL39	12	3000K	ON/OFF	APZ	39	Negro	8424450230459
63071400301302	UM1230-SCLBL39	12	3000K	ON/OFF	SCL	39	Negro	8424450230848
63071400400102	UM1240-PBL39	12	4000K	ON/OFF	P	39	Negro	8424450230282
63071400400202	UM1240-SPBL39	12	4000K	ON/OFF	SP	39	Negro	8424450215760
63071400400502	UM1240-KBL39	12	4000K	ON/OFF	K	39	Negro	8424450215777
63071400400602	UM1240-T2BL39	12	4000K	ON/OFF	T2	39	Negro	8424450230367
63071400400702	UM1240-MEBL39	12	4000K	ON/OFF	ME	39	Negro	8424450230374
63071400400802	UM1240-T3BL39	12	4000K	ON/OFF	T3	39	Negro	8424450230466
63071400400902	UM1240-APZBL39	12	4000K	ON/OFF	APZ	39	Negro	8424450230473
63071400401302	UM1240-SCLBL39	12	4000K	ON/OFF	SCL	39	Negro	8424450230855
63071401180102	UM1218D-PBL39	12	PC Ámbar	Dimming	P	39	Negro	8424450259504
63071401180202	UM1218D-SPBL39	12	PC Ámbar	Dimming	SP	39	Negro	8424450259511
63071401180502	UM1218D-KBL39	12	PC Ámbar	Dimming	K	39	Negro	8424450259528
63071401180602	UM1218D-T2BL39	12	PC Ámbar	Dimming	T2	39	Negro	8424450259535
63071401180702	UM1218D-MEBL39	12	PC Ámbar	Dimming	ME	39	Negro	8424450259542
63071401180802	UM1218D-T3BL39	12	PC Ámbar	Dimming	T3	39	Negro	8424450259559
63071401180902	UM1218D-APZBL39	12	PC Ámbar	Dimming	APZ	39	Negro	8424450259566
63071401181302	UM1218D-SCLBL39	12	PC Ámbar	Dimming	SCL	39	Negro	8424450259573
63071401220102	UM1222D-PBL39	12	2200K	Dimming	P	39	Negro	8424450222287
63071401220202	UM1222D-SPBL39	12	2200K	Dimming	SP	39	Negro	8424450215654
63071401220502	UM1222D-KBL39	12	2200K	Dimming	K	39	Negro	8424450215661
63071401220602	UM1222D-T2BL39	12	2200K	Dimming	T2	39	Negro	8424450222294
63071401220702	UM1222D-MEBL39	12	2200K	Dimming	ME	39	Negro	8424450222300
63071401220802	UM1222D-T3BL39	12	2200K	Dimming	T3	39	Negro	8424450222317
63071401220902	UM1222D-APZBL39	12	2200K	Dimming	APZ	39	Negro	8424450222324
63071401221302	UM1222D-SCLBL39	12	2200K	Dimming	SCL	39	Negro	8424450230794
63071401300102	UM1230D-PBL39	12	3000K	Dimming	P	39	Negro	8424450222171
63071401300202	UM1230D-SPBL39	12	3000K	Dimming	SP	39	Negro	8424450215678
63071401300502	UM1230D-KBL39	12	3000K	Dimming	K	39	Negro	8424450215685
63071401300602	UM1230D-T2BL39	12	3000K	Dimming	T2	39	Negro	8424450222188
63071401300702	UM1230D-MEBL39	12	3000K	Dimming	ME	39	Negro	8424450222195
63071401300802	UM1230D-T3BL39	12	3000K	Dimming	T3	39	Negro	8424450222201
63071401300902	UM1230D-APZBL39	12	3000K	Dimming	APZ	39	Negro	8424450222218
63071401301302	UM1230D-SCLBL39	12	3000K	Dimming	SCL	39	Negro	8424450230800

ALUMBRADO EXTERIOR URBANO Y RESIDENCIAL

URBAN MAIA



REF. PEDIDO	REF. LÓGICA	Nº LEDs		CONTROL	TIPO DE ÓPTICA	POTENCIA (W)		EAN13
Serie E								
63071401400102	UM1240D-PBL39	12	4000K	Dimming	P	39	Negro	8424450212622
63071401400202	UM1240D-SPBL39	12	4000K	Dimming	SP	39	Negro	8424450215692
63071401400502	UM1240D-KBL39	12	4000K	Dimming	K	39	Negro	8424450208250
63071401400602	UM1240D-T2BL39	12	4000K	Dimming	T2	39	Negro	8424450222232
63071401400702	UM1240D-MEBL39	12	4000K	Dimming	ME	39	Negro	8424450222249
63071401400802	UM1240D-T3BL39	12	4000K	Dimming	T3	39	Negro	8424450222256
63071401400902	UM1240D-APZBL39	12	4000K	Dimming	APZ	39	Negro	8424450222263
63071401401302	UM1240D-SCLBL39	12	4000K	Dimming	SCL	39	Negro	8424450230817
63170400180102	UM2418-PBL53	24	PC Ámbar	ON/OFF	P	53	Negro	8424450259740
63170400180202	UM2418-SPBL53	24	PC Ámbar	ON/OFF	SP	53	Negro	8424450259757
63170400180502	UM2418-KBL53	24	PC Ámbar	ON/OFF	K	53	Negro	8424450259764
63170400180602	UM2418-T2BL53	24	PC Ámbar	ON/OFF	T2	53	Negro	8424450259771
63170400180702	UM2418-MEBL53	24	PC Ámbar	ON/OFF	ME	53	Negro	8424450259788
63170400180802	UM2418-T3BL53	24	PC Ámbar	ON/OFF	T3	53	Negro	8424450259795
63170400180902	UM2418-APZBL53	24	PC Ámbar	ON/OFF	APZ	53	Negro	8424450259801
63170400181302	UM2418-SCLBL53	24	PC Ámbar	ON/OFF	SCL	53	Negro	8424450259818
63170400220102	UM2422-PBL53	24	2200K	ON/OFF	P	53	Negro	8424450230510
63170400220202	UM2422-SPBL53	24	2200K	ON/OFF	SP	53	Negro	8424450216033
63170400220502	UM2422-KBL53	24	2200K	ON/OFF	K	53	Negro	8424450216040
63170400220602	UM2422-T2BL53	24	2200K	ON/OFF	T2	53	Negro	8424450230558
63170400220702	UM2422-MEBL53	24	2200K	ON/OFF	ME	53	Negro	8424450230602
63170400220802	UM2422-T3BL53	24	2200K	ON/OFF	T3	53	Negro	8424450230657
63170400220902	UM2422-APZBL53	24	2200K	ON/OFF	APZ	53	Negro	8424450230701
63170400221302	UM2422-SCLBL53	24	2200K	ON/OFF	SCL	53	Negro	8424450230930
63170400300102	UM2430-PBL53	24	3000K	ON/OFF	P	53	Negro	8424450230527
63170400300202	UM2430-SPBL53	24	3000K	ON/OFF	SP	53	Negro	8424450216057
63170400300502	UM2430-KBL53	24	3000K	ON/OFF	K	53	Negro	8424450216064
63170400300602	UM2430-T2BL53	24	3000K	ON/OFF	T2	53	Negro	8424450230565
63170400300702	UM2430-MEBL53	24	3000K	ON/OFF	ME	53	Negro	8424450230619
63170400300802	UM2430-T3BL53	24	3000K	ON/OFF	T3	53	Negro	8424450230664
63170400300902	UM2430-APZBL53	24	3000K	ON/OFF	APZ	53	Negro	8424450230718
63170400301302	UM2430-SCLBL53	24	3000K	ON/OFF	SCL	53	Negro	8424450230954
63170400400102	UM2440-PBL53	24	4000K	ON/OFF	P	53	Negro	8424450214824
63170400400202	UM2440-SPBL53	24	4000K	ON/OFF	SP	53	Negro	8424450216071
63170400400502	UM2440-KBL53	24	4000K	ON/OFF	K	53	Negro	8424450216088
63170400400602	UM2440-T2BL53	24	4000K	ON/OFF	T2	53	Negro	8424450230572
63170400400702	UM2440-MEBL53	24	4000K	ON/OFF	ME	53	Negro	8424450230626
63170400400802	UM2440-T3BL53	24	4000K	ON/OFF	T3	53	Negro	8424450230671
63170400400902	UM2440-APZBL53	24	4000K	ON/OFF	APZ	53	Negro	8424450230725
63170400401302	UM2440-SCLBL53	24	4000K	ON/OFF	SCL	53	Negro	8424450230978
63170401180102	UM2418D-PBL53	24	PC Ámbar	Dimming	P	53	Negro	8424450259665
63170401180202	UM2418D-SPBL53	24	PC Ámbar	Dimming	SP	53	Negro	8424450259672
63170401180502	UM2418D-KBL53	24	PC Ámbar	Dimming	K	53	Negro	8424450259689
63170401180602	UM2418D-T2BL53	24	PC Ámbar	Dimming	T2	53	Negro	8424450259696
63170401180702	UM2418D-MEBL53	24	PC Ámbar	Dimming	ME	53	Negro	8424450259702
63170401180802	UM2418D-T3BL53	24	PC Ámbar	Dimming	T3	53	Negro	8424450259719
63170401180902	UM2418D-APZBL53	24	PC Ámbar	Dimming	APZ	53	Negro	8424450259726
63170401181302	UM2418D-SCLBL53	24	PC Ámbar	Dimming	SCL	53	Negro	8424450259733
63170401220102	UM2422D-PBL53	24	2200K	Dimming	P	53	Negro	8424450222348
63170401220202	UM2422D-SPBL53	24	2200K	Dimming	SP	53	Negro	8424450215968
63170401220502	UM2422D-KBL53	24	2200K	Dimming	K	53	Negro	8424450215975
63170401220602	UM2422D-T2BL53	24	2200K	Dimming	T2	53	Negro	8424450222355
63170401220702	UM2422D-MEBL53	24	2200K	Dimming	ME	53	Negro	8424450222362
63170401220802	UM2422D-T3BL53	24	2200K	Dimming	T3	53	Negro	8424450222379
63170401220902	UM2422D-APZBL53	24	2200K	Dimming	APZ	53	Negro	8424450222386

URBAN MAIA



REF. PEDIDO	REF. LÓGICA	Nº LEDs		CONTROL	TIPO DE ÓPTICA	POTENCIA (W)		EAN13
Serie E								
63170401221302	UM2422D-SCLBL53	24	2200K	Dimming	SCL	53	Negro	8424450230879
63170401300102	UM2430D-PBL53	24	3000K	Dimming	P	53	Negro	8424450222409
63170401300202	UM2430D-SPBL53	24	3000K	Dimming	SP	53	Negro	8424450215982
63170401300502	UM2430D-KBL53	24	3000K	Dimming	K	53	Negro	8424450215999
63170401300602	UM2430D-T2BL53	24	3000K	Dimming	T2	53	Negro	8424450222416
63170401300702	UM2430D-MEBL53	24	3000K	Dimming	ME	53	Negro	8424450222423
63170401300802	UM2430D-T3BL53	24	3000K	Dimming	T3	53	Negro	8424450222430
63170401300902	UM2430D-APZBL53	24	3000K	Dimming	APZ	53	Negro	8424450222447
63170401301302	UM2430D-SCLBL53	24	3000K	Dimming	SCL	53	Negro	8424450230886
63170401400102	UM2440D-PBL53	24	4000K	Dimming	P	53	Negro	8424450213247
63170401400202	UM2440D-SPBL53	24	4000K	Dimming	SP	53	Negro	8424450216002
63170401400502	UM2440D-KBL53	24	4000K	Dimming	K	53	Negro	8424450209370
63170401400602	UM2440D-T2BL53	24	4000K	Dimming	T2	53	Negro	8424450222461
63170401400702	UM2440D-MEBL53	24	4000K	Dimming	ME	53	Negro	8424450222478
63170401400802	UM2440D-T3BL53	24	4000K	Dimming	T3	53	Negro	8424450222485
63170401400902	UM2440D-APZBL53	24	4000K	Dimming	APZ	53	Negro	8424450222492
63170401401302	UM2440D-SCLBL53	24	4000K	Dimming	SCL	53	Negro	8424450230893

REF. PEDIDO	REF. LÓGICA	Nº LEDs		CONTROL	TIPO DE ÓPTICA	POTENCIA (W)		EAN13
Serie E-4								
66071400180102	UM41218-PBL40	12	PC Ámbar	Programable	P	40	Negro	8424450260135
66071400180202	UM41218-SPBL40	12	PC Ámbar	Programable	SP	40	Negro	8424450260142
66071400180502	UM41218-KBL40	12	PC Ámbar	Programable	K	40	Negro	8424450260159
66071400180602	UM41218-T2BL40	12	PC Ámbar	Programable	T2	40	Negro	8424450260166
66071400180702	UM41218-MEBL40	12	PC Ámbar	Programable	ME	40	Negro	8424450260173
66071400180802	UM41218-T3BL40	12	PC Ámbar	Programable	T3	40	Negro	8424450260180
66071400180902	UM41218-APZBL40	12	PC Ámbar	Programable	APZ	40	Negro	8424450260197
66071400181302	UM41218-SCLBL40	12	PC Ámbar	Programable	SCL	40	Negro	8424450260203
66071400220102	UM41222-PBL40	12	2200K	Programable	P	40	Negro	8424450242155
66071400220202	UM41222-SPBL40	12	2200K	Programable	SP	40	Negro	8424450242162
66071400220502	UM41222-KBL40	12	2200K	Programable	K	40	Negro	8424450242179
66071400220602	UM41222-T2BL40	12	2200K	Programable	T2	40	Negro	8424450242186
66071400220702	UM41222-MEBL40	12	2200K	Programable	ME	40	Negro	8424450242193
66071400220802	UM41222-T3BL40	12	2200K	Programable	T3	40	Negro	8424450242209
66071400220902	UM41222-APZBL40	12	2200K	Programable	APZ	40	Negro	8424450242216
66071400221302	UM41222-SCLBL40	12	2200K	Programable	SCL	40	Negro	8424450242230
66071400300102	UM41230-PBL40	12	3000K	Programable	P	40	Negro	8424450242339
66071400300202	UM41230-SPBL40	12	3000K	Programable	SP	40	Negro	8424450242346
66071400300502	UM41230-KBL40	12	3000K	Programable	K	40	Negro	8424450242353
66071400300602	UM41230-T2BL40	12	3000K	Programable	T2	40	Negro	8424450242360
66071400300702	UM41230-MEBL40	12	3000K	Programable	ME	40	Negro	8424450242377
66071400300802	UM41230-T3BL40	12	3000K	Programable	T3	40	Negro	8424450242384
66071400300902	UM41230-APZBL40	12	3000K	Programable	APZ	40	Negro	8424450242391
66071400301302	UM41230-SCLBL40	12	3000K	Programable	SCL	40	Negro	8424450242414
66071400400102	UM41240-PBL40	12	4000K	Programable	P	40	Negro	8424450242421
66071400400202	UM41240-SPBL40	12	4000K	Programable	SP	40	Negro	8424450242438
66071400400502	UM41240-KBL40	12	4000K	Programable	K	40	Negro	8424450242445
66071400400602	UM41240-T2BL40	12	4000K	Programable	T2	40	Negro	8424450242452
66071400400702	UM41240-MEBL40	12	4000K	Programable	ME	40	Negro	8424450242469
66071400400802	UM41240-T3BL40	12	4000K	Programable	T3	40	Negro	8424450242476
66071400400902	UM41240-APZBL40	12	4000K	Programable	APZ	40	Negro	8424450242483
66071400401302	UM41240-SCLBL40	12	4000K	Programable	SCL	40	Negro	8424450242506
66170400180102	UM42418-PBL75	24	PC Ámbar	Programable	P	75	Negro	8424450260210
66170400180202	UM42418-SPBL75	24	PC Ámbar	Programable	SP	75	Negro	8424450260227
66170400180502	UM42418-KBL75	24	PC Ámbar	Programable	K	75	Negro	8424450260234

ALUMBRADO EXTERIOR URBANO Y RESIDENCIAL

URBAN MAIA





REF. PEDIDO	REF. LÓGICA	Nº LEDs	💡	CONTROL	TIPO DE ÓPTICA	POTENCIA (W)	👤	EAN13
Serie E-4								
66170400180602	UM42418-T2BL75	24	PC Ámbar	Programable	T2	75	Negro	8424450260241
66170400180702	UM42418-MEBL75	24	PC Ámbar	Programable	ME	75	Negro	8424450260258
66170400180802	UM42418-T3BL75	24	PC Ámbar	Programable	T3	75	Negro	8424450260265
66170400180902	UM42418-APZBL75	24	PC Ámbar	Programable	APZ	75	Negro	8424450260272
66170400181302	UM42418-SCLBL75	24	PC Ámbar	Programable	SCL	75	Negro	8424450260289
66170400220102	UM42422-PBL75	24	2200K	Programable	P	75	Negro	8424450242513
66170400220202	UM42422-SPBL75	24	2200K	Programable	SP	75	Negro	8424450242520
66170400220502	UM42422-KBL75	24	2200K	Programable	K	75	Negro	8424450242537
66170400220602	UM42422-T2BL75	24	2200K	Programable	T2	75	Negro	8424450242544
66170400220702	UM42422-MEBL75	24	2200K	Programable	ME	75	Negro	8424450242551
66170400220802	UM42422-T3BL75	24	2200K	Programable	T3	75	Negro	8424450242568
66170400220902	UM42422-APZBL75	24	2200K	Programable	APZ	75	Negro	8424450242575
66170400221302	UM42422-SCLBL75	24	2200K	Programable	SCL	75	Negro	8424450242599
66170400300102	UM42430-PBL75	24	3000K	Programable	P	75	Negro	8424450242698
66170400300202	UM42430-SPBL75	24	3000K	Programable	SP	75	Negro	8424450242704
66170400300502	UM42430-KBL75	24	3000K	Programable	K	75	Negro	8424450242711
66170400300602	UM42430-T2BL75	24	3000K	Programable	T2	75	Negro	8424450242728
66170400300702	UM42430-MEBL75	24	3000K	Programable	ME	75	Negro	8424450242735
66170400300802	UM42430-T3BL75	24	3000K	Programable	T3	75	Negro	8424450242742
66170400300902	UM42430-APZBL75	24	3000K	Programable	APZ	75	Negro	8424450242759
66170400301302	UM42430-SCLBL75	24	3000K	Programable	SCL	75	Negro	8424450242773
66170400400102	UM42440-PBL75	24	4000K	Programable	P	75	Negro	8424450242780
66170400400202	UM42440-SPBL75	24	4000K	Programable	SP	75	Negro	8424450242797
66170400400502	UM42440-KBL75	24	4000K	Programable	K	75	Negro	8424450242803
66170400400602	UM42440-T2BL75	24	4000K	Programable	T2	75	Negro	8424450242810
66170400400702	UM42440-MEBL75	24	4000K	Programable	ME	75	Negro	8424450242827
66170400400802	UM42440-T3BL75	24	4000K	Programable	T3	75	Negro	8424450242834
66170400400902	UM42440-APZBL75	24	4000K	Programable	APZ	75	Negro	8424450242841
66170400401302	UM42440-SCLBL75	24	4000K	Programable	SCL	75	Negro	8424450242865

REF. PEDIDO	REF. LÓGICA	Nº LEDs	💡	CONTROL	TIPO DE ÓPTICA	POTENCIA (W)	👤	EAN13
Serie Z								
66091400180102	UMZ1218-PBL40	12	PC Ámbar	Telegestión	P	40	Negro	8424450260333
66091400180202	UMZ1218-SPBL40	12	PC Ámbar	Telegestión	SP	40	Negro	8424450260340
66091400180502	UMZ1218-KBL40	12	PC Ámbar	Telegestión	K	40	Negro	8424450260357
66091400180602	UMZ1218-T2BL40	12	PC Ámbar	Telegestión	T2	40	Negro	8424450260364
66091400180702	UMZ1218-MEBL40	12	PC Ámbar	Telegestión	ME	40	Negro	8424450260371
66091400180802	UMZ1218-T3BL40	12	PC Ámbar	Telegestión	T3	40	Negro	8424450260388
66091400180902	UMZ1218-APZBL40	12	PC Ámbar	Telegestión	APZ	40	Negro	8424450260395
66091400181302	UMZ1218-SCLBL40	12	PC Ámbar	Telegestión	SCL	40	Negro	8424450269794
66091400220102	UMZ1222-PBL40	12	2200K	Telegestión	P	40	Negro	8424450221419
66091400220202	UMZ1222-SPBL40	12	2200K	Telegestión	SP	40	Negro	8424450228791
66091400220502	UMZ1222-KBL40	12	2200K	Telegestión	K	40	Negro	8424450221426
66091400220602	UMZ1222-T2BL40	12	2200K	Telegestión	T2	40	Negro	8424450221433
66091400220702	UMZ1222-MEBL40	12	2200K	Telegestión	ME	40	Negro	8424450221440
66091400220802	UMZ1222-T3BL40	12	2200K	Telegestión	T3	40	Negro	8424450221457
66091400220902	UMZ1222-APZBL40	12	2200K	Telegestión	APZ	40	Negro	8424450221464
66091400221302	UMZ1222-SCLBL40	12	2200K	Telegestión	SCL	40	Negro	8424450228920
66091400300102	UMZ1230-PBL40	12	3000K	Telegestión	P	40	Negro	8424450221488
66091400300202	UMZ1230-SPBL40	12	3000K	Telegestión	SP	40	Negro	8424450228807
66091400300502	UMZ1230-KBL40	12	3000K	Telegestión	K	40	Negro	8424450221495
66091400300602	UMZ1230-T2BL40	12	3000K	Telegestión	T2	40	Negro	8424450221501
66091400300702	UMZ1230-MEBL40	12	3000K	Telegestión	ME	40	Negro	8424450221518
66091400300802	UMZ1230-T3BL40	12	3000K	Telegestión	T3	40	Negro	8424450221525
66091400300902	UMZ1230-APZBL40	12	3000K	Telegestión	APZ	40	Negro	8424450221532

URBAN MAIA



REF. PEDIDO	REF. LÓGICA	Nº LEDs		CONTROL	TIPO DE ÓPTICA	POTENCIA (W)		EAN13
Serie Z								
66091400301302	UMZ1230-SCLBL40	12	3000K	Telegestión	SCL	40	Negro	8424450228944
66091400400102	UMZ1240-PBL40	12	4000K	Telegestión	P	40	Negro	8424450221556
66091400400202	UMZ1240-SPBL40	12	4000K	Telegestión	SP	40	Negro	8424450228814
66091400400502	UMZ1240-KBL40	12	4000K	Telegestión	K	40	Negro	8424450213902
66091400400602	UMZ1240-T2BL40	12	4000K	Telegestión	T2	40	Negro	8424450221563
66091400400702	UMZ1240-MEBL40	12	4000K	Telegestión	ME	40	Negro	8424450221570
66091400400802	UMZ1240-T3BL40	12	4000K	Telegestión	T3	40	Negro	8424450221587
66091400400902	UMZ1240-APZBL40	12	4000K	Telegestión	APZ	40	Negro	8424450221013
66091400401302	UMZ1240-SCLBL40	12	4000K	Telegestión	SCL	40	Negro	8424450228951
66190400180102	UMZ2418-PBL75	24	PC Ámbar	Telegestión	P	75	Negro	8424450260401
66190400180202	UMZ2418-SPBL75	24	PC Ámbar	Telegestión	SP	75	Negro	8424450260418
66190400180502	UMZ2418-KBL75	24	PC Ámbar	Telegestión	K	75	Negro	8424450260425
66190400180602	UMZ2418-T2BL75	24	PC Ámbar	Telegestión	T2	75	Negro	8424450260432
66190400180702	UMZ2418-MEBL75	24	PC Ámbar	Telegestión	ME	75	Negro	8424450260449
66190400180802	UMZ2418-T3BL75	24	PC Ámbar	Telegestión	T3	75	Negro	8424450260456
66190400180902	UMZ2418-APZBL75	24	PC Ámbar	Telegestión	APZ	75	Negro	8424450260463
66190400181302	UMZ2418-SCLBL75	24	PC Ámbar	Telegestión	SCL	75	Negro	8424450260470
66190400220102	UMZ2422-PBL75	24	2200K	Telegestión	P	75	Negro	8424450221709
66190400220202	UMZ2422-SPBL75	24	2200K	Telegestión	SP	75	Negro	8424450228708
66190400220502	UMZ2422-KBL75	24	2200K	Telegestión	K	75	Negro	8424450221716
66190400220602	UMZ2422-T2BL75	24	2200K	Telegestión	T2	75	Negro	8424450221723
66190400220702	UMZ2422-MEBL75	24	2200K	Telegestión	ME	75	Negro	8424450221730
66190400220802	UMZ2422-T3BL75	24	2200K	Telegestión	T3	75	Negro	8424450221747
66190400220902	UMZ2422-APZBL75	24	2200K	Telegestión	APZ	75	Negro	8424450221754
66190400221302	UMZ2422-SCLBL75	24	2200K	Telegestión	SCL	75	Negro	8424450228746
66190400300102	UMZ2430-PBL75	24	3000K	Telegestión	P	75	Negro	8424450221778
66190400300202	UMZ2430-SPBL75	24	3000K	Telegestión	SP	75	Negro	8424450228715
66190400300502	UMZ2430-KBL75	24	3000K	Telegestión	K	75	Negro	8424450221785
66190400300602	UMZ2430-T2BL75	24	3000K	Telegestión	T2	75	Negro	8424450221792
66190400300702	UMZ2430-MEBL60	24	3000K	Telegestión	ME	75	Negro	8424450221808
66190400300802	UMZ2430-T3BL75	24	3000K	Telegestión	T3	75	Negro	8424450221815
66190400300902	UMZ2430-APZBL75	24	3000K	Telegestión	APZ	75	Negro	8424450221822
66190400301302	UMZ2430-SCLBL75	24	3000K	Telegestión	SCL	75	Negro	8424450228753
66190400400102	UMZ2440-PBL75	24	4000K	Telegestión	P	75	Negro	8424450221846
66190400400202	UMZ2440-SPBL75	24	4000K	Telegestión	SP	75	Negro	8424450228722
66190400400502	UMZ2440-KBL75	24	4000K	Telegestión	K	75	Negro	8424450214459
66190400400602	UMZ2440-T2BL75	24	4000K	Telegestión	T2	75	Negro	8424450221853
66190400400702	UMZ2440-MEBL75	24	4000K	Telegestión	ME	75	Negro	8424450221860
66190400400802	UMZ2440-T3BL75	24	4000K	Telegestión	T3	75	Negro	8424450221877
66190400400902	UMZ2440-APZBL75	24	4000K	Telegestión	APZ	75	Negro	8424450221884
66190400401302	UMZ2440-SCLBL75	24	4000K	Telegestión	SCL	75	Negro	8424450228760



URBAN MAIA

ALUMBRADO EXTERIOR URBANO Y RESIDENCIAL



FAROS ORNAMENTALES



REF. PEDIDO	REF. LÓGICA	Nº LEDs		CONTROL	TIPO DE ÓPTICA	POTENCIA (W)		EAN13
Villa								
63070100180102	VI1218-PBL29	12	PC Ámbar	ON/OFF	P	29	Negro	8424450262078
63070100180202	VI1218-SPBL29	12	PC Ámbar	ON/OFF	SP	29	Negro	8424450262085
63070100180602	VI1218-T2BL29	12	PC Ámbar	ON/OFF	T2	29	Negro	8424450262092
63070100180702	VI1218-MEBL29	12	PC Ámbar	ON/OFF	ME	29	Negro	8424450262108
63070100180802	VI1218-T3BL29	12	PC Ámbar	ON/OFF	T3	29	Negro	8424450262115
63070100180902	VI1218-APZBL29	12	PC Ámbar	ON/OFF	APZ	29	Negro	8424450262122
63070100181302	VI1218-SCLBL29	12	PC Ámbar	ON/OFF	SCL	29	Negro	8424450262139
63070100220102	VI1222-PBL29	12	2200K	ON/OFF	P	29	Negro	842445026240120
63070100220202	VI1222-SPBL29	12	2200K	ON/OFF	SP	29	Negro	8424450235409
63070100220602	VI1222-T2BL29	12	2200K	ON/OFF	T2	29	Negro	8424450262153
63070100220702	VI1222-MEBL29	12	2200K	ON/OFF	ME	29	Negro	8424450262160
63070100220802	VI1222-T3BL29	12	2200K	ON/OFF	T3	29	Negro	8424450262177
63070100220902	VI1222-APZBL29	12	2200K	ON/OFF	APZ	29	Negro	8424450262184
63070100221302	VI1222-SCLBL29	12	2200K	ON/OFF	SCL	29	Negro	8424450262207
63070100300102	VI1230-PBL29	12	3000K	ON/OFF	P	29	Negro	8424450201640
63070100300202	VI1230-SPBL29	12	3000K	ON/OFF	SP	29	Negro	8424450206706
63070100300602	VI1230-T2BL29	12	3000K	ON/OFF	T2	29	Negro	8424450262214
63070100300702	VI1230-MEBL29	12	3000K	ON/OFF	ME	29	Negro	8424450262221
63070100300802	VI1230-T3BL29	12	3000K	ON/OFF	T3	29	Negro	8424450262238
63070100300902	VI1230-APZBL29	12	3000K	ON/OFF	APZ	29	Negro	8424450262245
63070100301302	VI1230-SCLBL29	12	3000K	ON/OFF	SCL	29	Negro	8424450262252
63070100400102	VI1240-PBL29	12	4000K	ON/OFF	P	29	Negro	8424450200865
63070100400202	VI1240-SPBL29	12	4000K	ON/OFF	SP	29	Negro	8424450202593
63070100400602	VI1240-T2BL29	12	4000K	ON/OFF	T2	29	Negro	8424450262269
63070100400702	VI1240-MEBL29	12	4000K	ON/OFF	ME	29	Negro	8424450262276
63070100400802	VI1240-T3BL29	12	4000K	ON/OFF	T3	29	Negro	8424450262283
63070100400902	VI1240-APZBL29	12	4000K	ON/OFF	APZ	29	Negro	8424450262290
63070100401302	VI1240-SCLBL29	12	4000K	ON/OFF	SCL	29	Negro	8424450262306
63070101180102	VI1218D-PBL29	12	PC Ámbar	Dimming	P	29	Negro	8424450262313
63070101180202	VI1218D-SPBL29	12	PC Ámbar	Dimming	SP	29	Negro	8424450262320
63070101180602	VI1218D-T2BL29	12	PC Ámbar	Dimming	T2	29	Negro	8424450262337
63070101180702	VI1218D-MEBL29	12	PC Ámbar	Dimming	ME	29	Negro	8424450262344
63070101180802	VI1218D-T3BL29	12	PC Ámbar	Dimming	T3	29	Negro	8424450262351
63070101180902	VI1218D-APZBL29	12	PC Ámbar	Dimming	APZ	29	Negro	8424450262368
63070101181302	VI1218D-SCLBL29	12	PC Ámbar	Dimming	SCL	29	Negro	8424450262375
63070101220102	VI1222D-PBL29	12	2200K	Dimming	P	29	Negro	8424450213605
63070101220202	VI1222D-SPBL29	12	2200K	Dimming	SP	29	Negro	8424450232958
63070101220602	VI1222D-T2BL29	12	2200K	Dimming	T2	29	Negro	8424450262382
63070101220702	VI1222D-MEBL29	12	2200K	Dimming	ME	29	Negro	8424450262399
63070101220802	VI1222D-T3BL29	12	2200K	Dimming	T3	29	Negro	8424450262405
63070101220902	VI1222D-APZBL29	12	2200K	Dimming	APZ	29	Negro	8424450213612
63070101221302	VI1222D-SCLBL29	12	2200K	Dimming	SCL	29	Negro	8424450262412
63070101300102	VI1230D-PBL29	12	3000K	Dimming	P	29	Negro	8424450232934
63070101300202	VI1230D-SPBL29	12	3000K	Dimming	SP	29	Negro	8424450219676
63070101300602	VI1230D-T2BL29	12	3000K	Dimming	T2	29	Negro	8424450262429
63070101300702	VI1230D-MEBL29	12	3000K	Dimming	ME	29	Negro	8424450262436
63070101300802	VI1230D-T3BL29	12	3000K	Dimming	T3	29	Negro	8424450232927
63070101300902	VI1230D-APZBL29	12	3000K	Dimming	APZ	29	Negro	8424450262443
63070101301302	VI1230D-SCLBL29	12	3000K	Dimming	SCL	29	Negro	8424450262450
63070101400102	VI1240D-PBL29	12	4000K	Dimming	P	29	Negro	8424450232910
63070101400202	VI1240D-SPBL29	12	4000K	Dimming	SP	29	Negro	8424450232903
63070101400602	VI1240D-T2BL29	12	4000K	Dimming	T2	29	Negro	8424450262467
63070101400702	VI1240D-MEBL29	12	4000K	Dimming	ME	29	Negro	8424450262474
63070101400802	VI1240D-T3BL29	12	4000K	Dimming	T3	29	Negro	8424450262481
63070101400902	VI1240D-APZBL29	12	4000K	Dimming	APZ	29	Negro	8424450262498
63070101401302	VI1240D-SCLBL29	12	4000K	Dimming	SCL	29	Negro	8424450262504

FAROS ORNAMENTALES



REF. PEDIDO	REF. LÓGICA	Nº LEDs		CONTROL	TIPO DE ÓPTICA	POTENCIA (W)		EAN13
Villa								
63071100180102	VI1218-PBL39	12	PC Ámbar	ON/OFF	P	39	Negro	8424450262962
63071100180202	VI1218-SPBL39	12	PC Ámbar	ON/OFF	SP	39	Negro	8424450262979
63071100180602	VI1218-T2BL39	12	PC Ámbar	ON/OFF	T2	39	Negro	8424450262986
63071100180702	VI1218-MEBL39	12	PC Ámbar	ON/OFF	ME	39	Negro	8424450262993
63071100180802	VI1218-T3BL39	12	PC Ámbar	ON/OFF	T3	39	Negro	8424450263006
63071100180902	VI1218-APZBL39	12	PC Ámbar	ON/OFF	APZ	39	Negro	8424450263013
63071100181302	VI1218-SCLBL39	12	PC Ámbar	ON/OFF	SCL	39	Negro	8424450263020
63071100220102	VI1222-PBL39	12	2200K	ON/OFF	P	39	Negro	8424450232712
63071100220202	VI1222-SPBL39	12	2200K	ON/OFF	SP	39	Negro	8424450232705
63071100220602	VI1222-T2BL39	12	2200K	ON/OFF	T2	39	Negro	8424450263037
63071100220702	VI1222-MEBL39	12	2200K	ON/OFF	ME	39	Negro	8424450263044
63071100220802	VI1222-T3BL39	12	2200K	ON/OFF	T3	39	Negro	8424450263051
63071100220902	VI1222-APZBL39	12	2200K	ON/OFF	APZ	39	Negro	8424450263068
63071100221302	VI1222-SCLBL39	12	2200K	ON/OFF	SCL	39	Negro	8424450263082
63071100300102	VI1230-PBL39	12	3000K	ON/OFF	P	39	Negro	8424450232699
63071100300202	VI1230-SPBL39	12	3000K	ON/OFF	SP	39	Negro	8424450206768
63071100300602	VI1230-T2BL39	12	3000K	ON/OFF	T2	39	Negro	8424450263099
63071100300702	VI1230-MEBL39	12	3000K	ON/OFF	ME	39	Negro	8424450263105
63071100300802	VI1230-T3BL39	12	3000K	ON/OFF	T3	39	Negro	8424450263112
63071100300902	VI1230-APZBL39	12	3000K	ON/OFF	APZ	39	Negro	8424450263129
63071100301302	VI1230-SCLBL39	12	3000K	ON/OFF	SCL	39	Negro	8424450263136
63071100400102	VI1240-PBL39	12	4000K	ON/OFF	P	39	Negro	8424450232682
63071100400202	VI1240-SPBL39	12	4000K	ON/OFF	SP	39	Negro	8424450212646
63071100400602	VI1240-T2BL39	12	4000K	ON/OFF	T2	39	Negro	8424450263143
63071100400702	VI1240-MEBL39	12	4000K	ON/OFF	ME	39	Negro	8424450263150
63071100400802	VI1240-T3BL39	12	4000K	ON/OFF	T3	39	Negro	8424450263167
63071100400902	VI1240-APZBL39	12	4000K	ON/OFF	APZ	39	Negro	8424450263174
63071100401302	VI1240-SCLBL39	12	4000K	ON/OFF	SCL	39	Negro	8424450263181
63071101180102	VI1218D-PBL39	12	PC Ámbar	Dimming	P	39	Negro	8424450263198
63071101180202	VI1218D-SPBL39	12	PC Ámbar	Dimming	SP	39	Negro	8424450263204
63071101180602	VI1218D-T2BL39	12	PC Ámbar	Dimming	T2	39	Negro	8424450263211
63071101180702	VI1218D-MEBL39	12	PC Ámbar	Dimming	ME	39	Negro	8424450263228
63071101180802	VI1218D-T3BL39	12	PC Ámbar	Dimming	T3	39	Negro	8424450263235
63071101180902	VI1218D-APZBL39	12	PC Ámbar	Dimming	APZ	39	Negro	8424450263242
63071101181302	VI1218D-SCLBL39	12	PC Ámbar	Dimming	SCL	39	Negro	8424450263259
63071101220102	VI1222D-PBL39	12	2200K	Dimming	P	39	Negro	8424450248348
63071101220202	VI1222D-SPBL39	12	2200K	Dimming	SP	39	Negro	8424450232644
63071101220602	VI1222D-T2BL39	12	2200K	Dimming	T2	39	Negro	8424450251768
63071101220702	VI1222D-PBL39	12	2200K	Dimming	ME	39	Negro	8424450251348
63071101220802	VI1222D-T3BL39	12	2200K	Dimming	T3	39	Negro	8424450263266
63071101220902	VI1222D-APZBL39	12	2200K	Dimming	APZ	39	Negro	8424450232620
63071101221302	VI1222D-SCLBL39	12	2200K	Dimming	SCL	39	Negro	8424450251775
63071101300102	VI1230D-PBL39	12	3000K	Dimming	P	39	Negro	8424450236543
63071101300202	VI1230D-SPBL39	12	3000K	Dimming	SP	39	Negro	8424450232613
63071101300602	VI1230D-T2BL39	12	3000K	Dimming	T2	39	Negro	8424450263273
63071101300702	VI1230D-MEBL39	12	3000K	Dimming	ME	39	Negro	8424450263280
63071101300802	VI1230D-T3BL39	12	3000K	Dimming	T3	39	Negro	8424450232590
63071101300902	VI1230D-APZBL39	12	3000K	Dimming	APZ	39	Negro	8424450232583
63071101301302	VI1230D-SCLBL39	12	3000K	Dimming	SCL	39	Negro	8424450263297
63071101400102	VI1240D-PBL39	12	4000K	Dimming	P	39	Negro	8424450225066
63071101400202	VI1240D-SPBL39	12	4000K	Dimming	SP	39	Negro	8424450224267
63071101400602	VI1240D-T2BL39	12	4000K	Dimming	T2	39	Negro	8424450263327
63071101400702	VI1240D-MEBL39	12	4000K	Dimming	ME	39	Negro	8424450263334
63071101400802	VI1240D-T3BL39	12	4000K	Dimming	T3	39	Negro	8424450263341
63071101400902	VI1240D-APZBL39	12	4000K	Dimming	APZ	39	Negro	8424450263358
63071101401302	VI1240D-SCLBL39	12	4000K	Dimming	SCL	39	Negro	8424450263365

ALUMBRADO EXTERIOR URBANO Y RESIDENCIAL



FAROS ORNAMENTALES



REF. PEDIDO	REF. LÓGICA	Nº LEDS		CONTROL	TIPO DE ÓPTICA	POTENCIA (W)		EAN13
Villa								
63170100180102	VI2418-PBL53	24	PC Ámbar	ON/OFF	P	53	Negro	8424450264188
63170100180202	VI2418-SPBL53	24	PC Ámbar	ON/OFF	SP	53	Negro	8424450264195
63170100180602	VI2418-T2BL53	24	PC Ámbar	ON/OFF	T2	53	Negro	8424450264201
63170100180702	VI2418-MEBL53	24	PC Ámbar	ON/OFF	ME	53	Negro	8424450264218
63170100180802	VI2418-T3BL53	24	PC Ámbar	ON/OFF	T3	53	Negro	8424450264225
63170100180902	VI2418-APZBL53	24	PC Ámbar	ON/OFF	APZ	53	Negro	8424450264232
63170100181302	VI2418-SCLBL53	24	PC Ámbar	ON/OFF	SCL	53	Negro	8424450264249
63170100220102	VI2422-PBL53	24	2200K	ON/OFF	P	53	Negro	8424450249895
63170100220202	VI2422-SPBL53	24	2200K	ON/OFF	SP	53	Negro	8424450213858
63170100220602	VI2422-T2BL53	24	2200K	ON/OFF	T2	53	Negro	8424450264256
63170100220702	VI2422-MEBL53	24	2200K	ON/OFF	ME	53	Negro	8424450264263
63170100220802	VI2422-T3BL53	24	2200K	ON/OFF	T3	53	Negro	8424450264270
63170100220902	VI2422-APZBL53	24	2200K	ON/OFF	APZ	53	Negro	8424450264287
63170100221302	VI2422-SCLBL53	24	2200K	ON/OFF	SCL	53	Negro	8424450264294
63170100300102	VI2430-PBL53	24	3000K	ON/OFF	P	53	Negro	8424450201657
63170100300202	VI2430-SPBL53	24	3000K	ON/OFF	SP	53	Negro	8424450232286
63170100300602	VI2430-T2BL53	24	3000K	ON/OFF	T2	53	Negro	8424450264300
63170100300702	VI2430-MEBL53	24	3000K	ON/OFF	ME	53	Negro	8424450264317
63170100300802	VI2430-T3BL53	24	3000K	ON/OFF	T3	53	Negro	8424450264324
63170100300902	VI2430-APZBL53	24	3000K	ON/OFF	APZ	53	Negro	8424450264331
63170100301302	VI2430-SCLBL53	24	3000K	ON/OFF	SCL	53	Negro	8424450264348
63170100400102	VI2440-PBL53	24	4000K	ON/OFF	P	53	Negro	8424450200896
63170100400202	VI2440-SPBL53	24	4000K	ON/OFF	SP	53	Negro	8424450213889
63170100400602	VI2440-T2BL53	24	4000K	ON/OFF	T2	53	Negro	8424450264355
63170100400702	VI2440-MEBL53	24	4000K	ON/OFF	ME	53	Negro	8424450264362
63170100400802	VI2440-T3BL53	24	4000K	ON/OFF	T3	53	Negro	8424450264379
63170100400902	VI2440-APZBL53	24	4000K	ON/OFF	APZ	53	Negro	8424450264386
63170100401302	VI2440-SCLBL53	24	4000K	ON/OFF	SCL	53	Negro	8424450264393
63170101180102	VI2418D-PBL53	24	PC Ámbar	Dimming	P	53	Negro	8424450264409
63170101180202	VI2418D-SPBL53	24	PC Ámbar	Dimming	SP	53	Negro	8424450264416
63170101180602	VI2418D-T2BL53	24	PC Ámbar	Dimming	T2	53	Negro	8424450264423
63170101180702	VI2418D-MEBL53	24	PC Ámbar	Dimming	ME	53	Negro	8424450264430
63170101180802	VI2418D-T3BL53	24	PC Ámbar	Dimming	T3	53	Negro	8424450264447
63170101180902	VI2418D-APZBL53	24	PC Ámbar	Dimming	APZ	53	Negro	8424450264454
63170101181302	VI2418D-SCLBL53	24	PC Ámbar	Dimming	SCL	53	Negro	8424450264461
63170101220102	VI2422D-PBL53	24	2200K	Dimming	P	53	Negro	8424450249925
63170101220202	VI2422D-SPBL53	24	2200K	Dimming	SP	53	Negro	8424450232255
63170101220602	VI2422D-T2BL53	24	2200K	Dimming	T2	53	Negro	8424450264478
63170101220702	VI2422D-MEBL53	24	2200K	Dimming	ME	53	Negro	8424450264485
63170101220802	VI2422D-T3BL53	24	2200K	Dimming	T3	53	Negro	8424450264492
63170101220902	VI2422D-APZBL53	24	2200K	Dimming	APZ	53	Negro	8424450264508
63170101221302	VI2422D-SCLBL53	24	2200K	Dimming	SCL	53	Negro	8424450264515
63170101300102	VI2430D-PBL53	24	3000K	Dimming	P	53	Negro	8424450214572
63170101300202	VI2430D-SPBL53	24	3000K	Dimming	SP	53	Negro	8424450232231
63170101300602	VI2430D-T2BL53	24	3000K	Dimming	T2	53	Negro	8424450247464
63170101300702	VI2430D-MEBL53	24	3000K	Dimming	ME	53	Negro	8424450264522
63170101300802	VI2430D-T3BL53	24	3000K	Dimming	T3	53	Negro	8424450247471
63170101300902	VI2430D-APZBL53	24	3000K	Dimming	APZ	53	Negro	8424450251799
63170101301302	VI2430D-SCLBL53	24	3000K	Dimming	SCL	53	Negro	8424450264539
63170101400102	VI2440D-PBL53	24	4000K	Dimming	P	53	Negro	8424450206140
63170101400202	VI2440D-SPBL53	24	4000K	Dimming	SP	53	Negro	8424450206638
63170101400602	VI2440D-T2BL53	24	4000K	Dimming	T2	53	Negro	8424450264546
63170101400702	VI2440D-MEBL53	24	4000K	Dimming	ME	53	Negro	8424450264553
63170101400802	VI2440D-T3BL53	24	4000K	Dimming	T3	53	Negro	8424450264560
63170101400902	VI2440D-APZBL53	24	4000K	Dimming	APZ	53	Negro	8424450264577
63170101401302	VI2440D-SCLBL53	24	4000K	Dimming	SCL	53	Negro	8424450264584

FAROS ORNAMENTALES



REF. PEDIDO	REF. LÓGICA	Nº LEDs		CONTROL	TIPO DE ÓPTICA	POTENCIA (W)		EAN13
Fernandina								
63070200180102	FE1218-PBL29	12	PC Ámbar	ON/OFF	P	29	Negro	8424450262566
63070200180202	FE1218-SPBL29	12	PC Ámbar	ON/OFF	SP	29	Negro	8424450262573
63070200180602	FE1218-T2BL29	12	PC Ámbar	ON/OFF	T2	29	Negro	8424450262580
63070200180702	FE1218-MEBL29	12	PC Ámbar	ON/OFF	ME	29	Negro	8424450262597
63070200180802	FE1218-T3BL29	12	PC Ámbar	ON/OFF	T3	29	Negro	8424450262603
63070200180902	FE1218-APZBL29	12	PC Ámbar	ON/OFF	APZ	29	Negro	8424450262610
63070200181302	FE1218-SCLBL29	12	PC Ámbar	ON/OFF	SCL	29	Negro	8424450262627
63070200220102	FE1222-PBL29	12	2200K	ON/OFF	P	29	Negro	8424450248263
63070200220202	FE1222-SPBL29	12	2200K	ON/OFF	SP	29	Negro	8424450232866
63070200220602	FE1222-T2BL29	12	2200K	ON/OFF	T2	29	Negro	8424450262634
63070200220702	FE1222-MEBL29	12	2200K	ON/OFF	ME	29	Negro	8424450262641
63070200220802	FE1222-T3BL29	12	2200K	ON/OFF	T3	29	Negro	8424450262658
63070200220902	FE1222-APZBL29	12	2200K	ON/OFF	APZ	29	Negro	8424450262665
63070200221302	FE1222-SCLBL29	12	2200K	ON/OFF	SCL	29	Negro	8424450262672
63070200300102	FE1230-PBL29	12	3000K	ON/OFF	P	29	Negro	8424450201763
63070200300202	FE1230-SPBL29	12	3000K	ON/OFF	SP	29	Negro	8424450201787
63070200300602	FE1230-T2BL29	12	3000K	ON/OFF	T2	29	Negro	8424450266168
63070200300702	FE1230-MEBL29	12	3000K	ON/OFF	ME	29	Negro	8424450266175
63070200300802	FE1230-T3BL29	12	3000K	ON/OFF	T3	29	Negro	8424450266182
63070200300902	FE1230-APZBL29	12	3000K	ON/OFF	APZ	29	Negro	8424450266199
63070200301302	FE1230-SCLBL29	12	3000K	ON/OFF	SCL	29	Negro	8424450266205
63070200400102	FE1240-PBL29	12	4000K	ON/OFF	P	29	Negro	8424450200889
63070200400202	FE1240-SPBL29	12	4000K	ON/OFF	SP	29	Negro	8424450232835
63070200400602	FE1240-T2BL29	12	4000K	ON/OFF	T2	29	Negro	8424450262689
63070200400702	FE1240-MEBL29	12	4000K	ON/OFF	ME	29	Negro	8424450262696
63070200400802	FE1240-T3BL29	12	4000K	ON/OFF	T3	29	Negro	8424450262702
63070200400902	FE1240-APZBL29	12	4000K	ON/OFF	APZ	29	Negro	8424450262719
63070200401302	FE1240-SCLBL29	12	4000K	ON/OFF	SCL	29	Negro	8424450262726
63070201180102	FE1218D-PBL29	12	PC Ámbar	Dimming	P	29	Negro	8424450262733
63070201180202	FE1218D-SPBL29	12	PC Ámbar	Dimming	SP	29	Negro	8424450262740
63070201180602	FE1218D-T2BL29	12	PC Ámbar	Dimming	T2	29	Negro	8424450262757
63070201180702	FE1218D-MEBL29	12	PC Ámbar	Dimming	ME	29	Negro	8424450262764
63070201180802	FE1218D-T3BL29	12	PC Ámbar	Dimming	T3	29	Negro	8424450262771
63070201180902	FE1218D-APZBL29	12	PC Ámbar	Dimming	APZ	29	Negro	8424450262788
63070201181302	FE1218D-SCLBL29	12	PC Ámbar	Dimming	SCL	29	Negro	8424450262795
63070201220102	FE1222D-PBL29	12	2200K	Dimming	P	29	Negro	8424450248294
63070201220202	FE1222D-SPBL29	12	2200K	Dimming	SP	29	Negro	8424450232798
63070201220602	FE1222D-T2BL29	12	2200K	Dimming	T2	29	Negro	8424450262801
63070201220702	FE1222D-MEBL29	12	2200K	Dimming	ME	29	Negro	8424450262818
63070201220802	FE1222D-T3BL29	12	2200K	Dimming	T3	29	Negro	8424450262825
63070201220902	FE1222D-APZBL29	12	2200K	Dimming	APZ	29	Negro	8424450262832
63070201221302	FE1222D-SCLBL29	12	2200K	Dimming	SCL	29	Negro	8424450262849
63070201300102	FE1230D-PBL29	12	3000K	Dimming	P	29	Negro	8424450208595
63070201300202	FE1230D-SPBL29	12	3000K	Dimming	SP	29	Negro	8424450219782
63070201300602	FE1230D-T2BL29	12	3000K	Dimming	T2	29	Negro	8424450262856
63070201300702	FE1230D-MEBL29	12	3000K	Dimming	ME	29	Negro	8424450262863
63070201300802	FE1230D-T3BL29	12	3000K	Dimming	T3	29	Negro	8424450262870
63070201300902	FE1230D-APZBL29	12	3000K	Dimming	APZ	29	Negro	8424450262887
63070201301302	FE1230D-SCLBL29	12	3000K	Dimming	SCL	29	Negro	8424450262894
63070201400102	FE1240D-PBL29	12	4000K	Dimming	P	29	Negro	8424450204931
63070201400202	FE1240D-SPBL29	12	4000K	Dimming	SP	29	Negro	8424450232750
63070201400602	FE1240D-T2BL29	12	4000K	Dimming	T2	29	Negro	8424450262900
63070201400702	FE1240D-MEBL29	12	4000K	Dimming	ME	29	Negro	8424450262917
63070201400802	FE1240D-T3BL29	12	4000K	Dimming	T3	29	Negro	8424450262924
63070201400902	FE1240D-APZBL29	12	4000K	Dimming	APZ	29	Negro	8424450262931
63070201401302	FE1240D-SCLBL29	12	4000K	Dimming	SCL	29	Negro	8424450262948

ALUMBRADO EXTERIOR URBANO Y RESIDENCIAL



FAROS ORNAMENTALES



REF. PEDIDO	REF. LÓGICA	Nº LEDs	💡	CONTROL	TIPO DE ÓPTICA	POTENCIA (W)	🖨️	EAN13
Fernandina								
63071200180102	FE1218-PBL39	12	PC Ámbar	ON/OFF	P	39	Negro	8424450263389
63071200180202	FE1218-SPBL39	12	PC Ámbar	ON/OFF	SP	39	Negro	8424450263396
63071200180602	FE1218-T2BL39	12	PC Ámbar	ON/OFF	T2	39	Negro	8424450263402
63071200180702	FE1218-MEBL39	12	PC Ámbar	ON/OFF	ME	39	Negro	8424450263419
63071200180802	FE1218-T3BL39	12	PC Ámbar	ON/OFF	T3	39	Negro	8424450263426
63071200180902	FE1218-APZBL39	12	PC Ámbar	ON/OFF	APZ	39	Negro	8424450263433
63071200181302	FE1218-SCLBL39	12	PC Ámbar	ON/OFF	SCL	39	Negro	8424450263440
63071200220102	FE1222-PBL39	12	2200K	ON/OFF	P	39	Negro	8424450248379
63071200220202	FE1222-SPBL39	12	2200K	ON/OFF	SP	39	Negro	8424450232552
63071200220602	FE1222-T2BL39	12	2200K	ON/OFF	T2	39	Negro	8424450263457
63071200220702	FE1222-MEBL39	12	2200K	ON/OFF	ME	39	Negro	8424450263464
63071200220802	FE1222-T3BL39	12	2200K	ON/OFF	T3	39	Negro	8424450263471
63071200220902	FE1222-APZBL39	12	2200K	ON/OFF	APZ	39	Negro	8424450263488
63071200221302	FE1222-SCLBL39	12	2200K	ON/OFF	SCL	39	Negro	8424450263495
63071200300102	FE1230-PBL39	12	3000K	ON/OFF	P	39	Negro	8424450247419
63071200300202	FE1230-SPBL39	12	3000K	ON/OFF	SP	39	Negro	8424450232521
63071200300602	FE1230-T2BL39	12	3000K	ON/OFF	T2	39	Negro	8424450263501
63071200300702	FE1230-MEBL39	12	3000K	ON/OFF	ME	39	Negro	8424450263518
63071200300802	FE1230-T3BL39	12	3000K	ON/OFF	T3	39	Negro	8424450263525
63071200300902	FE1230-APZBL39	12	3000K	ON/OFF	APZ	39	Negro	8424450263532
63071200301302	FE1230-SCLBL39	12	3000K	ON/OFF	SCL	39	Negro	8424450263549
63071200400102	FE1240-PBL39	12	4000K	ON/OFF	P	39	Negro	8424450248393
63071200400202	FE1240-SPBL39	12	4000K	ON/OFF	SP	39	Negro	8424450232507
63071200400602	FE1240-T2BL39	12	4000K	ON/OFF	T2	39	Negro	8424450263556
63071200400702	FE1240-MEBL39	12	4000K	ON/OFF	ME	39	Negro	8424450263563
63071200400802	FE1240-T3BL39	12	4000K	ON/OFF	T3	39	Negro	8424450263570
63071200400902	FE1240-APZBL39	12	4000K	ON/OFF	APZ	39	Negro	8424450213896
63071200401302	FE1240-SCLBL39	12	4000K	ON/OFF	SCL	39	Negro	8424450263587
63071201180102	FE1218D-PBL39	12	PC Ámbar	Dimming	P	39	Negro	8424450263594
63071201180202	FE1218D-SPBL39	12	PC Ámbar	Dimming	SP	39	Negro	8424450263600
63071201180602	FE1218D-T2BL39	12	PC Ámbar	Dimming	T2	39	Negro	8424450263617
63071201180702	FE1218D-MEBL39	12	PC Ámbar	Dimming	ME	39	Negro	8424450263624
63071201180802	FE1218D-T3BL39	12	PC Ámbar	Dimming	T3	39	Negro	8424450263631
63071201180902	FE1218D-APZBL39	12	PC Ámbar	Dimming	APZ	39	Negro	8424450263648
63071201181302	FE1218D-SCLBL39	12	PC Ámbar	Dimming	SCL	39	Negro	8424450263655
63071201220102	FE1222D-PBL39	12	2200K	Dimming	P	39	Negro	8424450248416
63071201220202	FE1222D-SPBL39	12	2200K	Dimming	SP	39	Negro	8424450232460
63071201220602	FE1222D-T2BL39	12	2200K	Dimming	T2	39	Negro	8424450263662
63071201220702	FE1222D-MEBL39	12	2200K	Dimming	ME	39	Negro	8424450263679
63071201220802	FE1222D-T3BL39	12	2200K	Dimming	T3	39	Negro	8424450263686
63071201220902	FE1222D-APZBL39	12	2200K	Dimming	APZ	39	Negro	8424450263693
63071201221302	FE1222D-SCLBL39	12	2200K	Dimming	SCL	39	Negro	8424450263709
63071201300102	FE1230D-PBL39	12	3000K	Dimming	P	39	Negro	8424450247716
63071201300202	FE1230D-SPBL39	12	3000K	Dimming	SP	39	Negro	8424450232453
63071201300602	FE1230D-T2BL39	12	3000K	Dimming	T2	39	Negro	8424450263716
63071201300702	FE1230D-MEBL39	12	3000K	Dimming	ME	39	Negro	8424450263723
63071201300802	FE1230D-T3BL39	12	3000K	Dimming	T3	39	Negro	8424450263730
63071201300902	FE1230D-APZBL39	12	3000K	Dimming	APZ	39	Negro	8424450263747
63071201301302	FE1230D-SCLBL39	12	3000K	Dimming	SCL	39	Negro	8424450263754
63071201400102	FE1240D-PBL39	12	4000K	Dimming	P	39	Negro	8424450248430
63071201400202	FE1240D-SPBL39	12	4000K	Dimming	SP	39	Negro	8424450232446
63071201400602	FE1240D-T2BL39	12	4000K	Dimming	T2	39	Negro	8424450263761
63071201400702	FE1240D-MEBL39	12	4000K	Dimming	ME	39	Negro	8424450263778
63071201400802	FE1240D-T3BL39	12	4000K	Dimming	T3	39	Negro	8424450263785
63071201400902	FE1240D-APZBL39	12	4000K	Dimming	APZ	39	Negro	8424450263792
63071201401302	FE1240D-SCLBL39	12	4000K	Dimming	SCL	39	Negro	8424450263808

FAROS ORNAMENTALES



REF. PEDIDO	REF. LÓGICA	Nº LEDs		CONTROL	TIPO DE ÓPTICA	POTENCIA (W)		EAN13
Fernandina								
63170200180102	FE2418-PBL53	24	PC Ámbar	ON/OFF	P	53	Negro	8424450264614
63170200180202	FE2418-SPBL53	24	PC Ámbar	ON/OFF	SP	53	Negro	8424450264621
63170200180602	FE2418-T2BL53	24	PC Ámbar	ON/OFF	T2	53	Negro	8424450264638
63170200180702	FE2418-MEBL53	24	PC Ámbar	ON/OFF	ME	53	Negro	8424450264645
63170200180802	FE2418-T3BL53	24	PC Ámbar	ON/OFF	T3	53	Negro	8424450264652
63170200180902	FE2418-APZBL53	24	PC Ámbar	ON/OFF	APZ	53	Negro	8424450264669
63170200181302	FE2418-SCLBL53	24	PC Ámbar	ON/OFF	SCL	53	Negro	8424450264676
63170200220102	FE2422-PBL53	24	2200K	ON/OFF	P	53	Negro	8424450209615
63170200220202	FE2422-SPBL53	24	2200K	ON/OFF	SP	53	Negro	8424450235188
63170200220602	FE2422-T2BL53	24	2200K	ON/OFF	T2	53	Negro	8424450264683
63170200220702	FE2422-MEBL53	24	2200K	ON/OFF	ME	53	Negro	8424450264690
63170200220802	FE2422-T3BL53	24	2200K	ON/OFF	T3	53	Negro	8424450264706
63170200220902	FE2422-APZBL53	24	2200K	ON/OFF	APZ	53	Negro	8424450264713
63170200221302	FE2422-SCLBL53	24	2200K	ON/OFF	SCL	53	Negro	8424450264720
63170200300102	FE2430-PBL53	24	3000K	ON/OFF	P	53	Negro	8424450249963
63170200300202	FE2430-SPBL53	24	3000K	ON/OFF	SP	53	Negro	8424450214930
63170200300602	FE2430-T2BL53	24	3000K	ON/OFF	T2	53	Negro	8424450264737
63170200300702	FE2430-MEBL53	24	3000K	ON/OFF	ME	53	Negro	8424450264744
63170200300802	FE2430-T3BL53	24	3000K	ON/OFF	T3	53	Negro	8424450264751
63170200300902	FE2430-APZBL53	24	3000K	ON/OFF	APZ	53	Negro	8424450264768
63170200301302	FE2430-SCLBL53	24	3000K	ON/OFF	SCL	53	Negro	8424450264775
63170200400102	FE2440-PBL53	24	4000K	ON/OFF	P	53	Negro	8424450200902
63170200400202	FE2440-SPBL53	24	4000K	ON/OFF	SP	53	Negro	8424450235157
63170200400602	FE2440-T2BL53	24	4000K	ON/OFF	T2	53	Negro	8424450264782
63170200400702	FE2440-MEBL53	24	4000K	ON/OFF	ME	53	Negro	8424450264799
63170200400802	FE2440-T3BL53	24	4000K	ON/OFF	T3	53	Negro	8424450264805
63170200400902	FE2440-APZBL53	24	4000K	ON/OFF	APZ	53	Negro	8424450214015
63170200401302	FE2440-SCLBL53	24	4000K	ON/OFF	SCL	53	Negro	8424450264812
63170201180102	FE2418D-PBL53	24	PC Ámbar	Dimming	P	53	Negro	8424450264829
63170201180202	FE2418D-SPBL53	24	PC Ámbar	Dimming	SP	53	Negro	8424450264836
63170201180602	FE2418D-T2BL53	24	PC Ámbar	Dimming	T2	53	Negro	8424450264843
63170201180702	FE2418D-MEBL53	24	PC Ámbar	Dimming	ME	53	Negro	8424450264850
63170201180802	FE2418D-T3BL53	24	PC Ámbar	Dimming	T3	53	Negro	8424450264867
63170201180902	FE2418D-APZBL53	24	PC Ámbar	Dimming	APZ	53	Negro	8424450264874
63170201181302	FE2418D-SCLBL53	24	PC Ámbar	Dimming	SCL	53	Negro	8424450264881
63170201220102	FE2422D-PBL53	24	2200K	Dimming	P	53	Negro	8424450235119
63170201220202	FE2422D-SPBL53	24	2200K	Dimming	SP	53	Negro	8424450233191
63170201220602	FE2422D-T2BL53	24	2200K	Dimming	T2	53	Negro	8424450264898
63170201220702	FE2422D-MEBL53	24	2200K	Dimming	ME	53	Negro	8424450264904
63170201220802	FE2422D-T3BL53	24	2200K	Dimming	T3	53	Negro	8424450264911
63170201220902	FE2422D-APZBL53	24	2200K	Dimming	APZ	53	Negro	8424450264928
63170201221302	FE2422D-SCLBL53	24	2200K	Dimming	SCL	53	Negro	8424450264935
63170201300102	FE2430D-PBL53	24	3000K	Dimming	P	53	Negro	8424450214589
63170201300202	FE2430D-SPBL53	24	3000K	Dimming	SP	53	Negro	8424450235072
63170201300602	FE2430D-T2BL53	24	3000K	Dimming	T2	53	Negro	8424450264942
63170201300702	FE2430D-MEBL53	24	3000K	Dimming	ME	53	Negro	8424450264959
63170201300802	FE2430D-T3BL53	24	3000K	Dimming	T3	53	Negro	8424450264966
63170201300902	FE2430D-APZBL53	24	3000K	Dimming	APZ	53	Negro	8424450264973
63170201301302	FE2430D-SCLBL53	24	3000K	Dimming	SCL	53	Negro	8424450264980
63170201400102	FE2440D-PBL53	24	4000K	Dimming	P	53	Negro	8424450203286
63170201400202	FE2440D-SPBL53	24	4000K	Dimming	SP	53	Negro	8424450235065
63170201400602	FE2440D-T2BL53	24	4000K	Dimming	T2	53	Negro	8424450264997
63170201400702	FE2440D-MEBL53	24	4000K	Dimming	ME	53	Negro	8424450265000
63170201400802	FE2440D-T3BL53	24	4000K	Dimming	T3	53	Negro	8424450265017
63170201400902	FE2440D-APZBL53	24	4000K	Dimming	APZ	53	Negro	8424450265024
63170201401302	FE2440D-SCLBL53	24	4000K	Dimming	SCL	53	Negro	8424450265031



ALUMBRADO EXTERIOR URBANO Y RESIDENCIAL

ACCESORIOS

REF. PEDIDO	REF. LÓGICA	DESCRIPCIÓN	EAN13
690401	VA60	Adaptador de Columna Ø60mm y Ø76mm para Farol	8424450208502
690409	VD-4	Difusor Frosted para Farol Villa. Policarbonato resistente UV (4 unidades)	8424450252000
690410	AA60	Adaptador de Columna Ø60mm para Alameda	8424450237922
690420	MA42	Adaptador de Columna Ø42mm para Maia	8424450252239



690401



690409

ZONAS DEPORTIVAS Y GRANDES ÁREAS



REF. PEDIDO	REF. LÓGICA	Nº LEDs	💡	CONTROL	TIPO DE ÓPTICA	POTENCIA (W)	🔧	EAN13
Proyector Flex								
67110000220401	FF9622-S60AL250	96	2200K	ON/OFF	S60	250	Aluminio	8424450266298
67110000221501	FF9622-S20AL250	96	2200K	ON/OFF	S20	250	Aluminio	8424450266304
67110000221601	FF9622-S40AL250	96	2200K	ON/OFF	S40	250	Aluminio	8424450266311
67110000300401	FF9630-S60AL250	96	3000K	ON/OFF	S60	250	Aluminio	8424450266359
67110000301501	FF9630-S20AL250	96	3000K	ON/OFF	S20	250	Aluminio	8424450266366
67110000301601	FF9630-S40AL250	96	3000K	ON/OFF	S40	250	Aluminio	8424450266373
67110000400401	FF9640-S60AL250	96	4000K	ON/OFF	S60	250	Aluminio	8424450266380
67110000401501	FF9640-S20AL250	96	4000K	ON/OFF	S20	250	Aluminio	8424450266397
67110000401601	FF9640-S40AL250	96	4000K	ON/OFF	S40	250	Aluminio	8424450266403
67110000500401	FF9650-S60AL250	96	5000K	ON/OFF	S60	250	Aluminio	8424450266410
67110000501501	FF9650-S20AL250	96	5000K	ON/OFF	S20	250	Aluminio	8424450266427
67110000501601	FF9650-S40AL250	96	5000K	ON/OFF	S40	250	Aluminio	8424450266434
67110100220401	FF9622-S60AL300	96	2200K	ON/OFF	S60	300	Aluminio	8424450266472
67110100221501	FF9622-S20AL300	96	2200K	ON/OFF	S20	300	Aluminio	8424450266489
67110100221601	FF9622-S40AL300	96	2200K	ON/OFF	S40	300	Aluminio	8424450266496
67110100300401	FF9630-S60AL300	96	3000K	ON/OFF	S60	300	Aluminio	8424450266533
67110100301501	FF9630-S20AL300	96	3000K	ON/OFF	S20	300	Aluminio	8424450266540
67110100301601	FF9630-S40AL300	96	3000K	ON/OFF	S40	300	Aluminio	8424450266557
67110100400401	FF9640-S60AL300	96	4000K	ON/OFF	S60	300	Aluminio	8424450266564
67110100401501	FF9640-S20AL300	96	4000K	ON/OFF	S20	300	Aluminio	8424450266571
67110100401601	FF9640-S40AL300	96	4000K	ON/OFF	S40	300	Aluminio	8424450266588
67110100500401	FF9650-S60AL300	96	5000K	ON/OFF	S60	300	Aluminio	8424450266595
67110100501501	FF9650-S20AL300	96	5000K	ON/OFF	S20	300	Aluminio	8424450266601
67110100501601	FF9650-S40AL300	96	5000K	ON/OFF	S40	300	Aluminio	8424450266618
67110200220401	FF19222-S60AL500	192	2200K	ON/OFF	S60	500	Aluminio	8424450268100
67110200221501	FF19222-S20AL500	192	2200K	ON/OFF	S20	500	Aluminio	8424450268117
67110200221601	FF19222-S40AL500	192	2200K	ON/OFF	S40	500	Aluminio	8424450268124
67110200300401	FF19230-S60AL500	192	3000K	ON/OFF	S60	500	Aluminio	8424450268162
67110200301501	FF19230-S20AL500	192	3000K	ON/OFF	S20	500	Aluminio	8424450268179
67110200301601	FF19230-S40AL500	192	3000K	ON/OFF	S40	500	Aluminio	8424450268186
67110200400401	FF19240-S60AL500	192	4000K	ON/OFF	S60	500	Aluminio	8424450268193
67110200401501	FF19240-S20AL500	192	4000K	ON/OFF	S20	500	Aluminio	8424450268209
67110200401601	FF19240-S40AL500	192	4000K	ON/OFF	S40	500	Aluminio	8424450268216
67110200500401	FF19250-S60AL500	192	5000K	ON/OFF	S60	500	Aluminio	8424450268223
67110200501501	FF19250-S20AL500	192	5000K	ON/OFF	S20	500	Aluminio	8424450268230
67110200501601	FF19250-S40AL500	192	5000K	ON/OFF	S40	500	Aluminio	8424450268247
67110300220401	FF19222-S60AL600	192	2200K	ON/OFF	S60	600	Aluminio	8424450268285
67110300221501	FF19222-S20AL600	192	2200K	ON/OFF	S20	600	Aluminio	8424450268292
67110300221601	FF19222-S40AL600	192	2200K	ON/OFF	S40	600	Aluminio	8424450268308
67110300300401	FF19230-S60AL600	192	3000K	ON/OFF	S60	600	Aluminio	8424450268346
67110300301501	FF19230-S20AL600	192	3000K	ON/OFF	S20	600	Aluminio	8424450268353

PROYECTORES

ZONAS DEPORTIVAS Y GRANDES ÁREAS





REF. PEDIDO	REF. LÓGICA	Nº LEDs	💡	CONTROL	TIPO DE ÓPTICA	POTENCIA (W)	🔧	EAN13
Proyector Flex								
67110300301601	FF19230-S40AL600	192	3000K	ON/OFF	S40	600	Aluminio	8424450268360
67110300400401	FF19240-S60AL600	192	4000K	ON/OFF	S60	600	Aluminio	8424450268377
67110300401501	FF19240-S20AL600	192	4000K	ON/OFF	S20	600	Aluminio	8424450268384
67110300401601	FF19240-S40AL600	192	4000K	ON/OFF	S40	600	Aluminio	8424450268391
67110300500401	FF19250-S60AL600	192	5000K	ON/OFF	S60	600	Aluminio	8424450268407
67110300501501	FF19250-S20AL600	192	5000K	ON/OFF	S20	600	Aluminio	8424450268414
67110300501601	FF19250-S40AL600	192	5000K	ON/OFF	S40	600	Aluminio	8424450268421
67110400220401	FF28822-S60AL750	288	2200K	ON/OFF	S60	750	Aluminio	8424450268469
67110400221501	FF28822-S20AL750	288	2200K	ON/OFF	S20	750	Aluminio	8424450268476
67110400221601	FF28822-S40AL750	288	2200K	ON/OFF	S40	750	Aluminio	8424450268483
67110400300401	FF28830-S60AL750	288	3000K	ON/OFF	S60	750	Aluminio	8424450268520
67110400301501	FF28830-S20AL750	288	3000K	ON/OFF	S20	750	Aluminio	8424450268537
67110400301601	FF28830-S40AL750	288	3000K	ON/OFF	S40	750	Aluminio	8424450268544
67110400400401	FF28840-S60AL750	288	4000K	ON/OFF	S60	750	Aluminio	8424450268551
67110400401501	FF28840-S20AL750	288	4000K	ON/OFF	S20	750	Aluminio	8424450268568
67110400401601	FF28840-S40AL750	288	4000K	ON/OFF	S40	750	Aluminio	8424450268575
67110400500401	FF28850-S60AL750	288	5000K	ON/OFF	S60	750	Aluminio	8424450268582
67110400501501	FF28850-S20AL750	288	5000K	ON/OFF	S20	750	Aluminio	8424450268599
67110400501601	FF28850-S40AL750	288	5000K	ON/OFF	S40	750	Aluminio	8424450268605
67110500220401	FF28822-S60AL900	288	2200K	ON/OFF	S60	900	Aluminio	8424450268643
67110500221501	FF28822-S20AL900	288	2200K	ON/OFF	S20	900	Aluminio	8424450268650
67110500221601	FF28822-S40AL900	288	2200K	ON/OFF	S40	900	Aluminio	8424450268667
67110500300401	FF28830-S60AL900	288	3000K	ON/OFF	S60	900	Aluminio	8424450268704
67110500301501	FF28830-S20AL900	288	3000K	ON/OFF	S20	900	Aluminio	8424450268711
67110500301601	FF28830-S40AL900	288	3000K	ON/OFF	S40	900	Aluminio	8424450268728
67110500400401	FF28840-S60AL900	288	4000K	ON/OFF	S60	900	Aluminio	8424450268735
67110500401501	FF28840-S20AL900	288	4000K	ON/OFF	S20	900	Aluminio	8424450268742
67110500401601	FF28840-S40AL900	288	4000K	ON/OFF	S40	900	Aluminio	8424450268759
67110500500401	FF28850-S60AL900	288	5000K	ON/OFF	S60	900	Aluminio	8424450268766
67110500501501	FF28850-S20AL900	288	5000K	ON/OFF	S20	900	Aluminio	8424450268773
67110500501601	FF28850-S40AL900	288	5000K	ON/OFF	S40	900	Aluminio	8424450268780
67110600220401	FF38422-S60AL1000	384	2200K	ON/OFF	S60	1000	Aluminio	8424450268827
67110600221501	FF38422-S20AL1000	384	2200K	ON/OFF	S20	1000	Aluminio	8424450268834
67110600221601	FF38422-S40AL1000	384	2200K	ON/OFF	S40	1000	Aluminio	8424450268841
67110600300401	FF38430-S60AL1000	384	3000K	ON/OFF	S60	1000	Aluminio	8424450268889
67110600301501	FF38430-S20AL1000	384	3000K	ON/OFF	S20	1000	Aluminio	8424450268896
67110600301601	FF38430-S40AL1000	384	3000K	ON/OFF	S40	1000	Aluminio	8424450268902
67110600400401	FF38440-S60AL1000	384	4000K	ON/OFF	S60	1000	Aluminio	8424450268919
67110600401501	FF38440-S20AL1000	384	4000K	ON/OFF	S20	1000	Aluminio	8424450268926
67110600401601	FF38440-S40AL1000	384	4000K	ON/OFF	S40	1000	Aluminio	8424450268933
67110600500401	FF38450-S60AL1000	384	5000K	ON/OFF	S60	1000	Aluminio	8424450268940
67110600501501	FF38450-S20AL1000	384	5000K	ON/OFF	S20	1000	Aluminio	8424450268957
67110600501601	FF38450-S40AL1000	384	5000K	ON/OFF	S40	1000	Aluminio	8424450268964
67110700220401	FF38422-S60AL1200	384	2200K	ON/OFF	S60	1200	Aluminio	8424450269008
67110700221501	FF38422-S20AL1200	384	2200K	ON/OFF	S20	1200	Aluminio	8424450269015
67110700221601	FF38422-S40AL1200	384	2200K	ON/OFF	S40	1200	Aluminio	8424450269022
67110700300401	FF38430-S60AL1200	384	3000K	ON/OFF	S60	1200	Aluminio	8424450269060
67110700301501	FF38430-S20AL1200	384	3000K	ON/OFF	S20	1200	Aluminio	8424450269077
67110700301601	FF38430-S40AL1200	384	3000K	ON/OFF	S40	1200	Aluminio	8424450269084
67110700400401	FF38440-S60AL1200	384	4000K	ON/OFF	S60	1200	Aluminio	8424450269091
67110700401501	FF38440-S20AL1200	384	4000K	ON/OFF	S20	1200	Aluminio	8424450269107
67110700401601	FF38440-S40AL1200	384	4000K	ON/OFF	S40	1200	Aluminio	8424450269114
67110700500401	FF38450-S60AL1200	384	5000K	ON/OFF	S60	1200	Aluminio	8424450269121
67110700501501	FF38450-S20AL1200	384	5000K	ON/OFF	S20	1200	Aluminio	8424450269138
67110700501601	FF38450-S40AL1200	384	5000K	ON/OFF	S40	1200	Aluminio	8424450269145



PROYECTORES



ZONAS DEPORTIVAS Y GRANDES ÁREAS

REF. PEDIDO	REF. LÓGICA	Nº LEDs		CONTROL	TIPO DE ÓPTICA	POTENCIA (W)		EAN13
Proyector Maxi								
67310000180301	FM4818-S90AL150	48	PC Ámbar	ON/OFF	S90	150	Aluminio	8424450260951
67310000180401	FM4818-S60AL150	48	PC Ámbar	ON/OFF	S60	150	Aluminio	8424450260968
67310000180901	FM4818-APZAL150	48	PC Ámbar	ON/OFF	APZ	150	Aluminio	8424450260975
67310000181001	FM4818-S30AL150	48	PC Ámbar	ON/OFF	S30	150	Aluminio	8424450260982
67310000220301	FM4822-S90AL150	48	2200K	ON/OFF	S90	150	Aluminio	8424450237618
67310000220401	FM4822-S60AL150	48	2200K	ON/OFF	S60	150	Aluminio	8424450260906
67310000220901	FM4822-APZAL150	48	2200K	ON/OFF	APZ	150	Aluminio	8424450255735
67310000221001	FM4822-S30AL150	48	2200K	ON/OFF	S30	150	Aluminio	8424450260913
67310000300301	FM4830-S90AL150	48	3000K	ON/OFF	S90	150	Aluminio	8424450209653
67310000300401	FM4830-S60AL150	48	3000K	ON/OFF	S60	150	Aluminio	8424450260920
67310000300901	FM4830-APZAL150	48	3000K	ON/OFF	APZ	150	Aluminio	8424450260937
67310000301001	FM4830-S30AL150	48	3000K	ON/OFF	S30	150	Aluminio	8424450260944
67310000400301	FM4840-S90AL150	48	4000K	ON/OFF	S90	150	Aluminio	8424450204542
67310000400401	FM4840-S60AL150	48	4000K	ON/OFF	S60	150	Aluminio	8424450205334
67310000400901	FM4840-APZAL150	48	4000K	ON/OFF	APZ	150	Aluminio	8424450216699
67310000401001	FM4840-S30AL150	48	4000K	ON/OFF	S30	150	Aluminio	8424450216705
67310000500301	FM4850-S90AL150	48	5000K	ON/OFF	S90	150	Aluminio	8424450201268
67310000500401	FM4850-S60AL150	48	5000K	ON/OFF	S60	150	Aluminio	8424450205341
67310000500901	FM4850-APZAL150	48	5000K	ON/OFF	APZ	150	Aluminio	8424450216712
67310000501001	FM4850-S30AL150	48	5000K	ON/OFF	S30	150	Aluminio	8424450212486
67510000180301	FM7218-S90AL196	72	PC Ámbar	ON/OFF	S90	196	Aluminio	8424450261040
67510000180401	FM7218-S60AL196	72	PC Ámbar	ON/OFF	S60	196	Aluminio	8424450261057
67510000180901	FM7218-APZAL196	72	PC Ámbar	ON/OFF	APZ	196	Aluminio	8424450261064
67510000181001	FM7218-S30AL196	72	PC Ámbar	ON/OFF	S30	196	Aluminio	8424450261071
67510000220301	FM7222-S90AL196	72	2200K	ON/OFF	S90	196	Aluminio	8424450237601
67510000220401	FM7222-S60AL196	72	2200K	ON/OFF	S60	196	Aluminio	8424450260999
67510000220901	FM7222-APZAL196	72	2200K	ON/OFF	APZ	196	Aluminio	8424450261002
67510000221001	FM7222-S30AL196	72	2200K	ON/OFF	S30	196	Aluminio	8424450261019
67510000300301	FM7230-S90AL196	72	3000K	ON/OFF	S90	196	Aluminio	8424450209660
67510000300401	FM7230-S60AL196	72	3000K	ON/OFF	S60	196	Aluminio	8424450261026
67510000300901	FM7230-APZAL196	72	3000K	ON/OFF	APZ	196	Aluminio	8424450261033
67510000301001	FM7230-S30AL196	72	3000K	ON/OFF	S30	196	Aluminio	8424450219546
67510000400301	FM7240-S90AL196	72	4000K	ON/OFF	S90	196	Aluminio	8424450204559
67510000400401	FM7240-S60AL196	72	4000K	ON/OFF	S60	196	Aluminio	8424450205310
67510000400901	FM7240-APZAL196	72	4000K	ON/OFF	APZ	196	Aluminio	8424450213629
67510000401001	FM7240-S30AL196	72	4000K	ON/OFF	S30	196	Aluminio	8424450212318
67510000500301	FM7250-S90AL196	72	5000K	ON/OFF	S90	196	Aluminio	8424450201282
67510000500401	FM7250-S60AL196	72	5000K	ON/OFF	S60	196	Aluminio	8424450205327
67510000500901	FM7250-APZAL196	72	5000K	ON/OFF	APZ	196	Aluminio	8424450216729
67510000501001	FM7250-S30AL196	72	5000K	ON/OFF	S30	196	Aluminio	8424450216736



PROYECTORES

ILUMINACIÓN ARQUITECTÓNICA Y ARTÍSTICA

REF. PEDIDO	REF. LÓGICA	Nº LEDs		CONTROL	TIPO DE ÓPTICA	POTENCIA (W)		EAN13
Proyector Estándar								
6710000180301	FL2418-S90AL58	24	PC Ámbar	ON/OFF	S90	58	Aluminio	8424450260579
6710000180401	FL2418-S60AL58	24	PC Ámbar	ON/OFF	S60	58	Aluminio	8424450260586
6710000180901	FL2418-APZAL58	24	PC Ámbar	ON/OFF	APZ	58	Aluminio	8424450260593
6710000181001	FL2418-S30AL58	24	PC Ámbar	ON/OFF	S30	58	Aluminio	8424450260609
6710000220301	FL2422-S90AL58	24	2200K	ON/OFF	S90	58	Aluminio	8424450251317
6710000220401	FL2422-S60AL58	24	2200K	ON/OFF	S60	58	Aluminio	8424450260517
6710000220901	FL2422-APZAL58	24	2200K	ON/OFF	APZ	58	Aluminio	8424450260524
6710000221001	FL2422-S30AL58	24	2200K	ON/OFF	S30	58	Aluminio	8424450260531
6710000300301	FL2430-S90AL58	24	3000K	ON/OFF	S90	58	Aluminio	8424450219904
6710000300401	FL2430-S60AL58	24	3000K	ON/OFF	S60	58	Aluminio	8424450260548
6710000300901	FL2430-APZAL58	24	3000K	ON/OFF	APZ	58	Aluminio	8424450260555
6710000301001	FL2430-S30AL58	24	3000K	ON/OFF	S30	58	Aluminio	8424450260562
6710000400301	FL2440-S90AL58	24	4000K	ON/OFF	S90	58	Aluminio	8424450216491
6710000400401	FL2440-S60AL58	24	4000K	ON/OFF	S60	58	Aluminio	8424450214817
6710000400901	FL2440-APZAL58	24	4000K	ON/OFF	APZ	58	Aluminio	8424450212103
6710000401001	FL2440-S30AL58	24	4000K	ON/OFF	S30	58	Aluminio	8424450216507
6710000500301	FL2450-S90AL58	24	5000K	ON/OFF	S90	58	Aluminio	8424450201220
6710000500401	FL2450-S60AL58	24	5000K	ON/OFF	S60	58	Aluminio	8424450216514
6710000500901	FL2450-APZAL58	24	5000K	ON/OFF	APZ	58	Aluminio	8424450216521
6710000501001	FL2450-S30AL58	24	5000K	ON/OFF	S30	58	Aluminio	8424450216538
67100001180301	FL2418D-S90AL58	24	PC Ámbar	Dimming	S90	58	Aluminio	8424450260678
67100001180401	FL2418D-S60AL58	24	PC Ámbar	Dimming	S60	58	Aluminio	8424450260685
67100001180901	FL2418D-APZAL58	24	PC Ámbar	Dimming	APZ	58	Aluminio	8424450260692
67100001181001	FL2418D-S30AL58	24	PC Ámbar	Dimming	S30	58	Aluminio	8424450260708
67100001220301	FL2422D-S90AL58	24	2200K	Dimming	S90	58	Aluminio	8424450260616
67100001220401	FL2422D-S60AL58	24	2200K	Dimming	S60	58	Aluminio	8424450260623
67100001220901	FL2422D-APZAL58	24	2200K	Dimming	APZ	58	Aluminio	8424450260630
67100001221001	FL2422D-S30AL58	24	2200K	Dimming	S30	58	Aluminio	8424450260647
67100001300301	FL2430D-S90AL58	24	3000K	Dimming	S90	58	Aluminio	8424450250686
67100001300401	FL2430D-S60AL58	24	3000K	Dimming	S60	58	Aluminio	8424450260654
67100001300901	FL2430D-APZAL58	24	3000K	Dimming	APZ	58	Aluminio	8424450224106
67100001301001	FL2430D-S30AL58	24	3000K	Dimming	S30	58	Aluminio	8424450260661
67100001400301	FL2440D-S90AL58	24	4000K	Dimming	S90	58	Aluminio	8424450216415
67100001400401	FL2440D-S60AL58	24	4000K	Dimming	S60	58	Aluminio	8424450216422
67100001400901	FL2440D-APZAL58	24	4000K	Dimming	APZ	58	Aluminio	8424450216439
67100001401001	FL2440D-S30AL58	24	4000K	Dimming	S30	58	Aluminio	8424450216446
67100001500301	FL2450D-S90AL58	24	5000K	Dimming	S90	58	Aluminio	8424450216453
67100001500401	FL2450D-S60AL58	24	5000K	Dimming	S60	58	Aluminio	8424450216460
67100001500901	FL2450D-APZAL58	24	5000K	Dimming	APZ	58	Aluminio	8424450216477
67100001501001	FL2450D-S30AL58	24	5000K	Dimming	S30	58	Aluminio	8424450216484
67300000180301	FL4818-S90AL108	48	PC Ámbar	ON/OFF	S90	108	Aluminio	8424450260777
67300000180401	FL4818-S60AL108	48	PC Ámbar	ON/OFF	S60	108	Aluminio	8424450260784
67300000180901	FL4818-APZAL108	48	PC Ámbar	ON/OFF	APZ	108	Aluminio	8424450251003
67300000181001	FL4818-S30AL108	48	PC Ámbar	ON/OFF	S30	108	Aluminio	8424450260791
67300000220301	FL4822-S90AL108	48	2200K	ON/OFF	S90	108	Aluminio	8424450237625
67300000220401	FL4822-S60AL108	48	2200K	ON/OFF	S60	108	Aluminio	8424450260715
67300000220901	FL4822-APZAL108	48	2200K	ON/OFF	APZ	108	Aluminio	8424450260722
67300000221001	FL4822-S30AL108	48	2200K	ON/OFF	S30	108	Aluminio	8424450260739
67300000300301	FL4830-S60AL108	48	3000K	ON/OFF	S90	108	Aluminio	8424450246641
67300000300401	FL4830-S60AL108	48	3000K	ON/OFF	S60	108	Aluminio	8424450260746
67300000300901	FL4830-APZAL108	48	3000K	ON/OFF	APZ	108	Aluminio	8424450260753
67300000301001	FL4830-S30AL108	48	3000K	ON/OFF	S30	108	Aluminio	8424450260760
67300000400301	FL4840-S90AL108	48	4000K	ON/OFF	S90	108	Aluminio	8424450216620
67300000400401	FL4840-S60AL108	48	4000K	ON/OFF	S60	108	Aluminio	8424450216637
67300000400901	FL4840-APZAL108	48	4000K	ON/OFF	APZ	108	Aluminio	8424450216644
67300000401001	FL4840-S30AL108	48	4000K	ON/OFF	S30	108	Aluminio	8424450216651

ILUMINACIÓN ARQUITECTÓNICA Y ARTÍSTICA



REF. PEDIDO	REF. LÓGICA	Nº LEDs		CONTROL	TIPO DE ÓPTICA	POTENCIA (W)		EAN13
Proyector Estándar								
6730000500301	FL4850-S90AL108	48	5000K	ON/OFF	S90	108	Aluminio	8424450201244
6730000500401	FL4850-S60AL108	48	5000K	ON/OFF	S60	108	Aluminio	8424450216668
6730000500901	FL4850-APZAL108	48	5000K	ON/OFF	APZ	108	Aluminio	8424450216675
6730000501001	FL4850-S30AL108	48	5000K	ON/OFF	S30	108	Aluminio	8424450216682
67300001180301	FL4818D-S90AL108	48	PC Ámbar	Dimming	S90	108	Aluminio	8424450260869
67300001180401	FL4818D-S60AL108	48	PC Ámbar	Dimming	S60	108	Aluminio	8424450260876
67300001180901	FL4818D-APZAL108	48	PC Ámbar	Dimming	APZ	108	Aluminio	8424450260883
67300001181001	FL4818D-S30AL108	48	PC Ámbar	Dimming	S30	108	Aluminio	8424450260890
67300001220301	FL4822D-S90AL108	48	2200K	Dimming	S90	108	Aluminio	8424450260807
67300001220401	FL4822D-S60AL108	48	2200K	Dimming	S60	108	Aluminio	8424450260814
67300001220901	FL4822D-APZAL108	48	2200K	Dimming	APZ	108	Aluminio	8424450260821
67300001221001	FL4822D-S30AL108	48	2200K	Dimming	S30	108	Aluminio	8424450260838
67300001300301	FL4830D-S90AL108	48	3000K	Dimming	S90	108	Aluminio	8424450260845
67300001300401	FL4830D-S60AL108	48	3000K	Dimming	S60	108	Aluminio	8424450250921
67300001300901	FL4830D-APZAL108	48	3000K	Dimming	APZ	108	Aluminio	8424450238189
67300001301001	FL4830D-S30AL108	48	3000K	Dimming	S30	108	Aluminio	8424450260852
67300001400301	FL4840D-S90AL108	48	4000K	Dimming	S90	108	Aluminio	8424450216545
67300001400401	FL4840D-S60AL108	48	4000K	Dimming	S60	108	Aluminio	8424450216552
67300001400901	FL4840D-APZAL108	48	4000K	Dimming	APZ	108	Aluminio	8424450216569
67300001401001	FL4840D-S30AL108	48	4000K	Dimming	S30	108	Aluminio	8424450216576
67300001500301	FL4850D-S90AL108	48	5000K	Dimming	S90	108	Aluminio	8424450216583
67300001500401	FL4850D-S60AL108	48	5000K	Dimming	S60	108	Aluminio	8424450216590
67300001500901	FL4850D-APZAL108	48	5000K	Dimming	APZ	108	Aluminio	8424450216606
67300001501001	FL4850D-S30AL108	48	5000K	Dimming	S30	108	Aluminio	8424450216613

REF. PEDIDO	REF. LÓGICA	DESCRIPCIÓN		EAN13
690101	ISE	Soporte de Empotrar para Proyector Maxi e InnerLED, Acero Galvanizado		8424450191958
69030101	MFWS48AL	Soporte de Pared para Proyector Maxi e InnerLED 48 LED, Acero Lacado		8424450205587
69030201	MFWS72AL	Soporte de Pared para Proyector Maxi e InnerLED 72 LED, Acero Lacado		8424450205594
69030301	MFCS48AL	Soporte de Cruceta para Proyector Maxi 48 LED, Acero Lacado		8424450205600
69030401	MFCS72AL	Soporte de Cruceta para Proyector Maxi 72 LED, Acero Lacado		8424450205617
690306	T360S4MF72G	Soporte de Torre 360 G.C. para 4 Proyectores Maxi	Gris	8424450255742
690307	T450S4MF72G	Soporte de Torre 450 G.C. para 4 Proyectores Maxi	Gris	8424450255759
690308	T450S6MF72G	Soporte de Torre 450 G.C. para 6 Proyectores Maxi	Gris	8424450255766

*Disponibles Torres 360 y 450. Más información en la web.



▲ 69030101
69030201



▲ 69030301
69030401



BALIZAS

AROUSA

REF. PEDIDO	REF. LÓGICA	Nº LEDs		CONTROL	TIPO DE ÓPTICA	POTENCIA (W)		EAN13
Modelo alto (L)								
70001000180205	ABL1218-SPXM24	12	PC Ámbar	ON/OFF	SP	24	Inox Mate	8424450260500
70001000220205	ABL1222-SPXM24	12	2200K	ON/OFF	SP	24	Inox Mate	8424450229958
70001000300205	ABL1230-SPXM24	12	3000K	ON/OFF	SP	24	Inox Mate	8424450229125
70001000400205	ABL1240-SPXM24	12	4000K	ON/OFF	SP	24	Inox Mate	8424450229972

REF. PEDIDO	REF. LÓGICA	Nº LEDs		CONTROL	TIPO DE ÓPTICA	POTENCIA (W)		EAN13
Modelo bajo (S)								
70000000180205	ABS1218-SPXM15	12	PC Ámbar	ON/OFF	SP	15	Inox Mate	8424450260494
70000000220205	ABS1222-SPXM15	12	2200K	ON/OFF	SP	15	Inox Mate	8424450229910
70000000300205	ABS1230-SPXM15	12	3000K	ON/OFF	SP	15	Inox Mate	8424450229378
70000000400205	ABS1240-SPXM15	12	4000K	ON/OFF	SP	15	Inox Mate	8424450229934





▲ Modelo alto (L)

▲ Modelo bajo (S)



INNERLED

REF. PEDIDO	REF. LÓGICA	Nº LEDs		CONTROL	TIPO DE ÓPTICA	POTENCIA (W)		EAN13
InnerLED								
62350000300301	IN4830-S90AL80	48	3000K	ON/OFF	S90	80	Aluminio	8424450215555
62350000300401	IN4830-S60AL80	48	3000K	ON/OFF	S60	80	Aluminio	8424450215562
62350000301001	IN4830-S30AL80	48	3000K	ON/OFF	S30	80	Aluminio	8424450261149
62350000400301	IN4840-S90AL80	48	4000K	ON/OFF	S90	80	Aluminio	8424450200971
62350000400401	IN4840-S60AL80	48	4000K	ON/OFF	S60	80	Aluminio	8424450200988
62350000401001	IN4840-S30AL80	48	4000K	ON/OFF	S30	80	Aluminio	8424450261156
62350000500301	IN4850-S90AL80	48	5000K	ON/OFF	S90	80	Aluminio	8424450215579
62350000500401	IN4850-S60AL80	48	5000K	ON/OFF	S60	80	Aluminio	8424450206287
62350000501001	IN4850-S30AL80	48	5000K	ON/OFF	S30	80	Aluminio	8424450261163
62550000300301	IN7230-S90AL130	72	3000K	ON/OFF	S90	130	Aluminio	8424450215296
62550000300401	IN7230-S60AL130	72	3000K	ON/OFF	S60	130	Aluminio	8424450215586
62550000301001	IN7230-S30AL130	72	3000K	ON/OFF	S30	130	Aluminio	8424450261170
62550000400301	IN7240-S90AL130	72	4000K	ON/OFF	S90	130	Aluminio	8424450200995
62550000400401	IN7240-S60AL130	72	4000K	ON/OFF	S60	130	Aluminio	8424450201008
62550000401001	IN7240-S30AL130	72	4000K	ON/OFF	S30	130	Aluminio	8424450261187
62550000500301	IN7250-S90AL130	72	5000K	ON/OFF	S90	130	Aluminio	8424450201176
62550000500401	IN7250-S60AL130	72	5000K	ON/OFF	S60	130	Aluminio	8424450215593
62550000501001	IN7250-S30AL130	72	5000K	ON/OFF	S30	130	Aluminio	8424450261194
62750000300301	IN9630-S90AL200	96	3000K	ON/OFF	S90	200	Aluminio	8424450215609
62750000300401	IN9630-S60AL200	96	3000K	ON/OFF	S60	200	Aluminio	8424450215616
62750000301001	IN9630-S30AL200	96	3000K	ON/OFF	S30	200	Aluminio	8424450261200
62750000400301	IN9640-S90AL200	96	4000K	ON/OFF	S90	200	Aluminio	8424450201015
62750000400401	IN9640-S60AL200	96	4000K	ON/OFF	S60	200	Aluminio	8424450201022
62750000401001	IN9640-S30AL200	96	4000K	ON/OFF	S30	200	Aluminio	8424450261217
62750000500301	IN9650-S90AL200	96	5000K	ON/OFF	S90	200	Aluminio	8424450201183
62750000500401	IN9650-S60AL200	96	5000K	ON/OFF	S60	200	Aluminio	8424450215623
62750000501001	IN9650-S30AL200	96	5000K	ON/OFF	S30	200	Aluminio	8424450261224





ALUMBRADO INTERIOR INDUSTRIAL

CAMPANA ZAR (UFO)

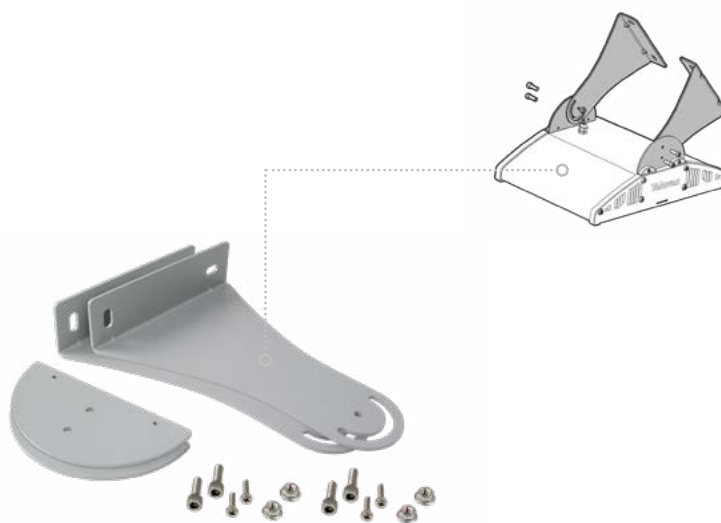

REF. PEDIDO	REF. LÓGICA	Nº LEDs	💡	CONTROL	TIPO DE ÓPTICA	POTENCIA (W)	🖨️	EAN13
Campaña ZAR (UFO)								
6210000400302	ZA25240-S90BL150	252	4000K	ON/OFF	S90	150	Negro	8424450246221
6210000400402	ZA25240-S60BL150	252	4000K	ON/OFF	S60	150	Negro	8424450246238
6210000401402	ZA25240-S120BL150	252	4000K	ON/OFF	S120	150	Negro	8424450246245
6210000500302	ZA25250-S90BL150	252	5000K	ON/OFF	S90	150	Negro	8424450246252
6210000500402	ZA25250-S60BL150	252	5000K	ON/OFF	S60	150	Negro	8424450246269
6210000501402	ZA25250-S120BL150	252	5000K	ON/OFF	S120	150	Negro	8424450246276
62101000400302	ZA25240-S90BL200	252	4000K	ON/OFF	S90	200	Negro	8424450246283
62101000400402	ZA25240-S60BL200	252	4000K	ON/OFF	S60	200	Negro	8424450246290
62101000401402	ZA25240-S120BL200	252	4000K	ON/OFF	S120	200	Negro	8424450246306
62101000500302	ZA25250-S90BL200	252	5000K	ON/OFF	S90	200	Negro	8424450246313
62101000500402	ZA25250-S60BL200	252	5000K	ON/OFF	S60	200	Negro	8424450246320
62101000501402	ZA25250-S120BL200	252	5000K	ON/OFF	S120	200	Negro	8424450246337

REF. PEDIDO	REF. LÓGICA	DESCRIPCIÓN	EAN13
Accesorios			
690101	ISE	Soporte de Empotrar para Proyector Maxi e InnerLED, Acero Galvanizado	8424450191958
69030101	MFWS48AL	Soporte de Pared para Proyector Maxi e InnerLED 48 LED, Acero Lacado	8424450205587
69030201	MFWS72AL	Soporte de Pared para Proyector Maxi e InnerLED 72 LED, Acero Lacado	8424450205594



▲ 690101

COMPONENTE RETROFIT



REF. PEDIDO	REF. LÓGICA	Nº LEDs	💡	CONTROL	TIPO DE ÓPTICA	POTENCIA (W)	🖨️	EAN13
Componente Retrofit								
63050000180101	RE1218-PBL29	12	PC Ámbar	ON/OFF	P	29	Negro	8424450261323
63050000180201	RE1218-SPBL29	12	PC Ámbar	ON/OFF	SP	29	Negro	8424450261330
63050000180601	RE1218-T2BL29	12	PC Ámbar	ON/OFF	T2	29	Negro	8424450261347
63050000180701	RE1218-MEBL29	12	PC Ámbar	ON/OFF	ME	29	Negro	8424450261354
63050000180801	RE1218-T3BL29	12	PC Ámbar	ON/OFF	T3	29	Negro	8424450261361
63050000180901	RE1218-APZBL29	12	PC Ámbar	ON/OFF	APZ	29	Negro	8424450261378
63050000181301	RE1218-SCLBL29	12	PC Ámbar	ON/OFF	SCL	29	Negro	8424450261385
63050000220101	RE1222-PBL29	12	2200K	ON/OFF	P	29	Negro	8424450247792
63050000220201	RE1222-SPBL29	12	2200K	ON/OFF	SP	29	Negro	8424450213919
63050000220601	RE1222-T2BL29	12	2200K	ON/OFF	T2	29	Negro	8424450247808
63050000220701	RE1222-MEBL29	12	2200K	ON/OFF	ME	29	Negro	8424450247815
63050000220801	RE1222-T3BL29	12	2200K	ON/OFF	T3	29	Negro	8424450247822
63050000220901	RE1222-APZBL29	12	2200K	ON/OFF	APZ	29	Negro	8424450247839
63050000221301	RE1222-SCLBL29	12	2200K	ON/OFF	SCL	29	Negro	8424450247846
63050000300101	RE1230-PBL29	12	3000K	ON/OFF	P	29	Negro	8424450200414
63050000300201	RE1230-SPBL29	12	3000K	ON/OFF	SP	29	Negro	8424450200421
63050000300601	RE1230-T2BL29	12	3000K	ON/OFF	T2	29	Negro	8424450261392
63050000300701	RE1230-MEBL29	12	3000K	ON/OFF	ME	29	Negro	8424450261408
63050000300801	RE1230-T3BL29	12	3000K	ON/OFF	T3	29	Negro	8424450261415
63050000300901	RE1230-APZBL29	12	3000K	ON/OFF	APZ	29	Negro	8424450261422
63050000301301	RE1230-SCLBL29	12	3000K	ON/OFF	SCL	29	Negro	8424450261439
63050000400101	RE1240-PBL29	12	4000K	ON/OFF	P	29	Negro	8424450200452
63050000400201	RE1240-SPBL29	12	4000K	ON/OFF	SP	29	Negro	8424450200445
63050000400601	RE1240-T2BL29	12	4000K	ON/OFF	T2	29	Negro	8424450251737
63050000400701	RE1240-MEBL29	12	4000K	ON/OFF	ME	29	Negro	8424450261446
63050000400801	RE1240-T3BL29	12	4000K	ON/OFF	T3	29	Negro	8424450261453
63050000400901	RE1240-APZBL29	12	4000K	ON/OFF	APZ	29	Negro	8424450261460
63050000401301	RE1240-SCLBL29	12	4000K	ON/OFF	SCL	29	Negro	8424450261477
63050001180101	RE1218D-PBL29	12	PC Ámbar	Dimming	P	29	Negro	8424450261484
63050001180201	RE1218D-SPBL29	12	PC Ámbar	Dimming	SP	29	Negro	8424450261491
63050001180601	RE1218D-T2BL29	12	PC Ámbar	Dimming	T2	29	Negro	8424450261507
63050001180701	RE1218D-MEBL29	12	PC Ámbar	Dimming	ME	29	Negro	8424450261514
63050001180801	RE1218D-T3BL29	12	PC Ámbar	Dimming	T3	29	Negro	8424450261521
63050001180901	RE1218D-APZBL29	12	PC Ámbar	Dimming	APZ	29	Negro	8424450261538
63050001181301	RE1218D-SCLBL29	12	PC Ámbar	Dimming	SCL	29	Negro	8424450261545
63050001220101	RE1222D-PBL29	12	2200K	Dimming	P	29	Negro	8424450205532
63050001220201	RE1222D-SPBL29	12	2200K	Dimming	SP	29	Negro	8424450235355
63050001220601	RE1222D-T2BL29	12	2200K	Dimming	T2	29	Negro	8424450261552
63050001220701	RE1222D-MEBL29	12	2200K	Dimming	ME	29	Negro	8424450261569
63050001220801	RE1222D-T3BL29	12	2200K	Dimming	T3	29	Negro	8424450261576
63050001220901	RE1222D-APZBL29	12	2200K	Dimming	APZ	29	Negro	8424450261583
63050001221301	RE1222D-SCLBL29	12	2200K	Dimming	SCL	29	Negro	8424450261590
63050001300101	RE1230D-PBL29	12	3000K	Dimming	P	29	Negro	8424450200650
63050001300201	RE1230D-SPBL29	12	3000K	Dimming	SP	29	Negro	8424450201114
63050001300601	RE1230D-T2BL29	12	3000K	Dimming	T2	29	Negro	8424450261606
63050001300701	RE1230D-MEBL29	12	3000K	Dimming	ME	29	Negro	8424450261613
63050001300801	RE1230D-T3BL29	12	3000K	Dimming	T3	29	Negro	8424450261620
63050001300901	RE1230D-APZBL29	12	3000K	Dimming	APZ	29	Negro	8424450246924
63050001301301	RE1230D-SCLBL29	12	3000K	Dimming	SCL	29	Negro	8424450261637
63050001400101	RE1240D-PBL29	12	4000K	Dimming	P	29	Negro	8424450200490
63050001400201	RE1240D-SPBL29	12	4000K	Dimming	SP	29	Negro	8424450201121
63050001400601	RE1240D-T2BL29	12	4000K	Dimming	T2	29	Negro	8424450261644
63050001400701	RE1240D-MEBL29	12	4000K	Dimming	ME	29	Negro	8424450261651
63050001400801	RE1240D-T3BL29	12	4000K	Dimming	T3	29	Negro	8424450261668
63050001400901	RE1240D-APZBL29	12	4000K	Dimming	APZ	29	Negro	8424450212468
63050001401301	RE1240D-SCLBL29	12	4000K	Dimming	SCL	29	Negro	8424450261675

RENOVACIÓN DEL ALUMBRADO (RETROFIT)

COMPONENTE RETROFIT



REF. PEDIDO	REF. LÓGICA	Nº LEDs	💡	CONTROL	TIPO DE ÓPTICA	POTENCIA (W)	🖨️	EAN13
Componente Retrofit								
63051100180101	RE1218-PBL39	12	PC Ámbar	ON/OFF	P	39	Negro	8424450261682
63051100180201	RE1218-SPBL39	12	PC Ámbar	ON/OFF	SP	39	Negro	8424450261699
63051100180601	RE1218-T2BL39	12	PC Ámbar	ON/OFF	T2	39	Negro	8424450261705
63051100180701	RE1218-MEBL39	12	PC Ámbar	ON/OFF	ME	39	Negro	8424450261712
63051100180801	RE1218-T3BL39	12	PC Ámbar	ON/OFF	T3	39	Negro	8424450261729
63051100180901	RE1218-APZBL39	12	PC Ámbar	ON/OFF	APZ	39	Negro	8424450261736
63051100181301	RE1218-SCLBL39	12	PC Ámbar	ON/OFF	SCL	39	Negro	8424450261743
63051100220101	RE1222-PBL39	12	2200K	ON/OFF	P	39	Negro	8424450248065
63051100220201	RE1222-SPBL39	12	2200K	ON/OFF	SP	39	Negro	8424450215357
63051100220601	RE1222-T2BL39	12	2200K	ON/OFF	T2	39	Negro	8424450248072
63051100220701	RE1222-MEBL39	12	2200K	ON/OFF	ME	39	Negro	8424450248089
63051100220801	RE1222-T3BL39	12	2200K	ON/OFF	T3	39	Negro	8424450248096
63051100220901	RE1222-APZBL39	12	2200K	ON/OFF	APZ	39	Negro	8424450248102
63051100221301	RE1222-SCLBL39	12	2200K	ON/OFF	SCL	39	Negro	8424450248119
63051100300101	RE1230-PBL39	12	3000K	ON/OFF	P	39	Negro	8424450237960
63051100300201	RE1230-SPBL39	12	3000K	ON/OFF	SP	39	Negro	8424450214381
63051100300601	RE1230-T2BL39	12	3000K	ON/OFF	T2	39	Negro	8424450261750
63051100300701	RE1230-MEBL39	12	3000K	ON/OFF	ME	39	Negro	8424450261767
63051100300801	RE1230-T3BL39	12	3000K	ON/OFF	T3	39	Negro	8424450261774
63051100300901	RE1230-APZBL39	12	3000K	ON/OFF	APZ	39	Negro	8424450261781
63051100301301	RE1230-SCLBL39	12	3000K	ON/OFF	SCL	39	Negro	8424450261798
63051100400101	RE1240-PBL39	12	4000K	ON/OFF	P	39	Negro	8424450210994
63051100400201	RE1240-SPBL39	12	4000K	ON/OFF	SP	39	Negro	8424450210741
63051100400601	RE1240-T2BL39	12	4000K	ON/OFF	T2	39	Negro	8424450261804
63051100400701	RE1240-MEBL39	12	4000K	ON/OFF	ME	39	Negro	8424450261811
63051100400801	RE1240-T3BL39	12	4000K	ON/OFF	T3	39	Negro	8424450261828
63051100400901	RE1240-APZBL39	12	4000K	ON/OFF	APZ	39	Negro	8424450240243
63051100401301	RE1240-SCLBL39	12	4000K	ON/OFF	SCL	39	Negro	8424450261835
63051101180101	RE1218D-PBL39	12	PC Ámbar	Dimming	P	39	Negro	8424450261842
63051101180201	RE1218D-SPBL39	12	PC Ámbar	Dimming	SP	39	Negro	8424450261859
63051101180601	RE1218D-T2BL39	12	PC Ámbar	Dimming	T2	39	Negro	8424450261866
63051101180701	RE1218D-MEBL39	12	PC Ámbar	Dimming	ME	39	Negro	8424450261873
63051101180801	RE1218D-T3BL39	12	PC Ámbar	Dimming	T3	39	Negro	8424450261880
63051101180901	RE1218D-APZBL39	12	PC Ámbar	Dimming	APZ	39	Negro	8424450261897
63051101181301	RE1218D-SCLBL39	12	PC Ámbar	Dimming	SCL	39	Negro	8424450261903
63051101220101	RE1222D-PBL39	12	2200K	Dimming	P	39	Negro	8424450233061
63051101220201	RE1222D-SPBL39	12	2200K	Dimming	SP	39	Negro	8424450233054
63051101220601	RE1222D-T2BL39	12	2200K	Dimming	T2	39	Negro	8424450261910
63051101220701	RE1222D-MEBL39	12	2200K	Dimming	ME	39	Negro	8424450261927
63051101220801	RE1222D-T3BL39	12	2200K	Dimming	T3	39	Negro	8424450261934
63051101220901	RE1222D-APZBL39	12	2200K	Dimming	APZ	39	Negro	8424450261941
63051101221301	RE1222D-SCLBL39	12	2200K	Dimming	SCL	39	Negro	8424450261958
63051101300101	RE1230D-PBL39	12	3000K	Dimming	P	39	Negro	8424450248218
63051101300201	RE1230D-SPBL39	12	3000K	Dimming	SP	39	Negro	8424450211939
63051101300601	RE1230D-T2BL39	12	3000K	Dimming	T2	39	Negro	8424450261972
63051101300701	RE1230D-MEBL39	12	3000K	Dimming	ME	39	Negro	8424450261989
63051101300801	RE1230D-T3BL39	12	3000K	Dimming	T3	39	Negro	8424450261996
63051101300901	RE1230D-APZBL39	12	3000K	Dimming	APZ	39	Negro	8424450262009
63051101301301	RE1230D-SCLBL39	12	3000K	Dimming	SCL	39	Negro	8424450262016
63051101400101	RE1240D-PBL39	12	4000K	Dimming	P	39	Negro	8424450238226
63051101400201	RE1240D-SPBL39	12	4000K	Dimming	SP	39	Negro	8424450213537
63051101400601	RE1240D-T2BL39	12	4000K	Dimming	T2	39	Negro	8424450262023
63051101400701	RE1240D-MEBL39	12	4000K	Dimming	ME	39	Negro	8424450262030
63051101400801	RE1240D-T3BL39	12	4000K	Dimming	T3	39	Negro	8424450262047
63051101400901	RE1240D-APZBL39	12	4000K	Dimming	APZ	39	Negro	8424450262054
63051101401301	RE1240D-SCLBL39	12	4000K	Dimming	SCL	39	Negro	8424450262061

COMPONENTE RETROFIT



REF. PEDIDO	REF. LÓGICA	Nº LEDs		CONTROL	TIPO DE ÓPTICA	POTENCIA (W)		EAN13
Componente Retrofit								
63150000180101	RE2418-PBL53	24	PC Ámbar	ON/OFF	P	53	Negro	8424450263815
63150000180201	RE2418-SPBL53	24	PC Ámbar	ON/OFF	SP	53	Negro	8424450263822
63150000180601	RE2418-T2BL53	24	PC Ámbar	ON/OFF	T2	53	Negro	8424450263839
63150000180701	RE2418-MEBL53	24	PC Ámbar	ON/OFF	ME	53	Negro	8424450263846
63150000180801	RE2418-T3BL53	24	PC Ámbar	ON/OFF	T3	53	Negro	8424450263853
63150000180901	RE2418-APZBL53	24	PC Ámbar	ON/OFF	APZ	53	Negro	8424450263860
63150000181301	RE2418-SCLBL53	24	PC Ámbar	ON/OFF	SCL	53	Negro	8424450263877
63150000220101	RE2422-PBL53	24	2200K	ON/OFF	P	53	Negro	8424450209608
63150000220201	RE2422-SPBL53	24	2200K	ON/OFF	SP	53	Negro	8424450232408
63150000220601	RE2422-T2BL53	24	2200K	ON/OFF	T2	53	Negro	8424450249765
63150000220701	RE2422-MEBL53	24	2200K	ON/OFF	ME	53	Negro	8424450249772
63150000220801	RE2422-T3BL53	24	2200K	ON/OFF	T3	53	Negro	8424450249789
63150000220901	RE2422-APZBL53	24	2200K	ON/OFF	APZ	53	Negro	8424450249796
63150000221301	RE2422-SCLBL53	24	2200K	ON/OFF	SCL	53	Negro	8424450249802
63150000300101	RE2430-PBL53	24	3000K	ON/OFF	P	53	Negro	8424450200742
63150000300201	RE2430-SPBL53	24	3000K	ON/OFF	SP	53	Negro	8424450201145
63150000300601	RE2430-T2BL53	24	3000K	ON/OFF	T2	53	Negro	8424450263884
63150000300701	RE2430-MEBL53	24	3000K	ON/OFF	ME	53	Negro	8424450263891
63150000300801	RE2430-T3BL53	24	3000K	ON/OFF	T3	53	Negro	8424450210321
63150000300901	RE2430-APZBL53	24	3000K	ON/OFF	APZ	53	Negro	8424450263907
63150000301301	RE2430-SCLBL53	24	3000K	ON/OFF	SCL	53	Negro	8424450263914
63150000400101	RE2440-PBL53	24	4000K	ON/OFF	P	53	Negro	8424450200759
63150000400201	RE2440-SPBL53	24	4000K	ON/OFF	SP	53	Negro	8424450200773
63150000400601	RE2440-T2BL53	24	4000K	ON/OFF	T2	53	Negro	8424450263921
63150000400701	RE2440-MEBL53	24	4000K	ON/OFF	ME	53	Negro	8424450263938
63150000400801	RE2440-T3BL53	24	4000K	ON/OFF	T3	53	Negro	8424450263945
63150000400901	RE2440-APZBL53	24	4000K	ON/OFF	APZ	53	Negro	8424450212851
63150000401301	RE2440-SCLBL53	24	4000K	ON/OFF	SCL	53	Negro	8424450263952
63150001180101	RE2418D-PBL53	24	PC Ámbar	Dimming	P	53	Negro	8424450263969
63150001180201	RE2418D-SPBL53	24	PC Ámbar	Dimming	SP	53	Negro	8424450263976
63150001180601	RE2418D-T2BL53	24	PC Ámbar	Dimming	T2	53	Negro	8424450263983
63150001180701	RE2418D-MEBL53	24	PC Ámbar	Dimming	ME	53	Negro	8424450263990
63150001180801	RE2418D-T3BL53	24	PC Ámbar	Dimming	T3	53	Negro	8424450264003
63150001180901	RE2418D-APZBL53	24	PC Ámbar	Dimming	APZ	53	Negro	8424450264010
63150001181301	RE2418D-SCLBL53	24	PC Ámbar	Dimming	SCL	53	Negro	8424450264027
63150001220101	RE2422D-PBL53	24	2200K	Dimming	P	53	Negro	8424450205556
63150001220201	RE2422D-SPBL53	24	2200K	Dimming	SP	53	Negro	8424450232347
63150001220601	RE2422D-T2BL53	24	2200K	Dimming	T2	53	Negro	8424450264034
63150001220701	RE2422D-MEBL53	24	2200K	Dimming	ME	53	Negro	8424450264041
63150001220801	RE2422D-T3BL53	24	2200K	Dimming	T3	53	Negro	8424450264058
63150001220901	RE2422D-APZBL53	24	2200K	Dimming	APZ	53	Negro	8424450264065
63150001221301	RE2422D-SCLBL53	24	2200K	Dimming	SCL	53	Negro	8424450264072
63150001300101	RE2430D-PBL53	24	3000K	Dimming	P	53	Negro	8424450200797
63150001300201	RE2430D-SPBL53	24	3000K	Dimming	SP	53	Negro	8424450201152
63150001300601	RE2430D-T2BL53	24	3000K	Dimming	T2	53	Negro	8424450264089
63150001300701	RE2430D-MEBL53	24	3000K	Dimming	ME	53	Negro	8424450264096
63150001300801	RE2430D-T3BL53	24	3000K	Dimming	T3	53	Negro	8424450264102
63150001300901	RE2430D-APZBL53	24	3000K	Dimming	APZ	53	Negro	8424450264119
63150001301301	RE2430D-SCLBL53	24	3000K	Dimming	SCL	53	Negro	8424450264126
63150001400101	RE2440D-PBL53	24	4000K	Dimming	P	53	Negro	8424450200810
63150001400201	RE2440D-SPBL53	24	4000K	Dimming	SP	53	Negro	8424450201138
63150001400601	RE2440D-T2BL53	24	4000K	Dimming	T2	53	Negro	8424450264133
63150001400701	RE2440D-MEBL53	24	4000K	Dimming	ME	53	Negro	8424450264140
63150001400801	RE2440D-T3BL53	24	4000K	Dimming	T3	53	Negro	8424450247440
63150001400901	RE2440D-APZBL53	24	4000K	Dimming	APZ	53	Negro	8424450264157
63150001401301	RE2440D-SCLBL53	24	4000K	Dimming	SCL	53	Negro	8424450264164

RENOVACIÓN DEL ALUMBRADO (RETROFIT)

ACCESORIOS



REF. PEDIDO	REF. LÓGICA	DESCRIPCIÓN	EAN13
Accesorios			
6902010010	RFV1	Marco adaptable para Farol Villa, 280-320mm	8424450196311
6902010020	RFV2	Marco adaptable para Farol Villa, 300-340mm	8424450196328
6902010030	RFV3	Marco adaptable para Farol Villa, 340-380mm	8424450196335
6902010040	RFV4	Marco adaptable para Farol Villa, 380-420mm	8424450196342
6902010050	RFV5	Marco adaptable para Farol Villa, 420-460mm	8424450196359
6902020010	RFF1	Marco adaptable para Farol Fernandina, 290-326mm	8424450196380
6902020020	RFF2	Marco adaptable para Farol Fernandina, 326-353mm	8424450196397
6902020030	RFF3	Marco adaptable para Farol Fernandina, 353-395mm	8424450196403
6902020040	RFF4	Marco adaptable para Farol Fernandina, 371-412mm	8424450196410
6902020050	RFF5	Marco adaptable para Farol Fernandina, 412-454mm	8424450196427



▲ Marco adaptable para Farol Villa



▲ Marco adaptable para Farol Fernandina



CONTROL DE CUADRO ELÉCTRICO



REF. PEDIDO	REF. LÓGICA	DESCRIPCIÓN	EAN13
Control de cuadro eléctrico			
692001	RMC	Concentrador para cuadro eléctrico	8424450231166
692010	ACT	Actuador multifuncional para cuadro eléctrico, Instalación en carril DIN	8424450231173

CONTROL PUNTO A PUNTO

REF. PEDIDO	REF. LÓGICA	DESCRIPCIÓN	EAN13
Nodos Tipo Nema			
695011	IOTNSIM	Nodo de Telegestión NB-IoT, tipo NEMA para luminarias serie N. 1 año de conectividad	8424450223222
★ 695021	IOTNSIM1NCE	Nodo de Telegestión NB-IoT, tipo NEMA para luminarias serie N. 10 años de conectividad	8424450276945
Nodos Tipo Box			
695111	IOTBXSIM	Nodo de Telegestión NB-IoT, tipo BOX instalable de forma independiente. 1 año de conectividad	8424450223246
★ 695121	IOTBXSIM1NCE	Nodo de Telegestión NB-IoT, tipo BOX instalable de forma independiente. 10 años de conectividad	8424450276921



▲ 695011



▲ 695111

PLATAFORMA AURANT IOT

REF. PEDIDO	REF. LÓGICA	DESCRIPCIÓN	EAN13
Plataforma Aurant Iluminación			
694801	LIGSAASLUM	Telegestión Full Service para Módulo de Iluminación LED. Cuota anual/luminaria	8424450246603
694802	LIGSAASPANEL	Telegestión Full Service para Módulo de Iluminación LED. Cuota anual/cuadro concentrador	8424450246610

AURANT

MÓDULO ILUMINACIÓN

Plataforma web para la telegestión de redes de iluminación
Alcanza el máximo ahorro, gracias al control total del alumbrado

aurant-lighting.televes.com



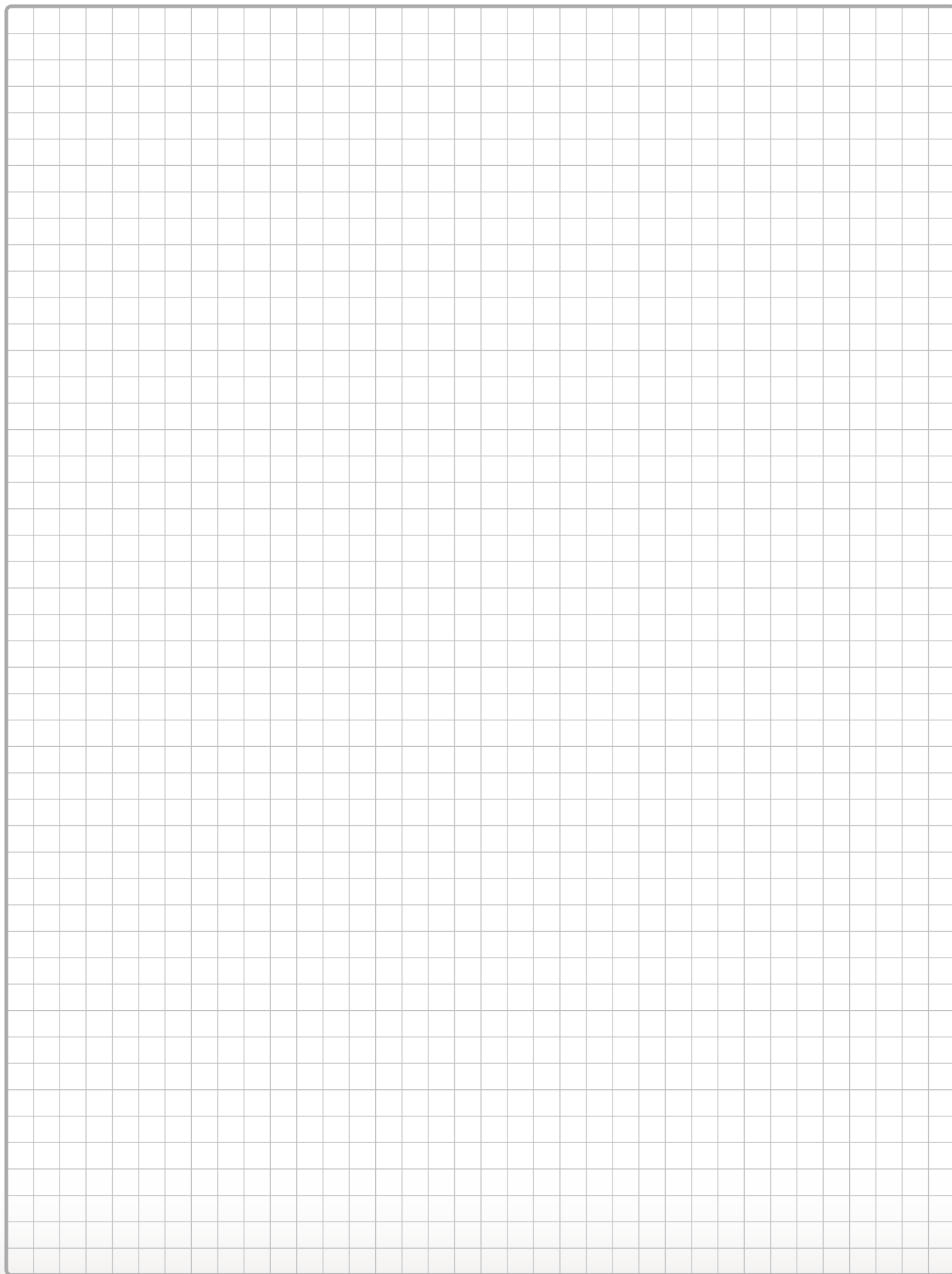

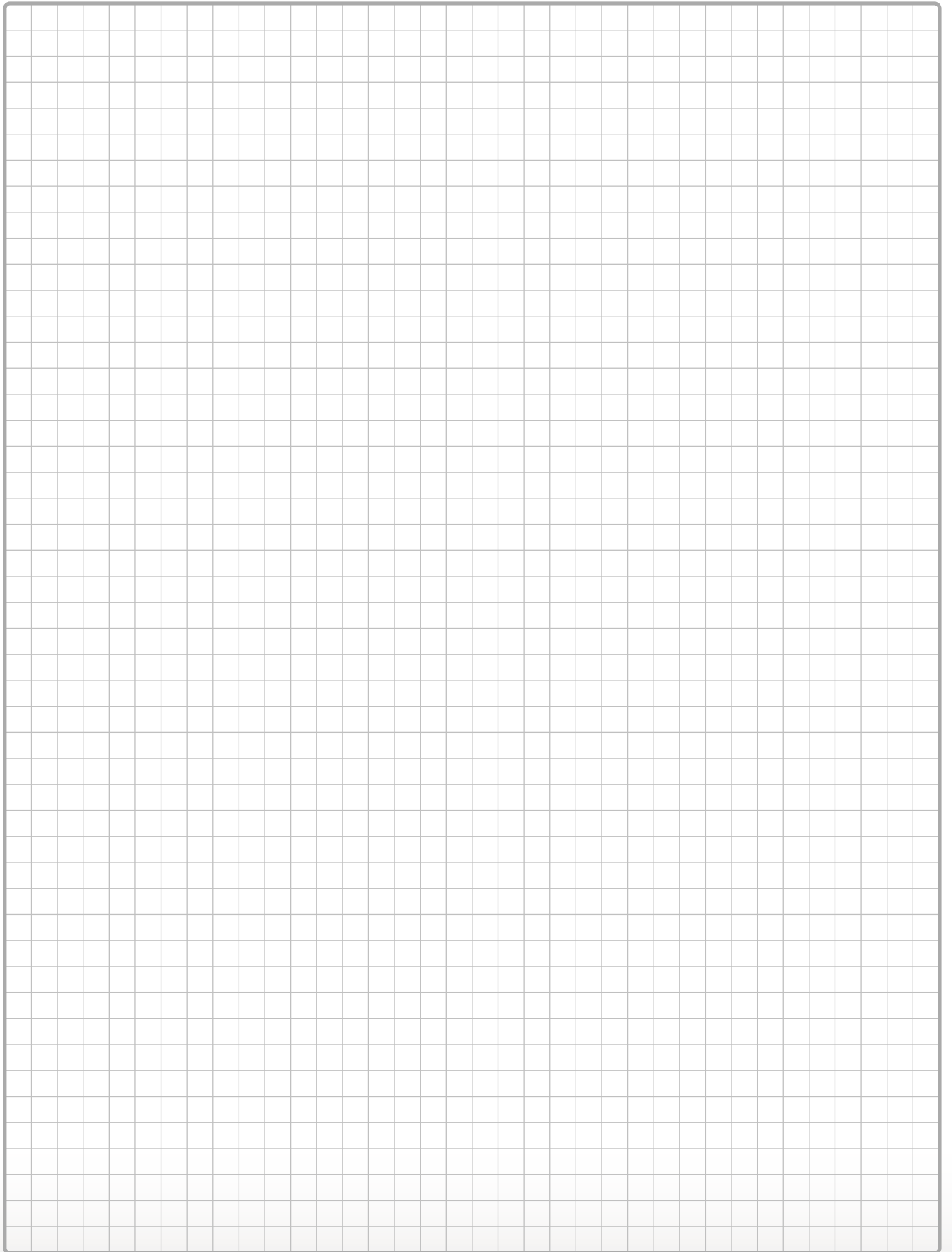

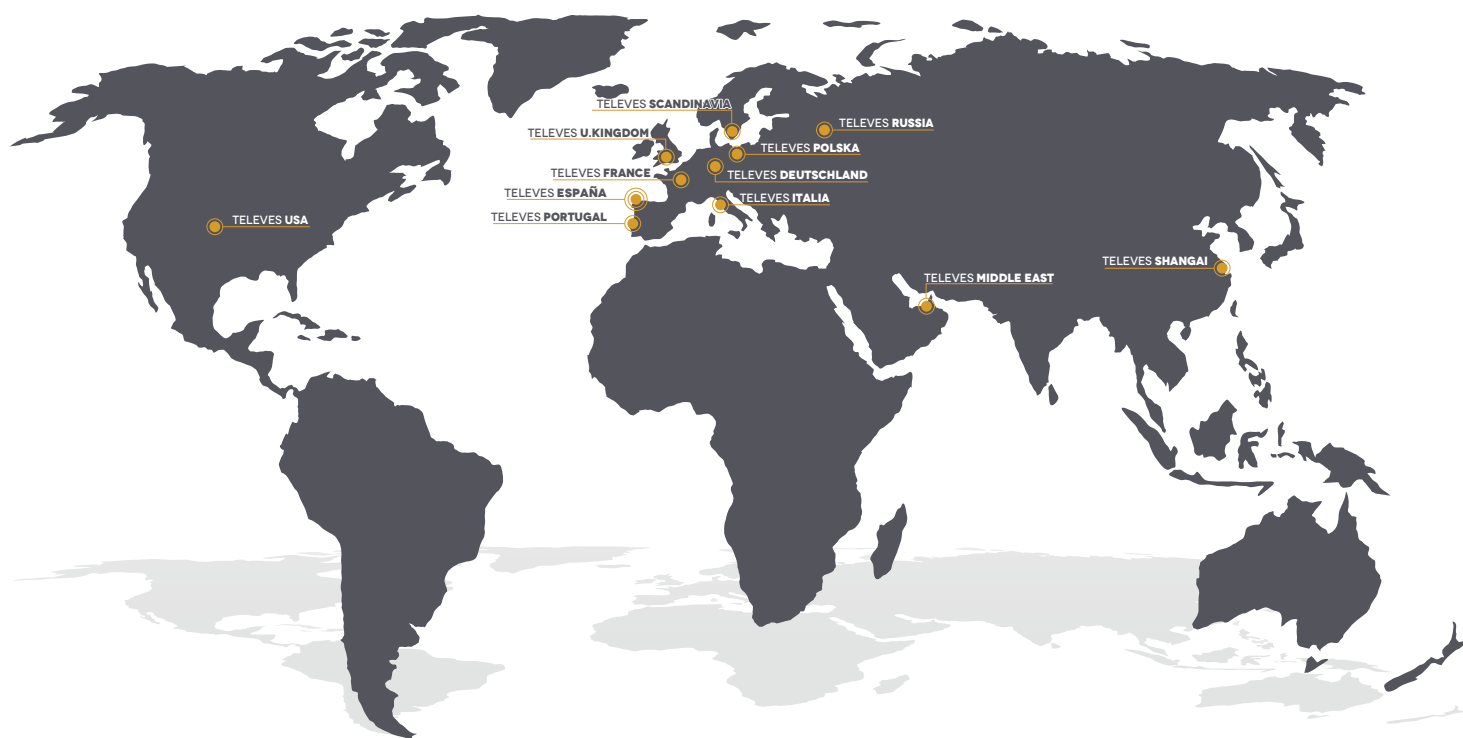

PASSION for QUALITY

SPAIN (HEAD OFFICE)

Televes S.A.U.

Rúa B. de Conxo, 17
15706 Santiago de Compostela
42° 51' 43.6212" N, 8° 33' 27.702" W
T. +34 981 52 22 00
F. +34 981 52 22 62
televes@televes.com

BARCELONA

Carrer Sant Ferrán, 27
08940 Cornellà de Llobregat (Barcelona)
41° 21' 9.054" N, 2° 5' 7.8324" E
T. +34 902 68 64 15
F. +34 934 74 50 06
barcelona@televes.com

LAS PALMAS

Gral. Mas de Gaminde, 26
35006 Las Palmas
28° 7' 55884" N, 15° 26' 1.356" W
T. +34 902 68 64 07
F. +34 928 23 13 66
laspalmas@televes.com

MADRID

Paseo de los Pontones, 11
28005 Madrid
40° 24' 22.5576" N, 3° 42' 46.35" W
T. +34 902 68 64 16
F. +34 914 74 54 21
madrid@televes.com

FRANCE

Televes France SAS

1 Rue Louis de Broglie
Parc d'Activités de l'Esplanade
77400 St. Thibault des Vignes (FRANCE)
48° 51' 48.5136" N, 2° 40' 26.0724" E
T. +33 0 1 60 359 210
F. +33 0 1 60 359 040
televes.fr@televes.com

GERMANY

Televes Deutschland GmbH
Küferstraße 20,
73257 Köngen (GERMANY)
48° 40' 42.0168" N, 9° 22' 25.932" E
T. +49 70 244 6860
F. +49 70 246 295
televes.de@televes.com

ITALY

Televes Italia S.r.l.
S. op. Viale Liguria 16,
20068 Peschiera Borromeo (MI) (ITALY)
45° 25' 53.3784" N, 9° 19' 25.3272" E
T. +39 02 516 50604 (RA)
F. +39 02 553 07363
televes.it@televes.com

POLAND

Televes Polska Sp. z o.o.
ul. Jana Długosza 48,
51-162 Wrocław (POLAND)
51° 7' 59.8224" N, 17° 3' 42.8256" E
T. +48 71 790 1115
F. +48 71 790 1112
televes.polska@televes.com

PORTUGAL

Televes Electrónica Portuguesa Lda.

Via Dr. Francisco Sá Carneiro. Lote 17.
Zona Ind. Maia 1. Sector-X.
4470-518 Barca, Maia (PORTUGAL)
41° 14' 58.344" N, 8° 37' 48.2196" O
T. +351 22 947 8900
F. +351 22 948 8719
GSM +351 96 858 1614
televes.pt@televes.com

LISBOA

Rua Augusto Gil, 21A.
1000-518 Lisboa
38° 44' 38" N, 09° 08' 27" O
T. +351 21 793 2537
F. +351 21 793 2418
televes.lisboa@televes.com

RUSSIA

Televes RUSS.
Volokolamskoye shosse, 142, str.6, 603, 617
125464 Moscow (RUSSIA)
55° 49' 46.05" N, 37° 22' 16.45" E
T. +7 495 107 90 95
F. +7 495 107 90 96
televes.russ@televes.com

SCANDINAVIA

Televes Scandinavia AB.
Vannhögsgatan 7,
231 66 Trelleborg (SWEDEN)
55° 23' 05.7" N, 13° 08' 42.3" E
T. +46 410 36 36 00
F. +46 410 36 36 01
televes.sc@televes.com

UNITED ARAB EMIRATES

Televes Middle East FZE

P.O. Box 17199
Jebel Ali Free Zone Dubai (UAE)
24° 57' 39.7548" N, 55° 3' 48.8232" E
T. +971 4 88 34 344
F. +971 4 88 34 644
televes.me@televes.com

UNITED KINGDOM

Televes United Kingdom Ltd.
Unit 11 Hill Street, Industrial Estate
Cwmbran, Gwent NP44 7PG (UK)
51° 38' 34.8144" N, 3° 1' 23.88" W
T. +44 01 633 875 821
F. +44 01 633 866 311
televes.uk@televes.com

USA

Televes USA LLC.
Norfolk Tech Center,
16596 E. 2nd Avenue
Aurora, CO 80011 (USA)
39° 7' 19.9497" N, 104° 7' 59.915" W
T. +1 (720) 379-3748
televes.usa@televes.com

CHINA

Televes Trade (Shanghai) Co., Ltd.
Unit 207-208, Building A, No 374
Wukang Rd, Xuhui District Shanghai
P.R.C. 200031 (CHINA)
31° 12' 23.5692" N, 121° 26' 21.9804" E
T. +86 21 6126 7620
F. +86 21 6466 6431
shanghai@televes.com.cn

FLEX

Iluminación modular de alta potencia

PARA INSTALACIONES DEPORTIVAS PROFESIONALES
Y GRANDES ÁREAS



Los nuevos proyectores modulares de alto rendimiento y elevada potencia, son la solución perfecta para alumbrar con la máxima eficiencia grandes espacios abiertos, como instalaciones deportivas y áreas de recreo.

Su diseño escalable, de 1 a 4 módulos sobre un único soporte y las diferentes configuraciones por módulo (potencia, óptica y n.º de LEDs), ofrecen una gama de 250 a 1200 W.

Un amplio abanico de posibilidades que convierte a los proyectores Flex en una elección acertada para cualquier espacio.



DISEÑO
MODULAR



CALIDAD
LUMÍNICA



FIABILIDAD



AHORRO
ENERGÉTICO



DRIVER
CERTIFICACIÓN
ENEC



Descarga el catálogo
informativo aquí

es.televes.com/flex

www.televescorporation.com | www.televes.com



Televes®



TECNOLOGÍA QUE NOS UNE

Televes Corporación es el núcleo de un grupo de compañías tecnológicas, referente en diseño y desarrollo de equipamiento para todo tipo de infraestructuras de telecomunicaciones en viviendas, edificios y ciudades.

Televes Corporación agrupa a más de 20 empresas que trabajan persiguiendo el objetivo común de diseñar, desarrollar y fabricar en España productos y soluciones de gran calidad para diversos sectores en el ámbito de las telecomunicaciones, como la transmisión y distribución de servicios de televisión, la implantación de redes multiservicio en Hospitality, desarrollo de plataformas socio-sanitarias avanzadas así como soluciones para proyectos integrales de iluminación LED profesional.

Arantia | Assamblia | Gainsa | Gamelsa | GCE | Gsertel | ISF | Maxwell | Televes | TRedess

España | Portugal | United Kingdom | France | United Arab Emirates | Italia | United States | Deutschland | Shanghái | Polska | Russia | Scandinavia



Televes Corporation®

www.televescorporation.com | www.televes.com



Televes