

INTERNATIONAL

# Televes®

PRODUCT  
GUIDE **2018**



**PASSION** for QUALITY

A HIGH PERFORMANCE AND HIGH ACCURACY PORTABLE METER FOR PROFESSIONAL USERS

## THE POWER OF USER EXPERIENCE

Its innovative **gesture-control tactile display** allows you to operate MOSAIQ6 like a smartphone or tablet, **managing up to 6 simultaneous real-time widgets** on its high resolutions 8" screen.



**ULTRA-FAST SPECTRUM ANALYSER**  
Real time digital processing



**ALWAYS READY**  
Field-replaceable battery



**EFFICIENT MANAGEMENT**  
Meter always updated with the cloud



**ERGONOMICS**  
Optimized shape to maximize the effectiveness of movement



 WATCH THE VIDEO: [EN.TELEVES.COM/MOSAIQ6](http://EN.TELEVES.COM/MOSAIQ6)

<b>TELEVES IN THE WORLD.....</b>	<b>4</b>	<b>8 FIBER OPTICS (OPTICAL LNB) .....</b>	<b>28</b>
<b>1 TERRESTRIAL ANTENNAS .....</b>	<b>5</b>	F.O. Distribution (Optical LNB).....	28
Intelligent BOSS antennas .....	5	<b>9 MULTISWITCHES .....</b>	<b>29</b>
Passive antennas.....	6	NevoSwitch Series: Stand alone & Cascade multiswitches .....	29
Extended 4G Coverage .....	6	EasySwitch Series .....	30
Masts & supports .....	7	Cabinets.....	30
Steel wires .....	7	<b>10 DISTRIBUTION .....</b>	<b>31</b>
<b>2 SATELLITE ANTENNAS .....</b>	<b>8</b>	Splitters with "EasyF" connector.....	31
QSD Series ( <i>Quality Satellite Dishes</i> ).....	8	Splitters with "F" connector .....	31
ISD Series ( <i>Inox Satellite Dishes</i> ) .....	8	Splitters with 5/8" connector (outdoor) .....	31
Satellite dishes.....	8	Taps with "EasyF" connector .....	32
LNBs.....	9	Taps with "F" connector.....	32
Brackets & fixing accessories .....	9	Taps with "F" tap ports & 5/8"	
<b>3 TOWERS .....</b>	<b>10</b>	In/Out ports connectors (outdoor) .....	33
Pack Tower .....	10	Outlets .....	34
180 SE Tower .....	10	Connectors .....	35
180 Tower .....	10	<b>11 COAXIAL CABLE .....</b>	<b>36</b>
Q1500 Tower ( <i>Stainless steel</i> ).....	10	Coaxial cables .....	36
360 Tower .....	11	Underground cables .....	37
450 Tower .....	11	Microcable.....	37
550 Tower .....	12	Accessories.....	37
550XL Reinforced Tower.....	12	<b>12 DATA ENCLOSURES AND CABLES.....</b>	<b>39</b>
<b>4 FILTERS &amp; COMBINERS.....</b>	<b>13</b>	Racks, enclosures and UAP .....	39
LTE Filters .....	13	Data cables .....	39
Combiners .....	13	Data connectors.....	39
<b>5 AMPLIFICATION.....</b>	<b>14</b>	<b>13 SET TOP BOXES &amp; HOME ACCESSORIES.....</b>	<b>40</b>
Mast amplification.....	14	DTH STBs.....	40
MATV domestic amplifiers (47...694/790/862MHz) .....	15	Modulator.....	40
SMATV domestic amplifiers (47...2150MHz) .....	16	Audio/Video & IR transmission .....	40
CATV domestic amplifiers (5...862MHz).....	16	IR over RF transmission.....	40
Sky pass amplifiers .....	16	IR over coaxial cable transmission .....	40
Amplifiers: MiniKom "EasyF" Series.....	16	<b>14 TOOLS.....</b>	<b>41</b>
Amplifiers: MiniKom "F" Series.....	17	Fiber optics .....	41
Amplifiers: DTKom Series.....	17	Signal generators .....	41
Amplifiers: Outdoor Series .....	18	<b>15 MEASURING EQUIPMENT .....</b>	<b>42</b>
Amplifiers: MicroKom Series.....	18	Field strength meters.....	42
Programmable Amplification: Avant Series .....	19	<b>16 DATA TECHNOLOGY .....</b>	<b>43</b>
<b>6 PROCESSING HEADENDS.....</b>	<b>21</b>	CoaxData Series .....	44
T.OX Series .....	22	FibreData Solutions:	
Wall mount .....	23	GPON ( <i>Gigabit-capable Passive Optical Networks</i> ).....	44
Modulator + Encoders (Rack mount).....	23	<b>17 ARANTIA TV .....</b>	<b>46</b>
<b>7 FIBER OPTICS .....</b>	<b>24</b>	<b>18 ARANTIA DS .....</b>	<b>48</b>
T.OX Series .....	24	<b>19 ARANTIACAST.....</b>	<b>50</b>
F.O. Distribution (Stand alone Transmitters and Optical Nodes)..	25		
F.O. Distribution.....	26		
F.O. Cables (ITU-T G657A2).....	27		
Accessories.....	27		

# Televes® in the world



## SPAIN (HEAD OFFICE) 🇪🇸

Televes S.A.  
Rúa B. de Conxo, 17  
15706 Santiago de Compostela  
42° 51' 43.6212" N, 8° 33' 27.702" W  
T. +34 981522200  
F. +34 981522262  
televes@televes.com

## BARCELONA

Carrer Sant Ferrán, 27  
08940 Cornellà de Llobregat (Barcelona)  
41° 21' 9.054" N, 2° 5' 7.8324" E  
T. +34 902686415  
F. +34 934745006  
barcelona@televes.com

## LAS PALMAS

Gral. Mas de Gaminde, 26  
35006 Las Palmas  
28° 7' 55.884" N, 15° 26' 1.356" W  
T. +34 902686407  
F. +34 928231366  
laspalmas@televes.com

## MADRID

Paseo los Pontones, 11  
28005 Madrid  
40° 24' 22.5576" N, 3° 42' 46.35" W  
T. +34 902686416  
F. +34 914745421  
madrid@televes.com

## FRANCE

Televes France SAS  
1 Rue Louis de Broglie  
Parc d'Activités de l'Esplanade  
77400 St. Thibault des Vignes (FRANCE)  
48° 51' 48.5136" N, 2° 40' 26.0724" E  
T. +33 0 1 60 359 210  
F. +33 0 1 60 359 040  
televes.fr@televes.com

## GERMANY

Televes Deutschland GmbH  
Küferstraße 20,  
73257 Köngen (GERMANY)  
48° 40' 42.0168" N, 9° 22' 25.932" E  
T. +49 70 244 6860  
F. +49 70 246 295  
televes.de@televes.com

## ITALY

Televes Italia S.r.l.  
S. op. Viale Liguria 16,  
20068 Peschiera Borromeo (MI) (ITALY)  
45° 25' 53.3784" N, 9° 19' 25.3272" E  
T. +39 02 516 50604 (RA)  
F. +39 02 553 07363  
televes.it@televes.com

## POLAND

Televes Polska Sp. z o.o.  
ul. Jana Długosza 48,  
51-162 Wrocław (POLAND)  
51° 7' 59.8224" N, 17° 3' 42.8256" E  
T. +48 71 790 1115  
F. +48 71 790 1112  
televes.polska@televes.com

## PORTUGAL 🇵🇹

Televes Electrónica Portuguesa Lda.  
Via Dr. Francisco Sá Carneiro. Lote 17.  
ZONA Ind. Maia 1. Sector-X.  
4470-518 Barca, Maia (PORTUGAL)  
41° 14' 58.344" N, 8° 37' 48.2196" O  
T. +351 22 947 8900  
F. +351 22 948 8719  
GSM +351 96 858 1614  
televes.pt@televes.com

## LISBOA

Rua Augusto Gil, 21A.  
1000-518 Lisboa  
38° 44' 38" N, 09° 08' 27" O  
T. +351 21 793 2537  
F. +351 21 793 2418  
televes.lisboa@televes.com

## RUSSIA

Televes RUSS.  
Volokolamskoye shosse, 142, str.6, 603, 617  
125464 Moscow (RUSSIA)  
55° 49' 46.05" N, 37° 22' 16.45" E  
T. +7 495 107 90 95  
F. +7 495 107 90 96  
televes.russ@televes.com

## SCANDINAVIA

Televes Scandinavia AB.  
Vannhögsgatan 7,  
231 66 Trelleborg (SWEDEN)  
55° 23' 05.7" N, 13° 08' 42.3" E  
T. +46 410 36 36 00  
F. +46 410 36 36 01  
televes.sc@televes.com

## UNITED ARAB EMIRATES

Televes Middle East FZE  
P.O. Box 17199  
Jebel Ali Free Zone Dubai (UAE)  
24° 57' 39.7548" N, 55° 3' 48.8232" E  
T. +971 4 88 34 344  
F. +971 4 88 34 644  
televes.me@televes.com

## UNITED KINGDOM

Televes United Kingdom Ltd.  
Unit 11 Hill Street, Industrial Estate  
Cwmbran, Gwent NP44 7PG (UK)  
51° 38' 34.8144" N, 3° 1' 23.88" W  
T. +44 01 633 875 821  
F. +44 01 633 866 311  
televes.uk@televes.com

## USA

Televes USA LLC.  
1385 S Colorado Blvd, Suite A-108  
Denver, CO 80222 (USA)  
39° 69' 15.27" N, 104° 9' 41.206" W  
T. +1 303 256 6767  
televes.usa@televes.com

## CHINA

Televes Trade (Shanghai) Co., Ltd.  
Unit 207-208, Building A, No 374  
Wukang Rd, Xuhui District Shanghai  
P.R.C. 200031 (CHINA)  
31° 12' 23.5692" N, 121° 26' 21.9804" E  
T. +86 21 6126 7620  
F. +86 21 6466 6431  
shanghai@televes.com.cn

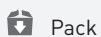

Pack

**TFORCE** TForce Technology

### Integrated protection against LTE:

#### LTE790

Channel 60 filtering (790MHz)

#### LTE700

Channel 48 filtering (694MHz)

**Dimensions:** xyz  
(width x height x depth)

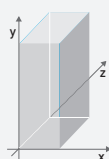

Identifying colour in product

- Orange
- ⊙ White
- Red
- Ⓡ Red-brick
- Grey
- Ⓢ Graphite
- Black
- Violet

Packaging type for coaxial cable

- Plastic reel
- ⊙ Cardboard reel
- Wooden drum
- ⊙ Plastified coil

Televes expresses that this document is just for information purposes and does not accept any responsibility that could be originated from possible errors or omissions regarding its content.

The product pictures included are not contractual and Televes could supply products as shown or these could suffer variations, modifications and/or alterations at any time and without notice.

TERRESTRIAL ANTENNAS

Ref.	Description		
<b>INTELLIGENT BOSS ANTENNAS</b>			
<b>DAT SERIES - with TForce Technology</b>			
149421	DAT BOSS MIX Terrestrial Antenna BIII/UHF (Ch5-12/21-48) G 8.5/16dBi BOSS OFF, G 36.5/41dBi BOSS ON (Single Packing)	LTE700	1
149422	DAT BOSS MIX Terrestrial Antenna BIII/UHF (Ch5-12/21-48) G 8.5/16dBi BOSS OFF, G 36.5/41dBi BOSS ON (Multiple Packing)	LTE700	6
149441	DAT BOSS MIX Terrestrial Antenna BIII/UHF (Ch5-12/21-60) G 8.5/16dBi BOSS OFF, G 36.5/44dBi BOSS ON (Single Packing)	LTE790	1
149442	DAT BOSS MIX Terrestrial Antenna BIII/UHF (Ch5-12/21-60) G 8.5/16dBi BOSS OFF, G 36.5/44dBi BOSS ON (Multiple Packing)	LTE790	6
149921	DAT BOSS Terrestrial Antenna UHF (Ch21-48) G 17dBi BOSS OFF, G 42dBi BOSS ON (Single Packing)	LTE700	1
149922	DAT BOSS Terrestrial Antenna UHF (Ch21-48) G 17dBi BOSS OFF, G 42dBi BOSS ON (Multiple Packing)	LTE700	6
149941	DAT BOSS Terrestrial Antenna UHF (Ch21-60) G 17dBi BOSS OFF, G 45dBi BOSS ON (Single Packing)	LTE790	1/5
149942	DAT BOSS Terrestrial Antenna UHF (Ch21-60) G 17dBi BOSS OFF, G 45dBi BOSS ON (Multiple Packing)	LTE790	6
149721	DAT BOSS LR Terrestrial Antenna UHF (Ch21-48) G 19dBi BOSS OFF, G 47dBi BOSS ON (Single Packing)	LTE700	1
149740	DAT BOSS LR Terrestrial Antenna UHF (Ch21-60) G 19dBi BOSS OFF, G 47dBi BOSS ON (Single Packing)	LTE790	1
<b>NOVA SERIES (SPECIAL ANTENNAS) - with TForce Technology</b>			
144021	DINOVA BOSS Terrestrial Antenna UHF (C21-48) G 7dBi BOSS OFF, G 34dBi BOSS ON	LTE700	1
144022	DINOVA BOSS Terrestrial Antenna UHF (C21-48) G 7dBi BOSS OFF, G 34dBi BOSS ON (Kit with accessories)	LTE700	1
144011	DINOVA BOSS Terrestrial Antenna UHF (Ch21-60) G 7dBi BOSS OFF, G 34dBi BOSS ON	LTE790	1
144012	DINOVA BOSS Terrestrial Antenna UHF (Ch21-60) G 7dBi BOSS OFF, G 34dBi BOSS ON (Kit with accessories)	LTE790	1
<b>NOVA SERIES (SPECIAL ANTENNAS)</b>			
144501	CAMPNOVA BOSS Terrestrial Antenna FM/BIII/UHF G -2/10/22dBi (Kit with accessories)		1
144441	OMNINOVA BOSS Terrestrial Antenna BI/FM/BIII/UHF G 26/20/28/30dBi (Kit with accessories)		1
<b>TV MOTION SYSTEM - DTT ON THE MOVE</b>			
144740	TRINOVA BOSS Terrestrial Antenna UHF G 25dBi (for Ref. 512501)		1
512501	TRIMOTION Digital Terrestrial Set-top Box (for Ref. 144740)		1
<b>INDOOR SERIES</b>			
130140	MIRA BOSS Indoor Terrestrial Antenna UHF (Ch21-60) G 35dBi		1
130201	INNOVA BOSS Indoor Terrestrial Antenna UHF (Ch21-60) G 30dBi		1
<b>Q-BOSS</b>			
562001	Q-BOSS 774 "EasyF" UHF (Ch21-58) G 12dB Vo 101dBμV		10
561902	Q-BOSS 782 "EasyF" UHF (Ch21-59) G 15dB Vo 101dBμV		10
561901	Q-BOSS 790 "EasyF" UHF (Ch21-60) G 15dB Vo 101dBμV		10
<b>INTELLIGENCE ACTIVATION ACCESSORIES (BOSS Tech)</b>			
5605	PicoKom Domestic Amplifier 1i/2o "EasyF": 47...862MHz G 12/20dB Vo 105dBμV AGC + Preamp/Powering 12V-150mA		1/10
545720	Domestic Amplifier 1i/(2o+TV) "IEC": 47...694MHz G 20dB Vs 110dBμV + Output TV Outlet G 12dB + Preamp.Pow. 12V-100mA (Blister T1)	LTE700	8
545740	Vs 110dBμV + Output TV Outlet G 12dB + Preamp.Pow. 12V-100mA Vo 106dBμV + Output TV Outlet G12dB +Preamp.Power. 12V-100mA	LTE790	1
5795	PicoKom Domestic Power Supply Unit 1i/2o "EasyF": 5...862MHz 24V-130mA		1/10
5504	Domestic Power Supply Unit 1i/2o "F" 5...862MHz 24V-130mA		1
5796	PicoKom Domestic Power Supply Unit 1i/1o "EasyF" SATmix: 5...2500MHz 12V-220mA		1/10
5501	Domestic Power Supply Unit 1i/2o "F" 5...862MHz 12V-220mA (UK Plug)		1
<b>PROTECTIVE ACCESSORIES</b>			
4947	Coaxial Atmospheric Surge Arrestor 90V 0...3GHz		1/20

DAT BOSS

TFORCE TECHNOLOGY



TForce Technology featured in the intelligence system (BOSS) antenna provide a high dynamic range, a higher gain and a low noise figure improving the coverage range in DTT installations.

IF DAT BOSS CANNOT DETECT IT, IT CANNOT BE SEEN.



SCAN TO WATCH THE VIDEO  
EN.TELEVES.COM/DATBOSS



▲ DAT BOSS LR



▲ DINOVA BOSS



▶ Q-BOSS



Ask us about our KITS with antenna and PSU.

Ref.	Description		
<b>PASSIVE ANTENNAS</b>			
<b>FM</b>			
1201	FM Terrestrial Antenna 88...108MHz Circular G 1dBi	○	1/5
<b>VHF, BAND III &amp; DAB</b>			
1050	BIII/DAB Terrestrial Antenna 174...240MHz 3 Elements G 8dBi (Single Packing)	○	1
105001	BIII/DAB Terrestrial Antenna 174...240MHz 3 Elements G 8dBi (Multiple Packing)	○	5
1065	BIII Terrestrial Antenna (Ch5-12) 7 Elements G 9.5dBi (Multiple Packing)	○	5
106501	BIII Terrestrial Antenna (Ch5-12) 7 Elements G 9.5dBi (Single Packing)	○	1
106601	V BIII Terrestrial Antenna (Ch5-12) 10 Elements G 9dBi (Single Packing)	○	1/6
<b>COMBINED VHF/ UHF (MIX)</b>			
149321	V ZENIT MIX Terrestrial Antenna BIII/UHF (Ch 5-12 / 21-48) G 8.5/13dBi (Single Packing)	LTE700 ○	1
149301	V ZENIT MIX Terrestrial Antenna BIII/UHF (Ch 5-12 / 21-58/59/60 Configurable bandwidth) G 8.5/15dBi (Single Packing)	LTE790 ○	1
149302	V ZENIT MIX Terrestrial Antenna BIII/UHF (Ch 5-12 / 21-58/59/60 Configurable bandwidth) G 8.5/15dBi (Multiple Packing)	LTE790 ○	10
<b>UHF</b>			
802440	Yagi Terrestrial Antenna UHF (Ch21-60) 10 Elements G 8.5dBi	LTE790 ○	15
802441	Yagi Terrestrial Antenna UHF (Ch21-60) 10 Elements G 8.5dBi Black	LTE790 B	15
111942	Yagi Edge Terrestrial Antenna UHF (Ch21-60) 10 Elements G 10dBi (Single Packing)	LTE790 ○	1
111940	Yagi Edge Terrestrial Antenna UHF (Ch21-60) 10 Elements G 10dBi (Multiple Packing)	LTE790 ○	15
111941	Yagi Edge Terrestrial Antenna UHF (Ch21-60) 10 Elements G 10dBi Black (Multiple Packing)	LTE790 B	15
112140	L 790 Terrestrial Antenna UHF (Ch21-60) 13 Elements G 13dBi	LTE790 ○	6
112141	L 790 Terrestrial Antenna UHF (Ch21-60) 13 Elements G 13dBi Black	LTE790 B	6
149221	V ZENIT Terrestrial Antenna UHF (Ch21-48) G 13dBi (Single packing)	LTE700 ○	1/6
149222	V ZENIT Terrestrial Antenna UHF (Ch21-48) G 13dBi (Multiple packing)	LTE700 ○	10
149201	V ZENIT Terrestrial Antenna UHF (Ch21-58/59/60 Configurable bandwidth) G 15dBi (Single Packing)	LTE790 ○	1/6
149202	V ZENIT Terrestrial Antenna UHF (Ch21-58/59/60 Configurable bandwidth) G 15dBi (Multiple Packing)	LTE790 ○	10
108320	Panel Terrestrial Antenna UHF(Ch21-48) 4 Dipoles G 13dBi	LTE700 ○	1
108341	Panel Terrestrial Antenna UHF(Ch21-60) 4 Dipoles G 14dBi Black	LTE790 B	1
<b>EXTENDED 4G COVERAGE</b>			
650101	4GNOVA Antenna 4G/LTE 698...960/1700...2700MHz G 7dBi (0.7m Female "N")	W	1
650102	4GNOVA Antenna 4G/LTE 698...960/1700...2700MHz G 7dBi (7.5m Male "SMA")	W	1



▲ L 790



▲ V ZENIT



▲ V ZENIT MIX



▲ 4GNOVA

What you need to know to choose the right NOVA special antenna?

	ANTENNA	RECEPTION TYPE	INSTALLATION RECOMMENDED FOR	HIGHLIGHT
	<b>NOVA</b>	STATIC	Emblematic buildings, Facades, Balconies	<ul style="list-style-type: none"> <li>Low visual impact.</li> </ul>
	<b>CAMPNOVA</b>	STATIC (Long term stay)	Caravans (Campings)	<ul style="list-style-type: none"> <li>Low visual impact.</li> <li>Mounting optimized to be installed in a caravan.</li> </ul>
	<b>OMNINOVA</b>	STATIC (Short term stay)	Caravans & Ships	<ul style="list-style-type: none"> <li>No need to be oriented.</li> </ul>
	<b>TRINOVA</b>	IN MOTION	Caravans, Ships & Buses	<ul style="list-style-type: none"> <li>Low visual impact.</li> <li>No need to be oriented.</li> <li>It is part of the complete system <b>TVMotion</b> (antenna+receptor) which is able to receive signals in all the directions and always choose the best one.</li> </ul>
	<b>4GNOVA</b>	STATIC	Housing	<ul style="list-style-type: none"> <li>Low visual impact.</li> <li>Reception of LTE 4G signals to extend the telephone coverage.</li> </ul>

# TERRESTRIAL ANTENNAS

Ref.	Description		
<b>MASTS &amp; SUPPORTS</b>			
<b>ZINC+RCP MASTS</b>			
3040	Swaged Mast Zinc+RCP 1.5m x Ø 40mm x Thickness 1.25mm	G	6
3041	Swaged Mast Zinc+RCP 2m x Ø 40mm x Thickness 1.25mm	G	4
242001	Mast Zinc+RCP 1m x Ø 35mm x Thickness 1mm	G	6
2407	Mast Zinc+RCP 1.45m x Ø 35mm x Thickness 1.5mm	G	8
3008	Mast Zinc+RCP 2.5m x Ø 35mm x Thickness 1.5mm	G	6
3042	Mast Zinc+RCP 2.5m x Ø 35mm x Thickness 1mm	G	6
3009	Mast Zinc+RCP 2.5m x Ø 40mm x Thickness 2mm	G	4
3072	Mast Zinc+RCP 3m x Ø 40mm x Thickness 2mm	G	4
3010	Mast Zinc+RCP 3m x Ø 45mm x Thickness 2mm	G	4
<b>HOT-DIP GALVANIZED MASTS</b>			
301002	Mast HDG 3m x Ø 45mm x Thickness 2mm	G	4
301003	Mast HDG+Red 3m x Ø 45mm x Thickness 2mm	R	1
<b>ZINC+COLOUR MASTS</b>			
307502	Mast Zinc+White 2m x Ø 45mm x Thickness 2mm	W	4
300802	Mast Zinc+White 2.5m x Ø 35mm x Thickness 1.5mm	W	6
3075	Mast Zinc+Red 3m x Ø 45mm x Thickness 2mm	R	4
<b>CLAMPS</b>			
2117	Mast Clamp Zinc+RCP for Window 586x300mm x Ø30mm	G	1
<b>SUPPORTS FOR CHIMNEY</b>			
2414	Tubular Mast Bracket Zinc+RCP for Chimney 415x345mm x Ø 30mm	G	1
2415	Reinforced Mast Bracket Zinc+RCP for Chimney 396x400mm	G	1
<b>SUPPORTS FOR BOLTING</b>			
2401	"L" Mast Bracket Zinc+RCP for Bolting 300mm	G	10
2403	"W" Mast Bracket Zinc+RCP for Bolting 250mm	G	10
2404	"U" Mast Bracket Zinc+RCP for Bolting 500mm	G	6
240410	"U" Mast Bracket Zinc+RCP for Bolting 300mm	G	6
2409	Angled Mast Bracket Zinc+RCP for Bolting 128mm	G	10
<b>SUPPORTS FOR EMBEDDING</b>			
2405	"I" Mast Bracket Zinc+RCP for Embedding 350mm	G	6
2406	"U" Reinforced Mast Bracket Zinc+RCP for Embedding 500mm	G	6
2410	"U" Reinforced Mast Bracket Zinc+RCP for Embedding 250mm	G	10
<b>ACCESSORIES</b>			
2047	Jaw Clamp Zinc+RCP for Masts Up Ø 25...45mm	G	10
2408	Saddle & Clamp Zinc+RCP for Guy Wire, Inner Ø 46mm	G	10
2412	Corner Piece Zinc+RCP for Chimney	G	10
2413	Mast Clamp Zinc+RCP Ø 35mm	G	6
<b>CABLE CLIPS</b>			
2000	Opened Clip for Coaxial Cable (100 units)		1/10
2011	Closed Clip for Coaxial Cable (100 units)		1/20
<b>STEEL WIRES</b>			
2043	Galvanized Steel Wire Ø 2mm		100
3034	Galvanized Steel Wire Ø 4mm		100
3059	Galvanized Steel Wire Ø 5mm		100
306001	Galvanized Steel Wire Ø 6mm		200

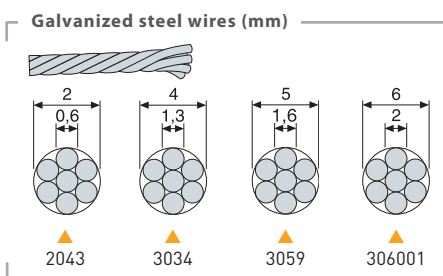
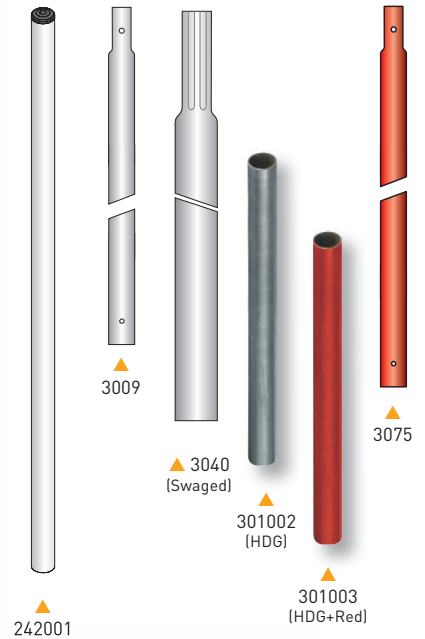

# SATELLITE ANTENNAS

Ref.	Description		
------	-------------	--	--

## QSD SERIES (Quality Satellite Dishes)

ALUMINIUM OFFSET DISHES			
7902	QSD High Quality Offset Dish 75 Aluminium G 38.5dBi (750x850mm) Orange		1
790204	QSD High Quality Offset Dish 75 Aluminium G 38.5dBi (750x850mm) White		1
7903	QSD High Quality Offset Dish 85 Aluminium G 39.5dBi (850x950mm) Orange		1
790304	QSD High Quality Offset Dish 85 Aluminium G 39.5dBi (850x950mm) White		1

## ISD SERIES (Inox Satellite Dishes)

ALUMINIUM OFFSET DISHES			
793001	ISD Offset Dish 630 Aluminium G 36,2dBi Orange		1
793002	ISD Offset Dish 630 Aluminium G 36,2dBi White		1
793003	ISD Offset Dish 630 Aluminium G 36,2dBi Graphite		1
793004	ISD Offset Dish 630 Aluminium G 36,2dBi Red-brick		1
793011	ISD Offset Dish 630 Aluminium G 36,2dBi Orange (Multiple packing)		10
793012	ISD Offset Dish 630 Aluminium G 36,2dBi White (Multiple packing)		10
793013	ISD Offset Dish 630 Aluminium G 36,2dBi Graphite (Multiple packing)		10
793014	ISD Offset Dish 630 Aluminium G 36,2dBi Red-brick (Multiple packing)		10
793101	ISD Offset Dish 830 Aluminium G 39dBi Orange		1
793102	ISD Offset Dish 830 Aluminium G 39dBi White		1
793103	ISD Offset Dish 830 Aluminium G 39dBi Graphite		1
793104	ISD Offset Dish 830 Aluminium G 39dBi Red-brick		1
793111	ISD Offset Dish 830 Aluminium G 39dBi Orange (Multiple packing)		5
793112	ISD Offset Dish 830 Aluminium G 39dBi White (Multiple packing)		5
793113	ISD Offset Dish 830 Aluminium G 39dBi Graphite (Multiple packing)		5
793114	ISD Offset Dish 830 Aluminium G 39dBi Red-brick (Multiple packing)		5

## SATELLITE DISHES

ALUMINIUM OFFSET DISHES			
757401	Offset Dish 1300 Aluminium G 42dBi White		10

STEEL OFFSET DISHES			
7534	Offset Dish 1000 Steel G 40.5dBi Orange		1
753401	Offset Dish 1000 Steel G 40.5dBi White		1
753410	Offset Dish 1000 Steel G 40.5dBi Orange (Multiple Packing)		5
753411	Offset Dish 1000 Steel G 40.5dBi White (Multiple Packing)		5
753421	Offset Dish 1000 Steel G 40.5dBi White (Multiple Packing)		100
7572	Offset Dish 1100 Steel G 41.5dBi Orange		1
757201	Offset Dish 1100 Steel G 41.5dBi White		1
7575	Offset Dish 1300 Steel G 42dBi White (Multiple Packing)		20

## QSD SERIES



The long life alluminium dish, quality signal reception for life.  
TÜV approved (german certifying organization).



▲ ISD Series

This new range of satellite dishes is built using aluminium and stainless steel to guarantee the protection against rust.

The bracket and LNB holder are built using a special polymer widely used in a highly professional sector, and reinforced with fiberglass for an extreme resistance.

Its improved structure has been designed to make assembly easier.



A00388



SCAN TO WATCH THE VIDEO  
EN.TELEDDES.COM/ISD

Compatibility between supports & dishes								
Ø Support	35	40	45			48	60	
Dishes	7393	719203	7349	7371	719202	757602	7576	719201
630	✓	✓	✓	✓	✓	✗	✗	✗
830	✓	✓	✓	✓	✓	✓	✓	✓
1000	✗	✗	✗	✗	✓	✗	✓	✓
1100	✗	✗	✗	✗	✗	✗	✓	✓
1300	✗	✗	✗	✗	✗	✗	✓	✓
ISD	✓	✓	✓	✓	✓	✓	✓	✓
QSD	✗	✓	✓	✓	✓	✓	✓	✓



▲ Offset Dish 630/830



**SATELLITE ANTENNAS**

Ref.	Description		
<b>LNBs</b>			
<b>OFFSET</b>			
7475	Offset LNB Single (Universal) Hh/Vh/HI/VI G 60dB	o	1/10
747701	Offset LNB Quattro Hh-Vh-HI-VI G 60dB	o	1/30
747802	Offset LNB Twin (2 Outputs Hh/Vh/HI/VI) G 60dB	o	1/30
761001	Offset LNB Quad (4 Outputs Hh/Vh/HI/VI) G 60dB	o	1/30
7613	Offset LNB Octo (8 Outputs Hh/Vh/HI/VI) G 57dB	o	1/30
7611	Offset LNB Monoblock (2 Universal LNBs) G 57dB Grey. 800 dishes only	g	1/30
<b>PRIME FOCUS</b>			
749401	P.F. LNB Quattro Hh-Vh-HI-VI G 55dB Grey	g	1
<b>OPTICAL FIBER</b>			
2353	Offset Optical LNB 1310nm "FC/PC" G 72dB Po 7dBm (Up to 32 converters), Grey	g	1
2363	P.F. Optical LNB 1310nm "FC/PC" G 72dB Po 7dBm Grey	g	1
<b>ACCESSORIES</b>			
7450	Current Injector 10...2150MHz 24Vdc-1A		1/20
7485	Line Amplifier 1i/2o "F": UHF/SAT[dc] G -2,5/20dB Vo 112.5dBμV		1/10
7268	DiSEqC 2.0 Switch 2i/1o 0...2400MHz		1/10
7269	DiSEqC 2.0 Switch 4i/1o 5...2150MHz (with Weatherproof Case)		1/10
4163	Outdoor Case Grey Large Model Dimensions: External 136x127x45mm Internal 125x97x35mm	g	1/5
<b>BRACKETS &amp; FIXING ACCESSORIES</b>			
<b>HOT-DIP GALVANIZED BRACKETS</b>			
757602	"T" Bracket HDG Ground Mount 1000x200mm / Ø48mm x Thickness 2.9mm	g	1
<b>GALVANIZED BRACKETS</b>			
719201	"Y" Bracket Galvanized Wall/Ground Mount 551x439mm or 620x247mm / Ø 60mm x Thickness 1.5mm	g	5
719202	"Y" Bracket Galvanized Wall/Ground Mount 728x473mm or 720x481mm / Ø 45mm x Thickness 1.5mm	g	1
<b>ZINC+RCP BRACKETS</b>			
7393	"L" Bracket Zinc+RCP Wall Mount 284x194mm / Ø 35mm x Thickness 1.5mm	g	10
7349	"L" Bracket Zinc+RCP Wall Mount 380x350mm / Ø 45mm x Thickness 1.5mm	g	5
7371	"L" Bracket Zinc+RCP Wall Mount 500x450mm / Ø 45mm x Thickness 2mm	g	5
7576	"T" Bracket Zinc+RCP Ground Mount 750x200mm / Ø 60mm x Thickness 2.9mm	g	1
<b>BASES</b>			
7409	Embedded Base Zinc+RCP for Ref.7576 or 757602, Height 200mm	g	1
<b>MULTISATELLITE SUPPORTS</b>			
790901	Multi-feed Support Up to 4 SAT, QSD Dishes Includes: Rail (up to 20°) + 1 LNB Support (Ref.790902)		1/10
790902	LNB Support for QSD Dishes		1/10



▲ 7475 (SINGLE)      ▲ 747802 (TWIN)



▲ 747701 (QUATTRO)      ▲ 761001 (QUAD)



▲ 749401



▲ 2353



▲ 757602



▲ 7393



▲ 790901



▲ 7371

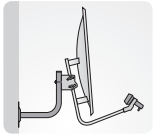

▲ 7349

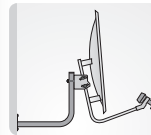

▲ 7576

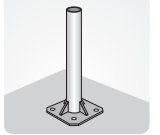

▲ 7576

**Galvanized brackets**

Ref.	Wall mount	Ground mount
719201	551 x 439	620 x 247
719202	728 x 473	720 x 481

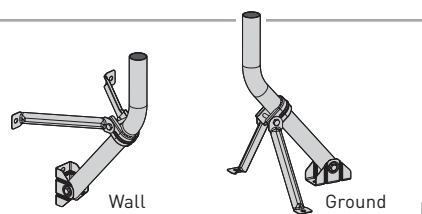

Wall      Ground

# TOWERS

Ref.	Description		
<b>PACK TOWER</b>			
<b>COMPLETE TOWER</b>			
306501	"Pack" Tower Galvanized+Orange 2.2m (Mast and Accessories included)		1
<b>180 SE TOWER</b>			
<b>ZINC+RCP SECTIONS</b>			
3014	Upper Section 180 SE Tower Zinc+RCP 1.25m (mast Ømax 35mm)		1
3015	Upper Section 180 SE Tower Zinc+RCP 2.5m, with Wire Ring (mast Ømax 35mm)		1
3017	Middle Section 180 SE Tower Zinc+ RCP 2.5m		1
<b>ACCESSORIES</b>			
3019	Fixed Embedded Base 180 SE Tower Zinc+RCP		1
3020	Fixed Bolting Base 180 SE Tower Zinc+RCP		1
<b>180 TOWER</b>			
<b>ZINC+RCP SECTIONS</b>			
3021	Upper Section 180 Tower Zinc+RCP 1m (mast Ømax 46mm)		1
3032	Upper Section 180 Tower Zinc+RCP 3m (mast Ømax 46mm)		1
3031	Middle Section 180 Tower Zinc+RCP 3m		1
3037	Lower Section Pivoting 180 Tower Zinc+RCP 3m		1
<b>HOT-DIP GALVANIZED SECTIONS</b>			
303201	Upper Section 180 Tower HDG 3m (mast Ømax 46mm)		1
303101	Middle Section 180 Tower HDG 3m		1
303701	Lower Section Pivoting 180 Tower HDG 3m		1
<b>ACCESSORIES</b>			
3058	Guy Wire Ring 180/360 Tower Zinc+RCP		20
305801	Guy Wire Ring 180/360 Tower HDG		20
3029	Embedded Frame 180 Tower Zinc+RCP for Fixed Base (Ref. 3038)		1
3038	Fixed Bolting/Embedded (with frame) Base 180 Tower Zinc+RCP		1
303801	Fixed Bolting/Embedded (with frame) Base 180 Tower HDG		1
3048	Pivoting Embedded Base 180 Tower Zinc+ RCP		1
304801	Pivoting Embedded Base 180 Tower HDG		1
305001	Structural Cube 180 Tower Zinc+RCP 200mm		1
3034	Galvanized Steel Wire Ø 4mm		100
<b>Q1500 TOWER (Stainless Steel)</b>			
<b>COMPLETE TOWER</b>			
3049	Q1500 Tower Kit Stainless Steel 14.5m Stainless Steel Accessories included (Guy Wire at 1.5m)		1
304910	Q1500 Tower Bases Stainless Steel (1 tower base & 3 guy wire bases)		1



▲ Pack Tower (Ref. 306501)  
Compatible with support ref. 7349.



▲ 180 Sections

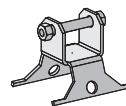
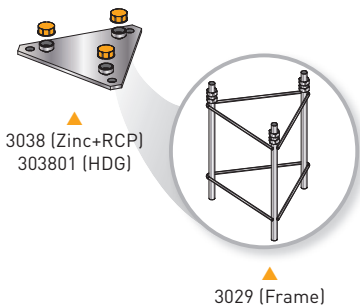

▲ 3048 (Zinc+RCP)  
304801 (HDG)

**Types of finishing**



**HDG**

Hot-Dip Galvanized



**Zinc + RCP**

Zinc plated + Reactive Coating Process



**HDG + Painting**

Hot-Dip Galvanized + Lacquered in oven with electrostatic powder of polyester



**Zinc + Painting**

Zinc plated + Lacquered in oven with electrostatic powder of polyester



▲ Q1500 Tower (Stainless steel)  
(Ref. 3049 + Ref. 304910)

Ref.	Description		
<b>360 TOWER</b>			
<b>ZINC+RCP SECTIONS</b>			
3085	Upper Section 360 Tower Zinc+RCP 3m (mast Ømax 52mm)	G	1
3087	Middle Section 360 Tower Zinc+RCP 3m	G	1
3086	Lower Section Pivoting 360 Tower Zinc+RCP 3m	G	1
<b>ZINC+COLOUR SECTIONS</b>			
308501	Upper Section 360 Tower Zinc+Red 3m (mast Ømax 52mm)	R	1
308502	Upper Section 360 Tower Zinc+White 3m (mast Ømax 52mm)	W	1
308701	Middle Section 360 Tower Zinc+Red 3m	R	1
308702	Middle Section 360 Tower Zinc+White 3m	W	1
308601	Lower Section Pivoting 360 Tower Zinc+Red 3m	R	1
308602	Lower Section Pivoting 360 Tower Zinc+White 3m	W	1
<b>HOT-DIP GALVANIZED SECTIONS</b>			
308503	Upper Section 360 Tower HDG 3m (mast Ømax 52mm)	G	1
308703	Middle Section 360 Tower HDG 3m	G	1
308603	Lower Section Pivoting 360 Tower HDG 3m	G	1
<b>HOT-DIP GALVANIZED+COLOUR SECTIONS</b>			
308504	Upper Section 360 Tower HDG+Red 3m (mast Ømax 52mm)	R	1
308704	Middle Section 360 Tower HDG+Red 3m	R	1
308705	Middle Section 360 Tower HDG+White 3m	W	1
308604	Lower Section Pivoting 360 Tower HDG+Red 3m	R	1
308605	Lower Section Pivoting 360 Tower HDG+White 3m	W	1
<b>ACCESSORIES</b>			
3088	Pivoting Embedded Base 360 Tower Zinc+RCP	G	1
308801	Pivoting Embedded Base 360 Tower HDG	G	1
3089	Fixed Embedded Base 360 Tower Zinc+RCP	G	1
308901	Fixed Embedded Base 360 Tower HDG	G	1
3058	Guy Wire Ring 180/360 Tower Zinc+RCP	G	20
305801	Guy Wire Ring 180/360 Tower HDG	G	20
3059	Galvanized Steel Wire Ø 5mm		100
<b>450 TOWER</b>			
<b>ZINC+COLOUR SECTIONS</b>			
3133	Upper Section 450 Tower Zinc+Red 3m (mast Ømax 62mm)	R	1
3132	Middle Section Reinforced 450 Tower Zinc+Red 3m	R	1
313201	Middle Section Reinforced 450 Tower Zinc+White 3m	W	1
3131	Middle Section 450 Tower Zinc+Red 3m	R	1
313101	Middle Section 450 Tower Zinc+White 3m	W	1
3130	Lower Section Pivoting Reinforced 450 Tower Zinc+Red 3m	R	1
<b>HOT-DIP GALVANIZED+COLOUR SECTIONS</b>			
313301	Upper Section 450 Tower HDG+Red 3m (mast Ømax 62mm)	R	1
313202	Middle Section Reinforced 450 Tower HDG+Red 3m	R	1
313203	Middle Section Reinforced 450 Tower HDG+White 3m	W	1
313102	Middle Section 450 Tower HDG+Red 3m	R	1
313103	Middle Section 450 Tower HDG+White 3m	W	1
313001	Lower Section Pivoting Reinforced 450 Tower HDG+Red 3m	R	1
<b>ACCESSORIES</b>			
312901	Surface Plate 450/550 Tower for Pivoting Base (Refs. 3134/01 & 3142/01) Zinc+RCP	G	1
3134	Pivoting Embedded/Bolting (with plate) Base 450 Tower Zinc+Red	R	1
313401	Pivoting Embedded/Bolting (with plate) Base 450 Tower HDG	G	1
313501	Fixed Embedded Base 450 Tower Zinc+RCP	G	1
3144	Guy Wire Ring 450/550 Tower Zinc+RCP	G	1
314401	Guy Wire Ring 450/550 Tower HDG	G	1
306001	Galvanized Steel Wire Ø 6mm		200

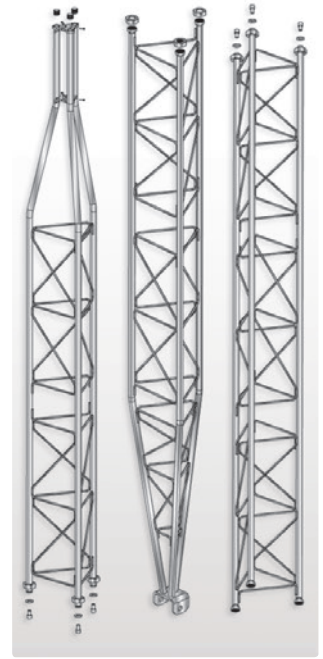

▲ 360 Sections

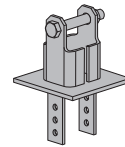

▲ 3088 (Zinc+RCP)  
308801 (HDG)

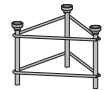

▲ 3089 (Zinc+RCP)  
308901 (HDG)

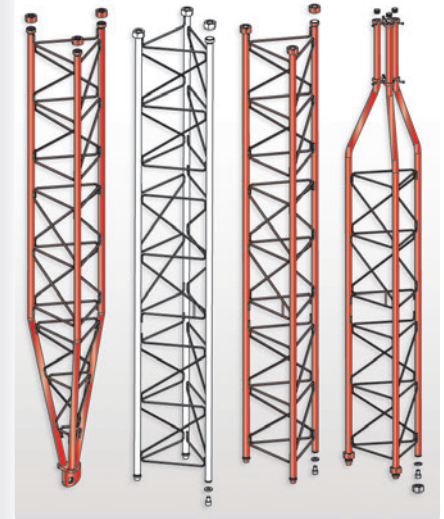

▲ 450 Sections

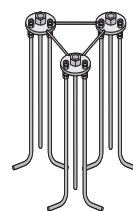

▲ 313501 (Zinc+RCP)

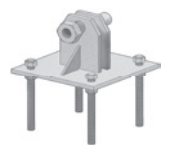

▲ 3134 (Zinc+Red)  
313401 (HDG)

# TOWERS

Ref.	Description		
<b>550 TOWER</b>			
<b>ZINC+COLOUR SECTIONS</b>			
3141	Transition Section 550 to 450 Tower Zinc+Red 3m	R	1
3140	Middle Section 550 Tower Zinc+Red 3m	R	1
314001	Middle Section 550 Tower Zinc+White 3m	W	1
313901	Lower Section Pivoting 550 Tower Zinc+Red 3m	R	1
<b>HOT-DIP GALVANIZED+COLOUR SECTIONS</b>			
314101	Transition Section 550 to 450 Tower HDG+Red 3m	R	1
314002	Middle Section 550 Tower HDG+Red 3m	R	1
314003	Middle Section 550 Tower HDG+White 3m	W	1
313902	Lower Section Pivoting 550 Tower HDG+Red 3m	R	1
<b>ACCESSORIES</b>			
312901	Surface Plate 450/550 Tower for Pivoting Base (Refs. 3134/01 & 3142/01) Zinc+RCP	G	1
3142	Pivoting Embedded/Bolting (with plate) Base 550 Tower Zinc+Red	R	1
314201	Pivoting Embedded/Bolting (with plate) Base 550 Tower HDG+Red	R	1
3143	Fixed Embedded Base 550 Tower Zinc+RCP	G	1
314301	Fixed Embedded Base 550 Tower HDG	G	1
3144	Guy Wire Ring 450/550 Tower Zinc+RCP	G	1
314401	Guy Wire Ring 450/550 Tower HDG	G	1
306001	Galvanized Steel Wire Ø 6mm		200
<b>550XL - REINFORCED TOWER <sup>(1)</sup></b>			
<b>HOT-DIP GALVANIZED+COLOUR SECTIONS</b>			
313810	Top Mast Holder 550XL Reinforced Tower HDG+Red 0.25m (mast Ømax 62mm)	R	1
314010	Middle Section 550XL Reinforced Tower HDG+Red 3m	R	1
314011	Middle Section 550XL Reinforced Tower HDG+White 3m	W	1
313911	Lower Section Pivoting 550XL Reinforced Tower HDG+Red 3m	R	1
<b>ACCESSORIES</b>			
314210	Pivoting Embedded Base 550XL Reinforced Tower HDG+Red	R	1
314401	Guy Wire Ring 450/550 Tower HDG	G	1



▲ 550 Sections

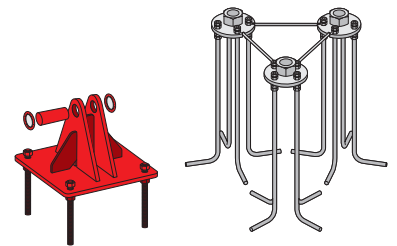

▲ 3142 (Zinc+Red)  
314201 (HDG+Red)

▲ 3143 (Zinc+RCP)  
314301 (HDG)

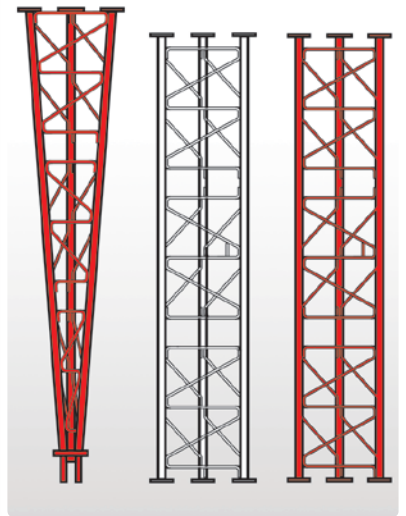

▲ 550XL Sections - Reinforced

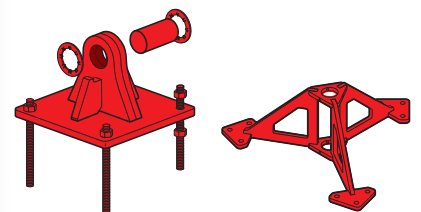

▲ 314210 (HDG+Red)

▲ 313810 (HDG+Red)

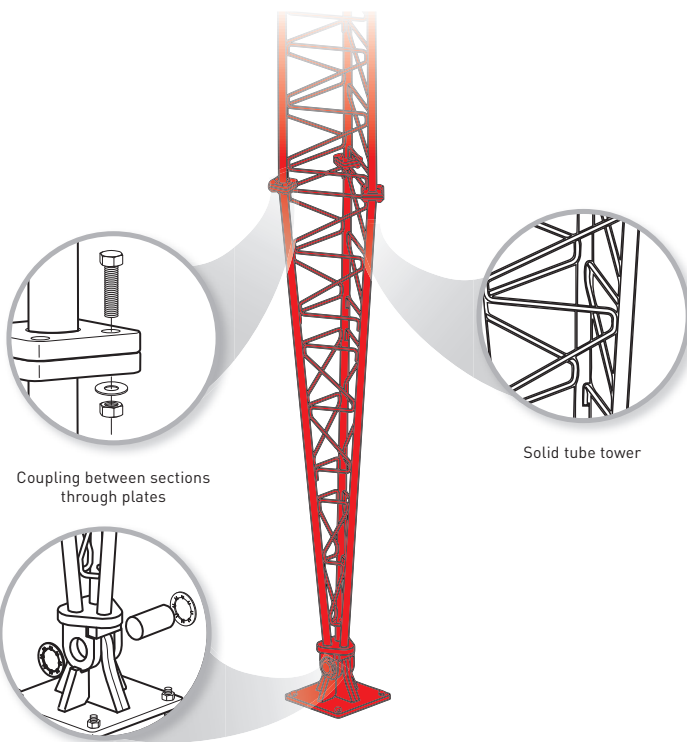

Coupling between sections through plates

Solid tube tower

Pivoting embedded base

▲ 550XL Sections - Reinforced

(1) Due to its assembly system with plates, the sections of the 550XL tower are not compatible with the rest of the tower range.

**FILTERS & COMBINERS**

Ref.	Description		
<b>LTE FILTERS</b>			
<b>"EasyF" CONNECTOR</b>			
405202	High Rejection LTE Filter (HR) "EasyF" 47...694MHz VHF/UHF (Ch21-48) Outdoor	LTE700	1/10
405101	Medium Rejection LTE Filter (MR) "EasyF" 470...774MHz UHF (Ch21-58) Outdoor	LTE790	1/10
405402	High Rejection LTE Filter (HR) "EasyF" 47...782MHz VHF/UHF (Ch21-59) Outdoor	LTE790	1/10
405401	High Rejection LTE Filter (HR) "EasyF" 47...790MHz VHF/UHF (Ch21-60) Outdoor	LTE790	1/10
<b>"F" CONNECTOR</b>			
403201	Medium Rejection LTE Filter (MR) "F" 47...694MHz VHF/UHF (Ch21-48), Indoor	LTE700	1/10
403101	Medium Rejection LTE Filter (MR) "F" 470...774MHz UHF (Ch21-58) Indoor	LTE790	1/10
403402	High Rejection LTE Filter (HR) "F" 47...782MHz VHF/UHF (Ch21-59) Indoor	LTE790	1/10
403401	High Rejection LTE Filter (HR) "F" 47...790MHz VHF/UHF (Ch21-60) Indoor	LTE790	1/10
403302	Very High Rejection LTE Microcavities Filter (VHR) "F" 5...782MHz VHF/UHF (Ch21-59) Selective, Indoor	LTE790	1/14
403301	Very High Rejection LTE Microcavities Filter (VHR) "F" 5...790MHz VHF/UHF (Ch21-60) Selective, Indoor	LTE790	1/14
403304	Ultra High Rejection LTE Microcavities Filter (VHR) "F" 5...782MHz VHF/UHF (Ch21-59) Selective, Indoor	LTE790	1/10
4163	Outdoor Case Grey Large Model Dimensions: External 136x127x45mm Internal 125x97x35mm	A	1/5
<b>"IEC" CONNECTOR</b> <span style="float:right">LTE790</span>			
404411	Medium Rejection LTE Filter (MR) "IEC" 470...774MHz UHF (Ch21-58) Indoor (Bag B3)		10
404401	High Rejection LTE Filter (HR) "IEC" 47...782MHz VHF/UHF (Ch21-59) Indoor		10/50
404412	High Rejection LTE Filter (HR) "IEC" 47...790MHz VHF/UHF (Ch21-60) Indoor (Bag B3)		10
404490	Flexible Coaxial Lead "IEC" Male-Female 0,1m Black (Blister S)	B	10
<b>COMBINERS</b> <span style="float:right">LTE790</span>			
<b>TERRESTRIAL</b>			
404010	Mast Triplexer 3i/1o "EasyF": BI/FM-BIII/DAB-UHF[dc]		1/10
404110	Mast Triplexer 3i/1o "EasyF": VHF-UHF[dc]-UHF		1/10
<b>TERRESTRIAL + 1 SATELLITE</b>			
745210	Mixer MATV-SAT 2i/1o "F": 47..790-950..2400MHz[dc]		1/10
745220	Mini-mixer MATV-SAT 2i/1o "F": 47..790-950..2400MHz[dc]		10
<b>TERRESTRIAL + 2 SATELLITES</b>			
740710	Double Mixer (47...790/950...2400MHz[dc]) 3i/2o "F": SAT1-MATV-SAT2 / SAT1+MATV-SAT2+MATV		1/10



▲ 404010

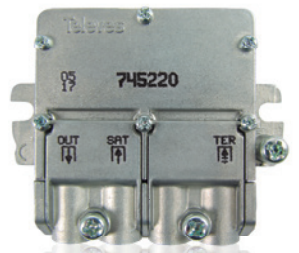

▲ Mini-mixer (745220)  
57 x 47 x 13 mm



▲ 745210

▲ 740710

**LTE FILTERS**

Attenuate the LTE/4G or LTE/5G signals passing through the antenna towards active devices susceptible of being affected by them.



"easyF" model



Plug-in model  
("F" or "IEC" connection)



Filter based on microcavities  
Minimal insertion losses

**LTE ADAPTATION ALL SOLUTIONS FOR ALL CASES**

# AMPLIFICATION

Ref.	Description		
<b>MAST AMPLIFICATION</b>			
<b>NANOKOM SERIES</b>			
561501	NanoKom Mast Amplifier 3i/1o "EasyF": BIII/UHF[dc]-FMmix-SATmix[dc] G 20/29- [-2] - [-2]dB Vo 105/107dBµV w/USOS 12...24V Powering (Switchable DC Pass)	LTE790	1/10
561620	NanoKom Mast Amplifier 3i/1o "EasyF": UHF[dc]-VHFmix-SATmix[dc] G 30- [-1] - [-2]dB Vo 107dBµV w/USOS. 12...24V Powering (Automatic LTE Filter & Switchable DC Pass)	LTE700 LTE790	1/10
561601	NanoKom Mast Amplifier 3i/1o "EasyF": UHF[dc]-VHFmix-SATmix[dc] G 30- [-1] - [-2]dB Vo 107dBµV w/USOS 12...24V Powering (Switchable DC Pass)	LTE790	1/10
561701	NanoKom Mast Amplifier 3i/1o "EasyF": UHF[dc]-UHF-VHFmix G 27-27- [-1]dB Vo 107dBµV 12...24V Powering (Switchable DC Pass)	LTE790	1/10
561801	NanoKom Mast Amplifier 3i/1o "EasyF": BIII-UHF[dc]-FMmix G 21-29- [-2]dB Vo 107dBµV w/USOS 12...24V Powering (Switchable DC Pass)	LTE790	1/10
<b>HIGH GAIN - HIGH OUTPUT LEVEL - 24V POWERING</b>			
<b>LTE790</b>			
535640	Mast Amplifier 1i/1o "EasyF": FM/BIII/DAB/UHF[dc] G 15/31/31/41dB Vo 116dBµV 24V Pow. (Switchable DC Pass)		1/5
535740	Mast Amplifier 3i/1o "EasyF": FM-BIII/DAB-UHF[dc] G 15-32/32-42dB Vo 116dBµV 24V Pow. (Switchable DC Pass)		1/5
535840	Mast Amplifier 4i/1o "EasyF": FM-BIII/DAB-UHF-UHF[dc] G 15-32/32-41-41dB Vo 116dBµV 24V Pow. (Switchable DC Pass)		1/5
<b>LOW GAIN - HIGH OUTPUT LEVEL - 12V POWERING</b>			
536040	Mast Amplifier 2i/1o "EasyF": BIII/DAB[dc]-UHF[dc] G 26/26/26-26dB Vo 114 dBµV 12V Pow. (Switchable DC Pass)		1/5
536041	Mast Amplifier 3i/1o "EasyF": BIII/DAB-UHF-UHF[dc] G 26/26-26-26dB Vo 114 dBµV 12V Pow. (Switchable DC Pass)		1/5
<b>SAT-MIX SERIES: VARIABLE GAIN - LOW OUTPUT LEVEL - 12...24V POWERING</b>			
5354	Mast Amplifier 2i/4o "EasyF": UHF/Vmix[dc]-SATmix[dc] G 20/[-9] - [-12]dB Vo 93dBµV 12...24V Pow.		1/5
<b>DOMESTIC POWER SUPPLY UNITS: PICOKOM SERIES</b>			
5795	PicoKom Domestic Power Supply Unit 1i/2o "EasyF": 5...862MHz 24V-130mA		1/10
5796	PicoKom Domestic Power Supply Unit 1i/1o "EasyF" SATmix: 5...2500MHz 12V-220mA		1/10
<b>DOMESTIC POWER SUPPLY UNITS</b>			
5504	Domestic Power Supply Unit 1i/2o "F" 5...862MHz 24V-130mA		1
550101	Domestic Power Supply Unit 1i/2o "F" 5...862MHz 12V-220mA		1
5501	Domestic Power Supply Unit 1i/2o "F" 5...862MHz 12V-220mA (UK Plug)		1
<b>KITS: MAST AMPLIFIER + PSU</b>			
<b>LTE790</b>			
568002	NanoKom Mast Amplifier 3i/1o "EasyF": UHF[dc]-UHF-VHFmix + PicoKom PSU 1i/2o "EasyF" 24V-130mA. Kit with Refs. 561701 & 5795	⊕	1
567802	NanoKom Mast Amplifier 3i/1o "EasyF": UHF[dc]-VHFmix-SATmix[dc] with USOS + PicoKom PSU 1i/1o "EasyF" 12V-220mA. Kit with Refs.: 561601 & 5796	⊕	1

## MAST NANOKOM SERIES



Dimensions: 90 x 80 x 38mm

The ultra-small size series with very low noise figure and automatic output level adjusting (USOS System).



▲ Mast Amplifier: 126 x 134 x 38 mm



▲ Domestic PSU: PicoKom Series 90 x 68 x 28 mm



▲ Domestic PSU: F Connector 145 x 35 x 45 mm

AMPLIFICATION

Ref.	Description		
<b>MATV DOMESTIC AMPLIFIERS (47...694/790/862MHz)</b>			
<b>"EasyF" CONNECTOR: NANOKOM SERIES</b>			<b>LTE790</b>
562701	NanoKom Domestic Amplifier 1i/1o "EasyF": 47...790/862MHz G 13/26dB Vo 98/106dBµV w/USOS + Preamp.Pow. 12V-150mA Switchable LTE Filter. Remote Powering (PSU included)		1/10
562702	NanoKom Domestic Amplifier 1i/2o "EasyF": 47...790/862MHz G 10/23dB Vo 95/103dBµV w/USOS + Preamp.Pow. 12V-150mA Switchable LTE Filter. Remote Powering (PSU included)		1/10
562703	NanoKom Domestic Amplifier 1i/(2o+TV) "EasyF": 47...790/862MHz G 9/22dB Vo 94/102dBµV w/USOS + Output TV Outlet G 13dB + Preamp.Pow. 12V-150mA Switchable LTE Filter. Remote Powering (PSU included)		1/10
562713	NanoKom Domestic Amplifier 1i/(2o+TV) "EasyF": 47...790/862MHz G 9/22dB Vo 94/102dBµV w/USOS + Output TV Outlet G 13dB + Preamp.Pow. 12V-150mA Switchable LTE Filter. Remote Powering (PSU not included)		1/10
<b>"EasyF" CONNECTOR: PICOKOM SERIES</b>			
560541	PicoKom Domestic Amplifier 1i/1o "EasyF": 47...790MHz G 12/24dB Vo 100/105dBµV Auto-Adjustment + Preamp.Pow. 12V-150mA	<b>LTE790</b>	1/10
560542	PicoKom Domestic Amplifier 1i/2o "EasyF": 47...790MHz G 10/20dB Vo 100/105dBµV Auto-Adjustment + Preamp.Pow. 12V-150mA	<b>LTE790</b>	1/10
560543	PicoKom Domestic Amplifier 1i/(2o+TV) "EasyF": 47...790MHz G 10/20dB Vo 100/105dBµV Auto-Adjustment + Preamp.Pow. 12V-150mA	<b>LTE790</b>	1/10
5605	PicoKom Domestic Amplifier 1i/2o "EasyF": 47...862MHz G 10/20dB Vo 105dBµV Auto-Adjustment + Preamp.Pow. 12V-150mA		1/10
<b>"IEC" CONNECTOR</b>			
552740	Domestic Amplifier 1i/1o "IEC": 47...790MHz G 25dB Vo 112dBµV (Blister T1)	<b>LTE790</b>	8
552741	Domestic Amplifier 1i/1o "IEC": 47...790MHz G 25dB Vo 112dBµV (UK plug)	<b>LTE790</b>	5
552120	Domestic Amplifier 1i/2o "IEC": 47...694MHz G 22dB Vo 104dBµV (Blister T1)	<b>LTE700</b>	8
552840	Domestic Amplifier 1i/(2o+TV) "IEC": 47...790MHz G 20dB Vo 106dBµV + Output TV Outlet G 12dB (Blister T1)	<b>LTE790</b>	8
5529	Domestic Amplifier 1i/(4o+TV) "IEC": 47...862MHz G 16dB Vo 102dBµV + Output to a TV Outlet G 11dB (Blister G)		8
552940	Domestic Amplifier 1i/(4o+TV) "IEC": 47...790MHz G 16dB Vo 102dBµV + Output to a TV Outlet G 11dB (Blister T1)	<b>LTE790</b>	8
545720	Domestic Amplifier 1i/(2o+TV) "IEC": 47...694MHz G 20dB Vs 110dBµV + Output TV Outlet G 12dB + Preamp.Pow. 12V-100mA (Blister T1)	<b>LTE700</b>	8
545740	Domestic Amplifier 1i/(2o+TV) "IEC": 47...790MHz G 20dB Vo 106dBµV + Output TV Outlet G12dB +Preamp.Power. 12V-100mA	<b>LTE790</b>	1
<b>"F" CONNECTOR</b>			
5519	Domestic Amplifier 1i/(1o+TV) "F": 47...320/470..862MHz G17/27dB Vo105dBµV + TV Output G -3/7dB		1
552220	Domestic Amplifier 1i/(2o+TV) "F": 47...694MHz G 20dB Vo 110dBµV + Output TV Outlet G 12dB (Blister T1)	<b>LTE700</b>	1
552240	Domestic Amplifier 1i/(2o+TV) "F": 47...790MHz G 20dB Vo 106dBµV + Output to a TV Outlet G 12dB (Blister T1)	<b>LTE790</b>	8
5523	Domestic Amplifier 1i/(4o+TV) "F": 47...862MHz G 16dB Vo 102dBµV + Output to a TV Outlet G 11dB (Blister T1)		8
552340	Domestic Amplifier 1i/(4o+TV) "F": 47...790MHz G 16dB Vo 102dBµV + Output to a TV Outlet G 11dB (Blister T1)	<b>LTE790</b>	8
5531	Domestic Amplifier 1i/6o "F": 47...862MHz G 16dB Vo 103dBµV (Blister T1)		8

DOMESTIC NANOKOM SERIES



Dimensions: 64 x 45 x 28 mm

The discreet and ultra-small size range with automatic level adjusting (USOS System) and the possibility to be powered remotely.



SCAN TO WATCH THE VIDEO  
EN.TELEVES.COM/NANOKOM

A00328

easyF



▲ Domestic Amplifier: PicoKom Series  
90 x 68 x 28 mm



▲ Domestic Amplifier: "IEC" Connector  
145 x 35 x 45 mm

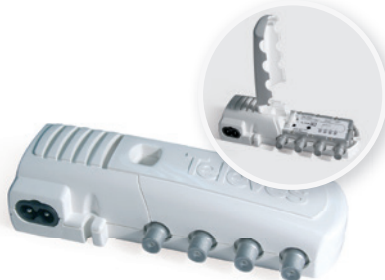

▲ Domestic Amplifier: "F" Connector  
145 x 35 x 45 mm

# AMPLIFICATION

Ref.	Description	
<b>SMATV DOMESTIC AMPLIFIERS (47...2150MHz)</b>		
<b>"EasyF" CONNECTOR: PICOKOM SERIES</b>		
560601	PicoKom Domestic Amplif. 1i/2o "EasyF": 47..862/950..2150MHz G 15/23dB Vo 97/106dBµV AGC +Preamplifier Powering 12V-160mA	1/10
<b>"F" CONNECTOR</b>		
5530	Domestic Amplifier 1i/(2o+TV) "F": 5..30/47..862/950..2150MHz G(-9)/18/20dB Vo 105/110dBµV +Output TV Outlet G(-16)/10/12dB (Blister T1)	8
<b>CATV DOMESTIC AMPLIFIERS (5...862MHz)</b>		
<b>"F" CONNECTOR</b>		
5520	Domestic Amplifier 1i/(2o+TV) "F": 5..65/87.5..862MHz G -7/20dB Vo107dBµV +Output TV Outlet G13dB (Passive Return)	8
5525	Domestic Amplifier 1i/(2o+TV) "F": 5..65/87.5..862MHz G -7/18dB Vo106dBµV + Output TV Outlet G 12dB (Passive Ret.+ Equaliser)	8
5526	Domestic Amplifier 1i/(2o+TV) "F": 5..65/87.5..862MHz G 9/20dB Vo 107dBµV +Output TV Outlet G13dB (Active Return)	8
553301	Domestic Amplifier 1i/1o "F": 5..30/47..862MHz G -2/24dB Vo 112dBµV (Passive Ret.+ Equaliser)	8
553501	Domestic Amplifier 1i/1o "F": 5..30/47..862MHz G -2/34dB Vo 112dBµV (Passive Ret.+ Equaliser)	8
<b>SKY PASS AMPLIFIERS</b>		
<b>"F" CONNECTOR</b>		
5517	Domestic Amplifier 2i/4o "F": 47..232-5..30/470..862MHz G 16-6/16dB Vo 108-110/105dBµV 11V-10mA Sky Power. (UK Plug) <sup>(1)</sup>	1/5
<b>AMPLIFIERS: MINIKOM "EasyF" SERIES <span style="float: right;">LTE790</span></b>		
<b>TERRESTRIAL - MATV</b>		
562501	MiniKom Amplifier MATV 3i/1o "EasyF": FM-VHF-UHF G 15-[22  32]-[30  40]dB Vo 113-114-117dBµV Preamplif.Powering 12V-200mA (Switchable DC Pass)	1
562401	MiniKom Amplifier MATV 4i/1o "EasyF": FM-VHF-UHF-UHF G 15-[22  32]-[26  36]-[26  36]dB Vo 113-114-117-117dBµV Preamplif.Powering 12V-200mA (Switchable DC Pass)	1
562301	MiniKom Amplifier 5i/1o "EasyF": FM-V-U-21..35-39..60 G 15-[22  32]-[26  36]-[24  34]-[24  34]dB Vo113-114-117-117-117dBµV Preamp.Powering 12V-200mA (Switchable DC Pass)	1
562302	MiniKom Amplifier 5i/1o "EasyF": FM-V-U-21..32-36..60 G 15-[22  32]-[26  36]-[24  34]-[24  34]dB Vo113-114-117-117-117dBµV Preamp.Powering 12V-200mA (Switchable DC Pass)	1
<b>TERRESTRIAL + SATELLITE - SMATV</b>		
562601	MiniKom Amplifier MATV+SAT 4i/1o "EasyF": FM-VHF-UHF-SAT G 15-[21  31]-[27  37]-35dB Vo 114-114-115-119dBµV Preamplif.Powering 12V-200mA (Switchable DC Pass)	1
562201	MiniKom Amplifier MATV+SAT 5i/1o "EasyF": FM-VHF-UHF-UHF-SAT G 15-[21  31]-[24  34]-[24  34]-35dB Vo 114-114-115-115-119dBµV Preamplif.Powering 12V-200mA (Switchable DC Pass)	1

## MINIKOM EasyF SERIES

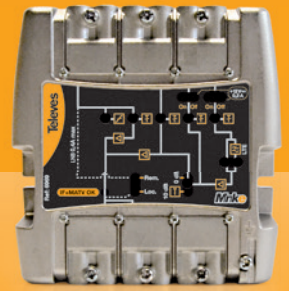

▲ Amplifiers

Dimensions: 100 x 100 x 50 mm

High efficiency launch / splitband amplifiers, with selectable gain and LTE rejection.



SCAN TO WATCH THE VIDEO  
EN.TELEVES.COM/MINIKOM



▲ Domestic Amplifier: "F" Connectors  
145 x 35 x 45 mm

(1) Variable gain in UHF and VHF with detachable main lead.



Ref.	Description	
<b>AMPLIFIERS: MINIKOM "F" SERIES</b>		
<b>TERRESTRIAL - MATV: LINE</b>		
537302	MiniKom Amplifier MATV 1i/1o "F": 47...454/470...862MHz G [20][30]/[27][37]dB Vo 114/116dB $\mu$ V	1
<b>TERRESTRIAL - MATV</b>		
539201	MiniKom Amplifier MATV 4i/1o "F": FM-BIII/DAB-UHF-UHF G 15-[20][30]-[27][37]-[27][37]dB Vo 114-114-117-117dB $\mu$ V 12V-70mA Preamp.Pow.	1
<b>RETURN PATH + TERRESTRIAL + SATELLITE - SMATV/CATV: LINE</b>		
531710	MiniKom Amplifier Return Path + MATV + SAT 1i/1o "F": 5..30/47..862/950..2150MHz G -5/30/33..38dB Vo (MATV/SAT) 114/123dB $\mu$ V	1
<b>RETURN PATH + TERRESTRIAL + SATELLITE - SMATV/CATV</b>		
5317	MiniKom Amplifier Return Path + MATV + 2SAT 2i/2o "F": (5..30/47..862/950..2150)-(950..2150)MHz G (for 2 outputs) -5/30/33..38dB Vo (MATV/SAT) 114/123dB $\mu$ V	1
<b>TERRESTRIAL + SATELLITE - SMATV</b>		
5396	MiniKom Amplifier MATV + SAT 4i/1o "F": BI/FM-BIII-UHF-FI G 33/20-35-40-35...42dB Vo 112-112-115-121dB $\mu$ V 12V-70mA Preamplif.Pow.	1
5363	MiniKom Amplifier MATV + SAT 2i/1o "F": (47...862)-(950...2150)MHz G -1.5-35..45dB Vo(SAT) 124dB $\mu$ V	1
536310	MiniKom Amplifier MATV + SAT 2i/1o "F": (47...862)-(950...2150)MHz G -1.5-35..45dB Vo(SAT) 124dB $\mu$ V (110Vac & US Plug)	1
<b>SKY PASS - TERRESTRIAL - MATV</b>		
5372	MiniKom Amplifier Return Path + MATV 2i/(7+1)o "F": FM/VHF-5..7MHz/UHF G 5-0.5/15dB Vo 89-108/89dB $\mu$ V (+10[16-15/27dB) 12V 30/10mA Preamplif./IR Powering (UK Plug)	1
<b>AMPLIFIERS: DTKOM SERIES</b>		
<b>TERRESTRIAL - MATV: LINE</b>		
5338	DTKom Amplifier MATV 1i/1o "F": 47...862MHz G [41][53]dB Vo 123dB $\mu$ V (Remote Powering)	1
<b>TERRESTRIAL - MATV</b>		
534040	DTKom Amplifier MATV 3i/1o "F": FM-BIII-UHF G [21][25]-[36][44]-[45][55]dB Vo 123dB $\mu$ V 12V-50mA Preamplif. Powering	LTE790 1
5341	DTKom Amplifier MATV 5i/1o "F": BI/FM-BIII-21..36-38..69-UHF G [31][39]/[21][25]-[36][44]-[39][48]-[40][50]-[40][50]dB Vo 123dB $\mu$ V 12V-50mA Preamplif. Powering	1
534140	DTKom Amplifier MATV 5i/1o "F": FM-BIII-21..35-38..60-UHF G [21][25]-[36][44]-[40][50]-[42][52]-[42][52]dB Vo 123dB $\mu$ V 12V-50mA Preamplif. Powering	LTE790 1
534141	DTKom Amplifier MATV 5i/1o "F": FM-BIII-21..32-36..60-UHF G [21][25]-[36][44]-[40][50]-[42][52]-[42][52]dB Vo 123dB $\mu$ V 12V-50mA Preamplif. Powering	LTE790 1
4508	DTKom Amplifier MATV 4i/1o "F": FM-VHF-UHF-UHF G 30-[32][45]-[40][52]-[40][52]dB Vo 129dB $\mu$ V 12V-70mA Preamp.Pow.	1
4509	DTKom Amplifier 5i/1o "F": FM-VHF-21..35-39..69-UHF G 30-[32][45]-[38][50]-[38][50]-[40][52]dB Vo 129dB $\mu$ V 12V-70mA Preamp.Pow.	1
<b>RETURN PATH + TERRESTRIAL + SATELLITE - SMATV/CATV: LINE</b>		
533501	DTKom Amplifier Return Path + MATV + SAT 1i/1o "F": 5..65/87..862/950...2150MHz G 20/[40][53]/42dB Vo 115/124/121dB $\mu$ V	1
5337	DTKom Amplifier Return Path + MATV + 2SAT 2i/2o "F": (5..30/47..862/950..2150MHz) - (950..2150MHz) G (for 2 outputs) [-5][17]/[34][47]/42dB Vo 113/120/120dB $\mu$ V	1
<b>RETURN PATH + TERRESTRIAL - CATV: LINE</b>		
451203	DTKom Amplifier Return Path + MATV 1i/1o "F": 5...65/87...1006MHz G 28/[30][40]dB Vo 118/129dB $\mu$ V	1



▲ Amplifiers: MiniKom "F" Series  
185 x 112 x 70 mm



▲ Amplifiers: DTKom Series  
284 x 140 x 50 mm

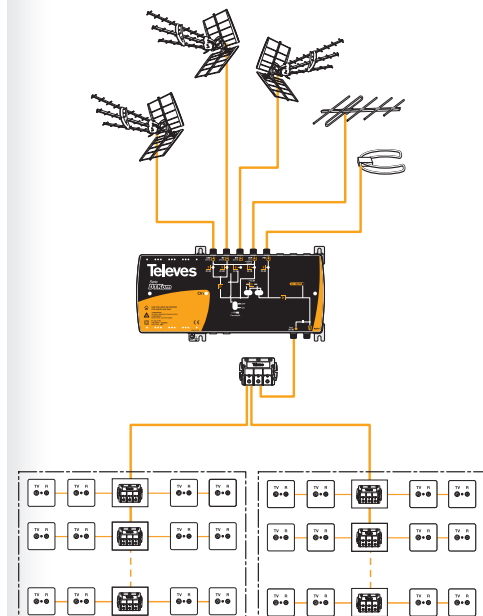

# AMPLIFICATION

Ref.	Description	
<b>AMPLIFIERS: OUTDOOR SERIES</b>		
<b>RETURN PATH + TERRESTRIAL - CATV</b>		
451310	Outdoor Amplifier Return Path + MATV 35...90Vac Powered 1i/1o 5/8": 5...65/87...1006MHz G (-  28)/(30  40)dB Vo 128/118dB $\mu$ V (Passive/Active Return Path)	1
4513	Outdoor Amplifier Return Path + MATV 40...60Vac Powered 1e/1s 5/8": 5...65/87.5...862MHz G 12/(26  36)dB Vo 118 dB $\mu$ V (Active Return Path)	1
5456	Outdoor Power Supply Unit 57Vac - 5A	1
<b>AMPLIFIERS: MICROKOM SERIES</b>		
<b>MODULAR RETURN PATH AMPLIFIERS</b>		
534602	MicroKom Amplifier Return Path + MATV 1i/1o "F": 5...65/85...862MHz G 20/20dB Vo 118/118dB $\mu$ V	1
534702	MicroKom Amplifier Return Path + MATV 1i/1o "F": 5...65/85...862MHz G 20/24dB Vo 118/118dB $\mu$ V	1
<b>ACCESSORIES: RETURN PATH MODULES</b>		
455320	MicroKom Return Path Module + MATV 1i/1o "F": 5...65/85...862MHz G 20/- dB Vo 118dB $\mu$ V	1/10
455325	MicroKom Return Path Module + MATV 1i/1o "F": 5...65/85...862MHz G 25/- dB Vo 118dB $\mu$ V	1/10
455328	MicroKom Return Path Module + MATV 1i/1o "F": 5...65/85...862MHz G 28/- dB Vo 118dB $\mu$ V	1/10
<b>FIXED RETURN PATH AMPLIFIERS</b>		
534211	MicroKom Amplifier Return Path + MATV 1i/1o "F": 5...65/85...1006MHz G G(-  20)/(20  25)dB Vo 118/121 dB $\mu$ V	1
534411	MicroKom Amplifier Return Path + MATV 1i/1o "F": 5...65/85...1006MHz G (-  20)/(28  35)dB Vo 118/121 dB $\mu$ V	1



▲ Amplifiers: Outdoor Series  
290 x 220 x 100 mm



▲ Amplifiers: MicroKom Series  
190 x 88 x 35 mm

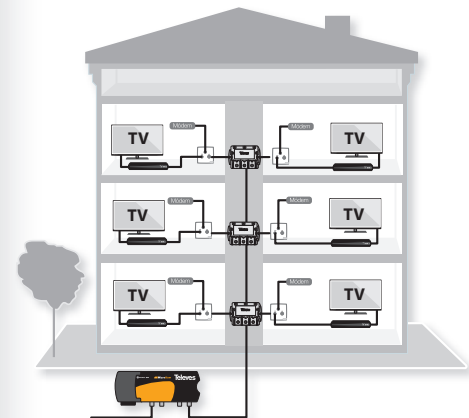
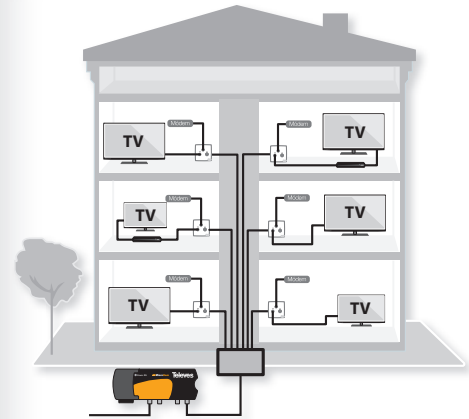

**Headend + CATV amplifiers & outdoor passive elements**

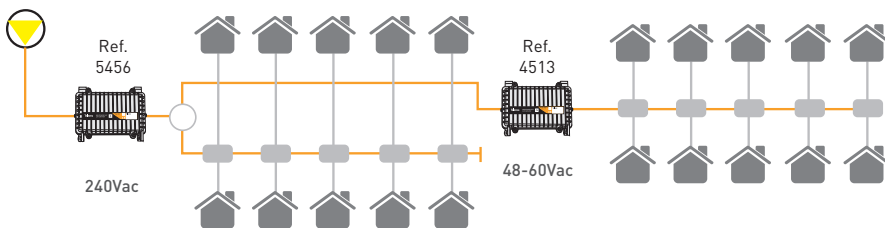

**AMPLIFICATION**

Ref.	Description		
<b>PROGRAMMABLE AMPLIFICATION: AVANT SERIES</b>			
<b>AVANT 3</b>			
532740	Avant 3: Programmable Amplifier (5 Filters AGC) 5i/2o "F": BI/FM-VHF-2UHF-INmix G 32/15-35-50-3dB Vo 114-114-116-114/116dBμV	LTE790	1
<b>AVANT 9 (1)</b>			
532001	Avant 9 Basic: Programmable Amplifier (10 Filters). 5i/1o "F": FM-BIII/DAB-(120..862)-2xUHF G 34-49-41-55dB Vo 122-122-122-122dBμV	LTE790	1
532011	Avant 9 Basic-Sat: Programmable Amplifier (10 Filters). 6i/2o "F": FM-BIII/DAB-(120..862)-2xUHF-SAT G 34-49-41-51-45dB Vo 118-118-118-118-123dBμV	LTE790	1
532021	Avant 9 Pro: Programmable Amplifier (10 Filters). 6i/1o "F": FM-BIII/DAB-(120..862)-3xUHF G 30-45-37-55dB Vo 122-122-122-122dBμV With Autoprogramming, Monitoring and Report Generation	LTE790	1
532022	Avant 9 Pro with Auto-LTE: Programmable Amplifier (10 Filters). 6i/1o "F": FM-BIII/DAB-(120..862)-3xUHF G 30-45-37-55dB Vo 122-122-122-122dBμV With Autoprogramming, Monitoring and Report Generation	LTE790 LTE700	1
532031	Avant 9 Pro-Sat: Programmable Amplifier (10 Filters). 7i/2o "F": FM-BIII/DAB-(120..862)-3xUHF-SAT G 30-45-37-51-45dB Vo 118-118-118-118-123dBμV With Autoprogramming, Monitoring and Report Generation	LTE790	1
<b>ACCESSORIES</b>			
7234	Universal Programmer T.0X/T05/AVANT		1
5750	Cabinet for Headend Amplifier 440x440x140mm		1
400610	Line Amplifier UHF 1i/1o "F": 470...790MHz G 13dB Vo 98dBμV (Plug-in)		1/10
4007	Notch Filter "F" UHF (C21-69) 1 Channel & 1 Adjustment		1/10
4162	Notch Filter "IEC" BI/FM/BIII/UHF 2 Channels & 2 Adjustments		1/10
4947	Coaxial Atmospheric Surge Arrestor 90V 0...3GHz		1/20
4061	Terminal Load "F" 750hm with DC Blocked		10/200



▲ Programmable Amplification: Avant 3  
198 x 119 x 65 mm



▲ 5750  
Cabinet for Headend Amplifier (440 x 440 x 140mm)

(1) OTG cable for an ASuite programming included in all the AVANT 9 versions.

**BEYOND YOUR EXPECTATIONS**

CHOOSE THE PROGRAMMING MODE YOU WISH...



**Avant 9**

PROGRAMMABLE HEADEND AMPLIFIER

**SMALL AND LIGHT-WEIGHT**  
(273 x 203 x 57 mm)



**HIGH REJECTION TO ADJACENT CHANNELS**



**25% REDUCTION IN POWER CONSUMPTION**



**MANUFACTURED IN EUROPE**



SCAN TO WATCH THE VIDEO



EN.TELEVES.COM/AVANT9

WITH OUR CLASSIC UNIVERSAL PROGRAMMER

A SIMPLE AND INTUITIVE APPLICATION FOR ANDROID AND PC USB connection (OTG cable)

PERFORM AUTOMATIC PROGRAMMING WITH A SINGLE BUTTON\*

PDF Report Production\*

\* (PRO VERSION)

Ref.	Description	
<b>T12 SERIES</b>		
<b>SINGLE CHANNEL AMPLIFICATION</b>		<b>LTE790</b>
508212	T12 Single Channel Amplifier FM 88..108MHz G 35dB Vo 114dBμV	1
508712	T12 Single Channel Amplifier S-Low Band 104...174MHz G 58dB Vo 125dBμV	1
508312	T12 Single Channel Amplifier BIII 174...230MHz G 45dB Vo 123dBμV	1
509912	T12 Single Channel Amplifier DAB 195...232MHz G45dB Vo114dBμV	1
508812	T12 Single Channel Amplifier S-High Band 230...300MHz G 58dB Vo 124dBμV	1
508912	T12 Single Channel Amplifier HyperBand 302...470MHz G 58dB Vo 125dBμV	1
508612	T12 Single/Multi Channel Amplifier UHF DTT 470...862MHz G 50dB Vo 125dBμV (Up to 5 Channels)	1
509712	T12 Single Channel Amplifier DTT UHF 470...862MHz G 57dB Vo 125dBμV w/Automatic Adjustment	1
509812	T12 Single Channel Amplifier High Selectivity UHF 470...862MHz G 55dB Vo 125dBμV	1
509512	T12 Single Channel Amplifier High Selectivity UHF 470...862MHz G 52dB Vo 121dBμV w/Automatic Adjustment	1
508012	T12 Amplifier SAT 950...2150MHz G 35...50dB Vo 124dBμV	1
<b>POWER SUPPLY UNITS</b>		
549812	T12 Switch-mode Power Supply Unit 60W 24V-2.5A	1
<b>SUPPORTS &amp; ENCLOSURES</b>		
5071	Wall Mount 498mm (1 PSU + 7 T.OX Modules or 10 T12/T05 Modules) <sup>(1)</sup>	1
5239	Wall Mount 560mm (1 PSU + 8 T.OX Modules or 12 T12/T05 Modules) <sup>(1)</sup>	1
5301	19" Rack Frame 5RU (1 PSU + 7 T.OX Modules or 10 T12/T05 Modules) <sup>(1)</sup>	1
5072	Lockable Cabinet 498mm (1 PSU + 10 Modules T12/T05) <sup>(1)</sup>	1
5069	Lockable Cabinet 648mm (1 PSU + 14 T12/T05 Modules) <sup>(1)</sup>	1
5333	19" Rack Cabinet 15RU. Ventilation, Wheels, Glazed Door	1
5331	19" Rack Cabinet 28RU. Ventilation, Wheels, Glazed Door	1
5332	19" Rack Cabinet 37RU. Ventilation, Wheels, Glazed Door	1
<b>ACCESSORIES</b>		
400610	Line Amplifier UHF 1i71o "F": 470...790MHz G 13dB Vo 98dBμV (Plug-in)	1/10
4007	Notch Filter "F" UHF (Ch21-69) 1 Channel & 1 Adjustment	1/10
4162	Notch Filter BI/FM/BIII/UHF 2 Channels & 2 Adjustments "IEC"	1/10
5165	Adjustable Attenuator "IEC" 0 to 20dB 40..860MHz DC Pass	10
4005	Adjustable Attenuator "F" 0 to 20dB 5...2200MHz DC Pass	1/10
507312	T12/T05 Blank Plate 35mm - 5RU	1
5074	T12 "F" Connector Link Push Fit Type, 48mm	10
4061	Terminal Load "F" 75ohm with DC Blocked	10/200
4071	DC Blocker "F"	10
4947	Coaxial Atmospheric Surge Arrestor 90V 0...3GHz	1/20



▲ 509812

▲ 508012



▲ 5301

▲ 549812



▲ 5069 / 5072

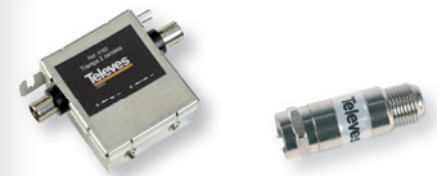

▲ 4162

▲ 4071



▲ 400610

(1) The number of modules indicated is based solely on the available space; but the number of installable modules may be limited by other restrictions as consumption or temperature.



## TWO MODULES IN ONE

CONTENT IP STREAMER OR IP/AV TO RF MODULATOR



### T.OX ENCODER TWIN IP (REF. 563852)

- Two operating modes: AV - IP/RF or IP/ AV - RF
- High output signal power without additional amplification
- DVB-T and DVB-C output or configurable IP
- Energy efficient due to its low power consumption



HDTV



REMOTE  
MANAGEMENT



LOW  
CONSUMPTION



H.264  
STANDARD

Ref.	Description	
<b>T.OX SERIES</b>		
<b>SMATV HEADENDS</b>		
563101	T.OX Transmodulator DVBS/S2-COFDM (47...862MHz)	1
563301	T.OX Transmodulator DVBS/S2-COFDM CI (47...862MHz) <sup>(1)</sup>	1
564201	T.OX Transmodulator DVBS/S2-COFDM CI (47...862MHz) Multiplexer: 3 Transponders(2Sat):1Ch or 3 Transponders(1Sat+LoopThru): 1Ch <sup>(1)</sup>	1
564230	T.OX Transmodulator DVBS/S2-COFDM CI Re-encryption (47...862MHz) Multiplexer: 3 Transponders(2Sat): 1 Ch or 3 Transponders(1Sat+LoopThru): 1 Ch <sup>(1)</sup>	1
564301	T.OX Twin Transmodulator DVBS/S2-COFDM CI (47...862MHz) Multiplexer: 3 Transponders(2Sat):2Ch or 3 Transponders(1Sat+LoopThru): 2Ch <sup>(1)</sup>	1
563001	T.OX Twin Transmodulator DVBS/S2-QAM (47...862MHz)	1
564501	T.OX Hexa Transmodulator DVBS/S2-QAM (47...862MHz)	1
563501	T.OX Transmodulator DVBS/S2-QAM CI (47...862MHz) <sup>(1)</sup>	1
564101	T.OX Transmodulator DVBS/S2-QAM CI (47...862MHz) Multiplexer: 3 Transponders(2Sat):1Ch or 3 Transponders(1Sat+LoopThru): 1Ch <sup>(1)</sup>	1
564130	T.OX Transmodulator DVBS/S2-QAM CI Re-encryption (47...862MHz) Multiplexer: 3 Transponders(2Sat): 1 Ch or 3 Transponders(1Sat+LoopThru): 1 Ch <sup>(1)</sup>	1
564401	T.OX Twin Transmodulator DVBS/S2-QAM CI (47...862MHz) Multiplexer: 3 Transponders(2Sat):2Ch or 3 Transponders(1Sat+LoopThru): 2Ch <sup>(1)</sup>	1
553701	T.OX Twin Transmodulator QPSK-PAL CI Stereo (VSB 47...862MHz) <sup>(1)</sup>	1
553702	T.OX Twin Transmodulator QPSK-PAL CI Stereo (VSB 47...862MHz) Pro CAM compatible. Simultaneous decryption of 2 services <sup>(1) (2)</sup>	1
<b>MATV HEADENDS</b>		
566001	T.OX Encoder/Modulator Single 1i: HDMI / Component(YPbPr) / CVBS - 1Mux: COFDM/QAM (MPEG2/4) (Standalone support + PSU 18V included)	1
566011	T.OX Encoder/Modulator Twin, 2i: CVBS - 1Mux: COFDM/QAM (MPEG2) (Standalone Support + PSU18V included)	1
563822	T.OX Encoder/Modulator Quad, 4i A/V: CVBS - 1Mux: COFDM/QAM (MPEG2/4)	1
563832	T.OX Encoder/Modulator Twin, 2i: HDMI / Component (YPbPr) - 1Mux: COFDM/QAM (MPEG2/4)	1
563833	T.OX Encoder/Modulator Twin, 2i: HDMI / Component (YPbPr) - 1Mux: ISDB-Tb/DVB-T (MPEG2/4)	1
563852	T.OX Encoder/Modulator IP Twin (MPEG2/4), 2 Modes: 2i: HDMI / Component(YPbPr) / CVBS - 1Mux: IP/COFDM/QAM 2i: HDMI / Component(YPbPr) / CVBS / IP - 1Mux: COFDM/QAM	1
565101	T.OX Twin Transmodulator DVBT/T2-COFDM CI (47...862MHz) Multiplexer: 2 Channels (DVB-T/T2): 2 Channels (DVB-T) <sup>(1)</sup>	1
565201	T.OX Twin Transmodulator DVBT/T2-QAM CI (47...862MHz) Multiplexer: 2 Channels (DVB-T/T2): 2 Channels (DVB-T) <sup>(1)</sup>	1
564901	T.OX Twin Processor Analogue/Digital Channel (47...862MHz)	1
5806	T.OX Twin Modulator Analogue A/V-PAL Stereo (VSB 47...862MHz)	1
<b>POWER SUPPLY UNITS</b>		
562802	Power Supply Unit 38.4W 24V-1.6A (T.OX standalone mounting)	1
562910	T.OX Switch-mode Power Supply Unit 60W 24V-2.5A	1
5629	T.OX Switch-mode Power Supply Unit 120W 24V-5A	1
563901	T.OX Switch-mode Power Supply Unit 120W 24V-5A (110Vac & UL Listed)	1
<b>AMPLIFIER</b>		
5575	T.OX Amplifier Push-Pull 47...862MHz G 44dB Vo 120dBuV	1
<b>COMBINER</b>		
565002	Combiner 7i/1o: 5...1002MHz, 19" Rack Mount, 1RU	1
<b>REMOTE CONTROL, PROGRAMMER &amp; SW</b>		
5559	T.OX Headend Management Unit CDC IP	1
555901	T.OX Headend Management Control CDC IP/GSM	1
7234	Universal Programmer T.OX/T05/AVANT	1
216801	Kit: PC-Module Cable & USB-Serial Adapter Utilities: TSuite (T.OX, T05)	1



▲ 564401 ▲ 564301



▲ T.OX Encoders

Generate your own DTT content in High Definition.



▲ 565201 ▲ 565101



▲ 565002

(1) In case of modules with CI, it is the responsibility of the concerned person to consult Televés and check compatibility of CAM and card with the module.

(2) If CAM and card allow it.

**PROCESSING HEADENDS**

Ref.	Description	
<b>T.OX SERIES</b>		
<b>SUPPORTS &amp; ENCLOSURES</b>		
567401	Standalone Support (1 T.OX Module)	1
5071	Wall Mount 498mm (1 PSU + 7 T.OX Modules or 10 T12/T05 Modules) <sup>(1)</sup>	1
5239	Wall Mount 560mm (1 PSU + 8 T.OX Modules or 12 T12/T05 Modules) <sup>(1)</sup>	1
5301	19" Rack Frame 5RU (1 PSU + 7 T.OX Modules or 10 T12/T05 Modules) <sup>(1)</sup>	1
567201	Rack Support 275mm 5RU (1 PSU + 4 T.OX Modules)	1
507202	Lockable Cabinet with Forced Ventilation 498mm (1 PSU + 7 T.OX Modules) <sup>(1)</sup>	1
5333	19" Rack Cabinet 15RU. Ventilation, Wheels, Glazed Door	1
5331	19" Rack Cabinet 28RU. Ventilation, Wheels, Glazed Door	1
5332	19" Rack Cabinet 37RU. Ventilation, Wheels, Glazed Door	1
<b>ACCESSORIES</b>		
5673	T.OX Blank Plate 50mm - 5RU	1
533153	T.OX Panel for Rack 19" 1RU, Up to 2x7 "F" connectors	1
567250	CAM Protection Bar (for Ref. 567201)	1
4061	Terminal Load "F" 750hm with DC Blocked	10/200
4071	DC Blocker "F"	10
4947	Coaxial Atmospheric Surge Arrestor 90V 0...3GHz	1/20
422601	Patch Cable for Powering T.OX from T05 0.4m	1/5
<b>WALL MOUNT</b>		
585901	Analogue Modulator Quad PAL B/G with channel display (VHF/UHF) Wall mount (Connection accessories included)	1
<b>MODULATOR + ENCODERS (RACK MOUNT)</b>		
718201	Chassis with Double Power Supply, 6 Slots for slot-in Encoder/Modulator. 19" Rack Mount, 1RU	1
718210	Slot-in Encoder/Modulator IP - COFDM (8Mux)	1
718220	Slot-in Encoder/Modulator IP - QAM (16Mux)	1



567401



5071



5301



422602



▲ Pre-assembled Rack Cabinet (on request)



▲ 567250

567201



▲ 507202 (T.OX units not included)



▲ 718201



▲ 585901

(1) The number of modules indicated is based solely on the available space; but the number of installable modules may be limited by other restrictions as consumption or temperature.

Ref.	Description	
<b>T.OX SERIES</b>		
<b>TRANSMISSION &amp; RECEPTION</b>		
233306	T.OX Optical Transmitter SMATV 1310nm "SC/APC" Po 6dBm w/o Return Path	1
233311	T.OX Optical Transmitter SMATV 1310nm "SC/APC" Po 10dBm w/o Return Path	1
234801	T.OX Optical Transmitter CATV 1310nm "SC/APC" Po 10dBm w/o Return Path RF Automatic Adjustment and Temperature Stability	1
234305	T.OX Optical Transmitter SMATV 1550nm "SC/APC" Po 4dBm w/o Return Path	1
234806	T.OX Optical Transmitter MATV 1550nm "SC/APC" Po 6dBm w/o Return Path External modulation and RF Automatic Adjustment (up to 30KHz)	1
234811	T.OX Optical Transmitter CATV 1550nm "SC/APC" Po 10dBm w/o Return Path RF Automatic Adjustment and Temperature Stability	1
2335	T.OX Optical Receiver SMATV 1200...1600nm "SC/APC" w/o Return Path	1
2336	T.OX Optical Receiver SMATV 1200...1600nm "SC/APC" with Return Path Optical Transmitter 1310nm Po 3dBm	1
234901	T.OX Return Path Optical Receiver (5...300MHz) 1270...1650nm "SC/APC", with AGC	1
<b>SPLITTERS</b>		
2337	T.OX Optical Splitter 1260...1650nm "SC/APC" 2W 4dB	1
2339	T.OX Optical Splitter 1260...1650nm "SC/APC" 4W 7dB	1
234401	T.OX Optical Splitter 1260...1650nm "SC/APC" 8W 10dB	1
234501	T.OX Optical Splitter 1260...1650nm "SC/APC" 16W 14dB	1
234601	T.OX Optical Splitter 1260...1650nm "SC/APC" 32W 17dB	1
<b>POWER SUPPLY UNITS</b>		
562910	T.OX Switch-mode Power Supply Unit 60W 24V-2.5A	1
5629	T.OX Switch-mode Power Supply Unit 120W 24V-5A	1
563901	T.OX Switch-mode Power Supply Unit 120W 24V-5A (110Vac & UL Listed)	1
<b>AMPLIFIERS</b>		
234221	T.OX Optical Amplifier / Multiplexer "SC/APC" 19dBm (EDFA Technology) 2i: 1310/1490nm - 1550nm, 1o: 1310/1490/1550nm	1
234228	T.OX Optical Amplifier / Multiplexer "SC/APC" 20dBm (YEDFA Technology) 9i: 8x1310/1490nm - 1x1550nm, 8o: 8x1310/1490/1550nm	1
<b>MULTIPLEXER / DEMULTIPLEXER (WDM)</b>		
234701	T.OX Optical Multiplexer / Demultiplexer 1i/2o "SC/APC": GPON+RF: Data (1310/1490nm) - TV (1550nm)	1
234702	T.OX Optical Multiplexer / Demultiplexer 1i/2o "SC/APC": RFoG: Uplink (1610nm) - Downlink (1550nm)	1
<b>SUPPORTS &amp; ENCLOSURES</b>		
5071	Wall Mount 498mm (1 PSU + 7 T.OX Modules or 10 T12/T05 Modules) <sup>(1)</sup>	1
5239	Wall Mount 560mm (1 PSU + 8 T.OX Modules or 12 T12/T05 Modules) <sup>(1)</sup>	1
5301	19" Rack Frame 5RU (1 PSU + 7 T.OX Modules or 10 T12/T05 Modules) <sup>(1)</sup>	1
507202	Lockable Cabinet with Forced Ventilation 498mm (1 PSU + 7 T.OX Modules) <sup>(1)</sup>	1
5333	19" Rack Cabinet 15RU. Ventilation, Wheels, Glazed Door	1
5331	19" Rack Cabinet 28RU. Ventilation, Wheels, Glazed Door	1
5332	19" Rack Cabinet 37RU. Ventilation, Wheels, Glazed Door	1
<b>ACCESSORIES</b>		
5673	T.OX Blank Plate 50mm - 5RU	1
4061	Terminal Load "F" 75Ohm with DC Blocked	10/200
4071	DC Blocker "F"	10
4947	Coaxial Atmospheric Surge Arrestor 90V 0...3GHz	1/20



▲ 234806 ▲ 234801/234811



▲ 234401 ▲ 234501 ▲ 234601



▲ 234221 ▲ 234228



▲ 234701 ▲ 234702



▲ 5629 ▲ 562910

(1) The number of modules indicated is based solely on the available space; but the number of installable modules may be limited by other restrictions as consumption or temperature.



Ref.	Description	
<b>F.O. DISTRIBUTION (Stand alone Transmitters and Optical Nodes)</b>		
<b>OPTICAL TRANSMITTERS: FIBERKOM SERIES</b>		
238201	Fiberkom Optical Transmitter SMATV 1310nm "SC/APC" Po 3dBm 47..2200MHz	1
<b>OPTICAL NODES</b>		
231020	Outdoor Optical Node 1200...1600nm "SC/APC" Return Path 1610nm with Amplifier 2o: 87...1006MHz, OLC Technology (Local Powering) <sup>(1)</sup>	1
231220	Outdoor Optical Receiver 1200...1600nm "SC/APC" without Return Path with Amplifier 2o: 40...1006MHz, OLC Technology (Local Powering) <sup>(1)</sup>	1
2310	Outdoor Optical Node 1200...1600nm "SC/APC" Return Path 1310nm with Amplifier 1o: 87...862/950...2150MHz (Local Powering)	1
231201	Outdoor Optical Receiver 1200...1600nm "SC/APC" without Return Path with Amplifier 1o: 87...862/950...2150MHz (Local Powering)	1
<b>OPTICAL MINI-NODES: FIBERKOM SERIES</b>		
238001	FiberKom Optical Mini-node 1200...1600nm "SC/APC" Return Path 1310nm (2 Fibers) with Amplifier 87...1218MHz, OLC Technology (Local Powering) <sup>(1)</sup>	1
238004	FiberKom Optical Mini-node 1550nm "SC/APC" Return Path 1610nm (1 Fiber) with Amplifier 105...1218MHz DOCSIS 3.0 Compatible. OLC Technology (Remote Powering) <sup>(1)</sup>	1
238005	FiberKom Optical Mini-node 1550nm "SC/APC" Return Path 1610nm (1 Fiber) with Amplifier 105...1218MHz DOCSIS 3.0 Compatible. OLC Technology (Local Powering) <sup>(1)</sup>	1
238101	FiberKom Optical Mini-receiver 1200...1600nm "SC/APC" without Return Path (1 Fiber) with Amplifier 47...1006MHz, OLC Technology (Remote Powering) <sup>(1)</sup>	1
<b>OPTICAL MICRO-NODES</b>		
231111	Domestic Optical Receiver 1550nm "SC/APC" with Amplifier 47...1006MHz, OLC Technology <sup>(1)</sup>	1
231110	Domestic Optical Receiver 1200...1600nm "SC/APC" with Amplifier 47...1006MHz, OLC Technology <sup>(1)</sup>	1
2311	Domestic Optical Receiver 1200...1600nm "SC/APC" with Amplifier 87...862/950...2150MHz with Automatic Adjustment	1



▲ Outdoor Node:  
232 x 140 x 90 mm



▲ Mini-Node: FiberKom Series  
185 x 80 x 35 mm



▲ Micro-Node:  
145 x 60 x 35 mm

## Optical node: Configuration Scheme

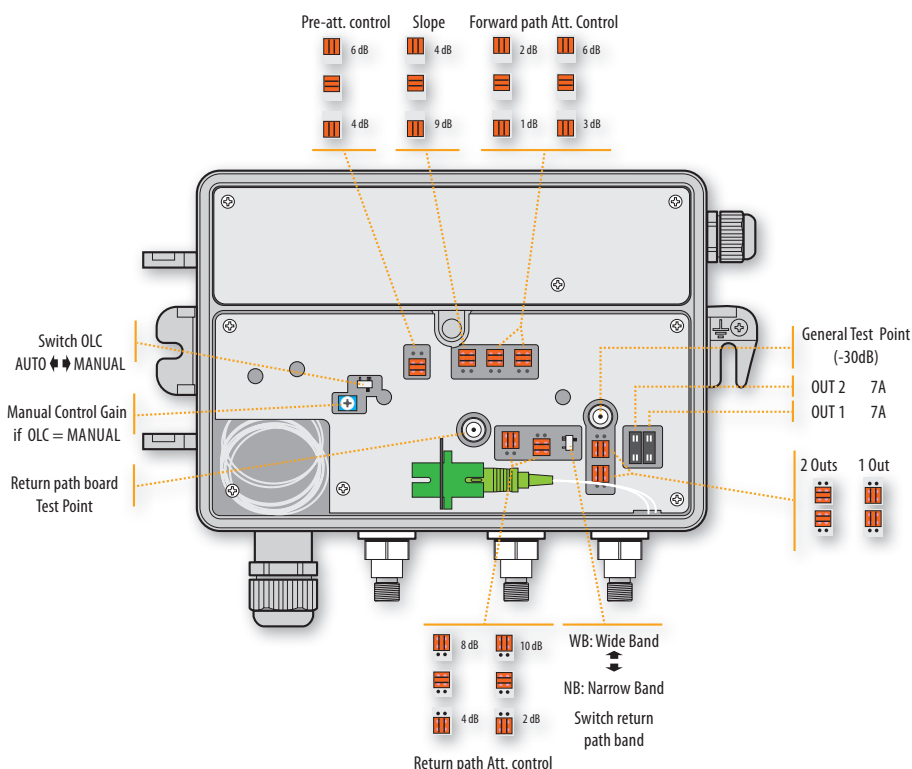

(1) OLC Technology: Optical Level Control.

Ref.	Description	
<b>F.O. DISTRIBUTION</b>		
<b>RACKS AND ACCESSORIES</b>		
533106	19" Rack Cabinet 6U. Glazed Door and Accesible from the side. Wall/Ground Mount	1
533108	19" Rack Cabinet 8U. Glazed Door and Accesible from the side. Wall/Ground Mount	1
533113	19" Rack Cabinet 13U. Glazed Door and Accesible from the side. Wall/Ground Mount	1
533117	19" Rack Cabinet 17U. Glazed Door and Accesible from the side. Wall/Ground Mount	1
533124	19" Rack Cabinet 24U. Glazed Door and Accesible from the side. Ground Mount	1
533150	Panel for Rack 19" 1RU, Up to 24 "F" connectors	1
533153	T.OX Panel for Rack 19" 1RU, Up to 2x7 "F" connectors	1
533151	Panel for Rack 19" 1RU, Up to 24 "RJ45" connectors	1
533154	Cable Management for Rack 19" 1RU, 5 Holes	1
533156	Cable Management for Rack 19" 1RU, 5 Rings	1
533152	Splice Box for Rack 19" 1RU, Up to 24 "SC" connectors (Depth 230mm)	1
533155	Tray for Rack 19" 2RU (Depth 265mm)	1
533161	Blank Panel for Rack 19" 1RU	1
533163	Blank Panel for Rack 19" 3RU	1
533165	Blank Panel for Rack 19" 5RU	1
533170	Screw Kit for Rack 19": Screw with washer and nut (50 units)	1
<b>ENCLOSURES</b>		
233002	Main Terminal Enclosure for F.O., Indoor (Up to 48 "SC/APC" connectors)	1
233003	Stackable Main Enclosure for F.O., Indoor (Up to 48 "SC/APC" connectors)	1
231302	Splitting Terminal Enclosure for F.O., Indoor (Up to 24 fibers)	1
231301	Splitting Terminal Enclosure for F.O., Indoor (Up to 16 fibers)	1
231310	Splitting Terminal Enclosure for F.O., Indoor (Up to 8 fibers)	1
546701	Data/Coaxial/Fibre Network Terminal Enclosure	1
<b>USER ACCESS POINT (UAP)</b>		
231502	F.O. Patch/Splitting Box 2 to 4 Outs <sup>(1)</sup>	1
231520	F.O. Patch Box 2 to 4 Outs: 2 Pre-terminated Fibers of 15m on one end <sup>(1) (2)</sup>	1
231521	F.O. Patch Box 2 to 4 Outs: 2 Pre-terminated Fibers of 25m on one end <sup>(1) (2)</sup>	1
231522	F.O. Patch Box 2 to 4 Outs: 2 Pre-terminated Fibers of 40m on one end <sup>(1) (2)</sup>	1
231523	F.O. Patch Box 2 to 4 Outs: 2 Pre-terminated Fibers of 55m on one end <sup>(1) (2)</sup>	1
231524	F.O. Patch Box 2 to 4 Outs: 2 Pre-terminated Fibers of 70m on one end <sup>(1) (2)</sup>	1
231525	F.O. Patch Box 2 to 4 Outs: 2 Pre-terminated Fibers of 85m on one end <sup>(1) (2)</sup>	1
231526	F.O. Patch Box 2 to 4 Outs: 2 Pre-terminated Fibers of 100m on one end <sup>(1) (2)</sup>	1
231530	F.O. Patch Box 4 Outs: 4 Pre-terminated Fibers of 15m on one end <sup>(1) (2)</sup>	1
231531	F.O. Patch Box 4 Outs: 4 Pre-terminated Fibers of 25m on one end <sup>(1) (2)</sup>	1
231532	F.O. Patch Box 4 Outs: 4 Pre-terminated Fibers of 40m on one end <sup>(1) (2)</sup>	1
231533	F.O. Patch Box 4 Outs: 4 Pre-terminated Fibers of 55m on one end <sup>(1) (2)</sup>	1
231534	F.O. Patch Box 4 Outs: 4 Pre-terminated Fibers of 70m on one end <sup>(1) (2)</sup>	1
231535	F.O. Patch Box 4 Outs: 4 Pre-terminated Fibers of 85m on one end <sup>(1) (2)</sup>	1
231536	F.O. Patch Box 4 Outs: 4 Pre-terminated Fibers of 100m on one end <sup>(1) (2)</sup>	1



▲ 533113  
600 x 690 x 400mm

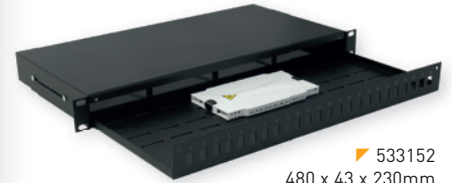

▲ 533152  
480 x 43 x 230mm

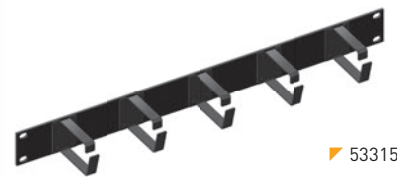

▲ 533156

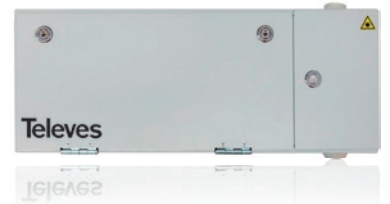

▲ 233003  
444 x 180 x 125 mm



▲ 233002  
454 x 358 x 95 mm

▲ 231302  
206 x 300 x 110 mm



▲ 231301  
153 x 264 x 67 mm



▲ 231310  
203 x 106 x 30 mm

Types of Rack Cabinets	
Ref.	Dimensions (mm)
533106	600 x 380 x 400
533108	600 x 460 x 400
533113	600 x 690 x 400
533117	600 x 870 x 400
533124	600 x 1200 x 600



▲ 23152x / 23153x

(1) "SC/APC" (Female - Female) Adapters and dispenser box included.

(2) ITU-T G657A2 single-mode fibers.

**FIBER OPTICS**

Ref.	Description		
<b>F.O. CABLES (ITU-T G657A2)</b>			
<b>MULTI-FIBER CABLES (FIBER'S TIGHT BUFFER Ø 250µm)</b>			
231612	Multi-fiber Cable 24 Single-mode Fibers LSFH	○	By m
231712	Multi-fiber Cable 48 Single-mode Fibers LSFH	○	By m
<b>MULTI-FIBER CABLES (FIBER'S TIGHT BUFFER Ø 900µm)</b>			
231802	Multi-fiber Cable 12 Single-mode Fibers LSFH	○	By m
231603	Multi-fiber Cable 24 Single-mode Fibers LSFH	○	By m
231702	Multi-fiber Cable 48 Single-mode Fibers LSFH	○	By m
<b>4 FIBER CABLES (FIBER'S TIGHT BUFFER Ø 250µm)</b>			
231911	4 Fibre Cable Single-mode Indoor LSFH	○	300
<b>2 FIBER CABLES (FIBER'S TIGHT BUFFER Ø 900µm)</b>			
231901	2 Fiber Cable Single-mode Indoor LSFH	○	300
231902	2 Fiber Cable Single-mode Indoor LSFH	○	750
232001	2 Fiber Cable Single-mode Outdoor LSFH	ⓑ	200
232002	2 Fiber Cable Single-mode Outdoor LSFH	ⓑ	500
<b>PRE-TERMINATED PATCH CORDS (Ø 3mm)</b>			
232622	F.O. Patch Cord Single-mode LSFH Pre-terminated "SC/APC" - "SC/PC" 0.2m		5
232621	F.O. Patch Cord Single-mode LSFH Pre-terminated "SC/APC" 2m (Bag B4)		10
232640	F.O. Duplex Patch Cord Single-mode LSFH Pre-terminated "SC/APC" 10m		1
232641	F.O. Duplex Patch Cord Single-mode LSFH Pre-terminated "SC/APC" 15m		1
232642	F.O. Duplex Patch Cord Single-mode LSFH Pre-terminated "SC/APC" 20m		1
232643	F.O. Duplex Patch Cord Single-mode LSFH Pre-terminated "SC/APC" 25m		1
232644	F.O. Duplex Patch Cord Single-mode LSFH Pre-terminated "SC/APC" 30m		1
232645	F.O. Duplex Patch Cord Single-mode LSFH Pre-terminated "SC/APC" 40m		1
<b>ACCESSORIES</b>			
2327	Splicing Protection Sleeve 60mm for Fiber Optics Fusion (for Fusion Splicer)		200
232701	Splicing Protection Sleeve 43mm for Fiber Optics Fusion (for Fusion Splicer)		200
2328	Mechanical Splices of Fiber Optics (for Mechanical Splicer)		10
2329	Connectors of Fiber Optics "SC/APC" (with mounting tool)		10
232602	F.O. Patch Cord Single-mode LSFH Pre-terminated "SC/APC" 2m (ITU-T G657A2, 900µm) Convertible to Pigtail		25
233203	Adapter "SC/APC" Female - "SC/APC" Female, with Auto-blocking Cap		25
212001	Coaxial Cable / Optical Fiber Dispenser, Small model (plastic drums) <sup>(1)</sup>		1
212011	Coaxial Cable / Optical Fiber Dispenser, Large model (plastic drums) <sup>(2)</sup>		1

\*By m\* = Cut to length.



▲ 232621:  
Patch cord



▲ 2120xx  
(Cable drum not included)



▲ 23264x:  
Duplex patch cord



▲ 2328



▲ 233203

**F.O. CABLES**

*Fibre's tight buffer Ø 250µm*



▲ 48 Fibres  
(231712)



▲ 24 Fibres  
(231612)



▲ 4 Fibres - Indoor  
(231911)



*Fibre's tight buffer Ø 900µm*



▲ 48 Fibres  
(231702)

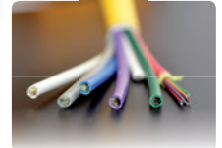

▲ 24 Fibres  
(231603)



▲ 12 Fibres  
(231802)



▲ 2 Fibres - Indoor  
(231901 / 231902)



▲ 2 Fibres - Outdoor  
(232001 / 232002)



▲ 232602

(1) For 2 fiber cable in 200 or 300m drum.

(2) For 2 fiber cable in 500 or 750m drum.

# FIBER OPTICS (OPTICAL LNB)

Ref.	Description		
<b>F.O. DISTRIBUTION (Optical LNB)</b>			
<b>OPTICAL LNBs</b>			
2353	Offset Optical LNB 1310nm "FC/PC" G 72dB Po 7dBm (Up to 32 converters), Grey		1
2363	P.F. Optical LNB 1310nm "FC/PC" G 72dB Po 7dBm Grey		1
<b>OPTICAL FIBER / RF CONVERTERS: SATELLITE + TERRESTRIAL</b>			
236801	RF/Optical Converter ODU32 1310nm "F"- "N"- "FC/PC": DAB/UHF-SAT + Offset LNB + AC/DC Adapter + Interconnection Accessories		1
236810	RF/Optical Converter ODU32 1550nm "F"- "N"- "FC/PC": DAB/UHF-SAT + Offset LNB + AC/DC Adapter + Interconnection Accessories		1
236903	Optical/RF Converter "FC/PC"- "F" Quad FM/DAB/UHF-SAT		1
237003	Optical/RF Converter "FC/PC"- "F" Quattro FM/DAB/UHF-SAT		1
<b>FTTH TRANSMISSION &amp; RECEPTION</b>			
237301	Optical Transmitter / Multiplexer "SC/APC". 2i: 1310/1490nm(Sat) - RF(Terr.), 1o: 1310/1490/1550nm(Sat/Terr.)		1
237311	Optical Receiver / Demultiplexer "SC/APC". 1i: 1310/1490/1550nm(Sat/Terr.), 2o: 1310/1490nm(Sat) - RF(Terr.)		1
<b>SPLITTERS</b>			
235701	Optical Splitter 1310/1550nm "FC/PC" 2W 4dB		1
235801	Optical Splitter 1310/1550nm "FC/PC" 3W 5.5dB		1
235901	Optical Splitter 1310/1550nm "FC/PC" 4W 7dB		1
236001	Optical Splitter 1310/1550nm "FC/PC" 8W 10.1dB		1
<b>ATTENUATORS</b>			
2364	Optical Attenuator 1310/1550nm "FC/PC" 5dB		1
2365	Optical Attenuator 1310/1550nm "FC/PC" 10dB		1
2366	Optical Attenuator 1310/1550nm "FC/PC" 15dB		1
<b>PRE-TERMINATED PATCH CORDS</b>			
236110	F.O. Patch Cord Single-mode LSFH Pre-terminated "FC/PC" 1m		1
2361	F.O. Patch Cord Single-mode LSFH Pre-terminated "FC/PC" 3m		1
236101	F.O. Patch Cord Single-mode LSFH Pre-terminated "FC/PC" 5m		1
236102	F.O. Patch Cord Single-mode LSFH Pre-terminated "FC/PC" 10m		1
236103	F.O. Patch Cord Single-mode LSFH Pre-terminated "FC/PC" 20m		1
236104	F.O. Patch Cord Single-mode LSFH Pre-terminated "FC/PC" 30m		1
236105	F.O. Patch Cord Single-mode LSFH Pre-terminated "FC/PC" 40m		1
236106	F.O. Patch Cord Single-mode LSFH Pre-terminated "FC/PC" 50m		1
236107	F.O. Patch Cord Single-mode LSFH Pre-terminated "FC/PC" 75m		1
236108	F.O. Patch Cord Single-mode LSFH Pre-terminated "FC/PC" 100m		1
236109	F.O. Patch Cord Single-mode LSFH Pre-terminated "FC/PC" 200m		1
<b>ACCESSORIES</b>			
237050	Power Supply Unit 20V-1.2A (for Ref. 237003)		1
2354	Fiber Optics Connector for 2 "FC"- "FC" Pre-terminated Patch Cords Interconnection		5
2356	Fiber Optics Adapter for a "FC"- "SC" Connector Change, of 2 Pre-terminated Patch Cords		5



▲ 2361xx



▲ 2354



▲ 2356



▲ 235701

## FULL SAT + DTT (FTTH)



▲ Transmitter (237301)



▲ Receiver (237311)

Optical system with WDM (Full SAT + DTT) allows the distribution of the whole contents of a satellite and the whole terrestrial band on a single fibre.



▲ 236810



▲ 236903



▲ 237003

Ref.	Description	
<b>NEVOSWITCH SERIES: STAND ALONE &amp; CASCADE MULTISWITCHES</b>		
<b>5 INPUTS (1 SATELLITE + TERRESTRIAL)</b>		
714501	Multiswitch 5x5x4 "F" Terminal/Cascade	1
714502	Multiswitch 5x5x6 "F" Terminal/Cascade	1
714503	Multiswitch 5x5x8 "F" Terminal/Cascade	1
714504	Multiswitch 5x5x12 "F" Terminal/Cascade	1
714505	Multiswitch 5x5x16 "F" Terminal/Cascade	1
714506	Multiswitch 5x5x24 "F" Terminal/Cascade	1
714507	Multiswitch 5x5x32 "F" Terminal/Cascade	1
714508	Amplifier 5x5 "F" MATV/IF G 12/15dB Vo 110dBμV	1
714509	Amplifier 5x5 "F" MATV/IF G 27/25dB Vo 110dBμV	1
714906	Tap 5x5x5 "F" 8dB	1
714901	Tap 5x5x5 "F" 12dB	1
714902	Tap 5x5x5 "F" 15dB	1
714903	Tap 5x5x5 "F" 20dB	1
714904	Tap 5x5x5 "F" 25dB	1
714905	Splitter 5x5x5 4/4dB	1
<b>5 INPUTS (1 SATELLITE + TERRESTRIAL) - QUAD COMPATIBLE</b>		
714402	Quad Compatible Multiswitch 5x5x6 "F" Terminal/Cascade (12V-0.8A PSU included)	1
714403	Quad Compatible Multiswitch 5x5x8 "F" Terminal/Cascade (12V-0.8A PSU included)	1
714404	Quad Compatible Multiswitch 5x5x12 "F" Terminal/Cascade (12V-0.8A PSU included)	1
714405	Quad Compatible Multiswitch 5x5x16 "F" Terminal/Cascade (12V-0.8A PSU included)	1
<b>5 INPUTS (1 SATELLITE + PASSIVE TERRESTRIAL)</b>		
714303	Multiswitch 5x5x8 "F" Terminal/Cascade, Passive Terrestrial	1
714304	Multiswitch 5x5x12 "F" Terminal/Cascade, Passive Terrestrial	1
714305	Multiswitch 5x5x16 "F" Terminal/Cascade, Passive Terrestrial	1
<b>5 INPUTS (1 SATELLITE + TERRESTRIAL) - dCSS TECHNOLOGY , MULTICHOICE COMPATIBLE </b>		
714121	dCSS Multiswitch 5x5x2 "F" Terminal/Cascade, Switchable Adjustable/Passive Terrestrial	1
714122	dCSS Multiswitch 5x5x4 "F" Terminal/Cascade, Switchable Adjustable/Passive Terrestrial	1
<b>9 INPUTS (2 SATELLITES + TERRESTRIAL)</b>		
714601	Multiswitch 9x9x8 "F" Terminal/Cascade	1
714602	Multiswitch 9x9x12 "F" Terminal/Cascade	1
714603	Multiswitch 9x9x16 "F" Terminal/Cascade	1
714604	Multiswitch 9x9x24 "F" Terminal/Cascade	1
714605	Multiswitch 9x9x32 "F" Terminal/Cascade	1
714609	Amplifier 9x9 "F" Ret.P/MATV/IF G -27/25dB Vo 110dBμV	1
<b>9 INPUTS (2 SATELLITES + TERRESTRIAL) - QUAD COMPATIBLE</b>		
714241	Quad Compatible Multiswitch 9x9x8 "F" Terminal/Cascade	1
714242	Quad Compatible Multiswitch 9x9x12 "F" Terminal/Cascade	1
714243	Quad Compatible Multiswitch 9x9x16 "F" Terminal/Cascade	1
714244	Quad Compatible Multiswitch 9x9x24 "F" Terminal/Cascade	1
714245	Quad Compatible Multiswitch 9x9x32 "F" Terminal/Cascade	1

## NEVOSWITCH SERIES

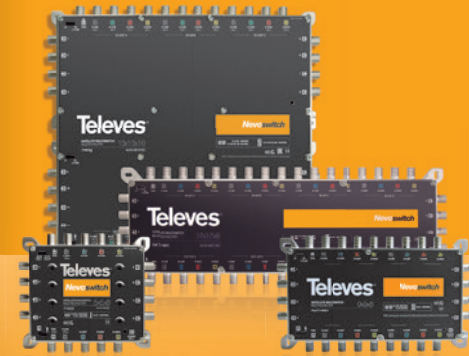

Scalable multiswitches range, european design, manufacturing and quality.



SCAN TO WATCH THE VIDEO  
EN.TELEVES.COM/NEVOSWITCH

THE NEW AND INNOVATIVE NEVOSWITCH IMPLEMENTING dCSS TECHNOLOGY, WITH DCFLEX FUNCTIONALITY



DCFLEX gives complete flexibility when choosing how to power the dCSS NevoSwitch to suit any installation scenario. This versatility is achieved by a toggle switch that can isolate the multiswitch from the cascade's DC power configuration.



▲ 714241

Ref.	Description	
------	-------------	--

## NEVOSWITCH SERIES: STAND ALONE & CASCADE MULTISWITCHES

### 13 INPUTS (3 SATELLITES + TERRESTRIAL)

714701	Multiswitch 13x13x8 "F" Terminal/Cascade	1
714702	Multiswitch 13x13x12 "F" Terminal/Cascade	1
714703	Multiswitch 13x13x16 "F" Terminal/Cascade	1
714704	Multiswitch 13x13x24 "F" Terminal/Cascade	1
714705	Multiswitch 13x13x32 "F" Terminal/Cascade	1
714709	Amplifier 13x13 "F" Ret.P/MATV/IF G -/27/25dB Vo 110dBµV	1

### 17 INPUTS (4 SATELLITES + TERRESTRIAL)

714801	Multiswitch 17x17x8 "F" Terminal/Cascade	1
714802	Multiswitch 17x17x12 "F" Terminal/Cascade	1
714803	Multiswitch 17x17x16 "F" Terminal/Cascade	1
714804	Multiswitch 17x17x24 "F" Terminal/Cascade	1
714805	Multiswitch 17x17x32 "F" Terminal/Cascade	1
714809	Amplifier 17x17 "F" Ret.P/MATV/IF G -/27/25dB Vo 110dBµV	1

### POWER SUPPLY UNITS

732101	Power Supply Unit 12V-0.8A	1
732210	Power Supply Unit 12V-1.5A (UK plug)	1
732802	Power Supply Unit 12.5V-2.8A	1
732001	Power Supply Unit 18V-2A (NevoSwitch dCSS)	1

### ACCESSORIES

993810	Earth Bonding Bar 4 Connectors (9x/13x/17x NevoSwitch compatible)	1
993811	Earth Bonding Bar 5 Connectors (5x/9x/13x/17x NevoSwitch compatible)	1
3821	Adapter "Quick F" Male - "F" Male, Plastic Box	50/500

## EASYSWITCH SERIES

719001	Multiswitch 5x5x4 "EasyF" Terminal/Cascade (Adjustable Attenuator)	1
719101	Amplifier 5x5 "EasyF" MATV/SAT G 14/28dB Vo 111/110dBµV w/AGC	1

## CABINETS

5894	Perforated Mounting Plate 300x400mm, Distance from the wall 19mm	1
589401	Perforated Mounting Plate 400x400mm, Distance from the wall 19mm	1
589402	Perforated Mounting Plate 400x600mm, Distance from the wall 19mm	1
5893	Indoor Lockable Cabinet with Mounting Plate, Dimensions: 300x400x200mm	1
589301	Indoor Lockable Cabinet with Mounting Plate, Dimensions: 400x400x200mm	1
589302	Indoor Lockable Cabinet with Mounting Plate, Dimensions: 400x600x200mm	1
589303	Indoor Lockable Cabinet with Mounting Plate, Dimensions: 600x600x200mm	1
589304	Indoor Lockable Cabinet with Mounting Plate, Dimensions: 600x800x200mm	1
5749	Outdoor Lockable Cabinet (IP66 Standard), Dimensions: 600x380x210mm	1



▲ 714801



▼ 732001



▲ 993810

▲ 993811



▼ 719001



▲ 5749



▼ 3821



▲ 5893

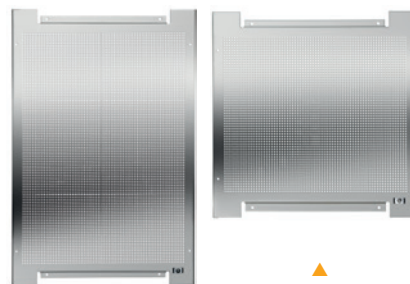

▲ 589401

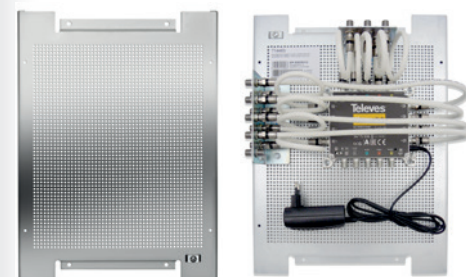

▲ 5894

▲ Mounting with ref. 5894

Ref.	Description		
<b>SPLITTERS WITH "EasyF" CONNECTOR</b>			
<b>5...2400MHz</b>			
543503	Mini-Splitter 5...2400MHz "EasyF" 2W 4.3/4dB Indoor DC Pass O-I		10
543603	Mini-Splitter 5...2400MHz "EasyF" 3W 8.5/7.5dB Indoor DC Pass O-I		10
543702	Splitter 5...2400MHz "EasyF" 4W 9/7.5dB Indoor DC Pass O-I		10
543802	Splitter 5...2400MHz "EasyF" 5W 10/9.5dB Indoor DC Pass O-I		10
5469	Splitter 5...2400MHz "EasyF" 6W 11/14dB Indoor DC Pass O-I		10
5489	Splitter 5...2400MHz "EasyF" 8W 14/16dB Indoor DC Pass O-I		10
434103	Mini-Splitter 5...2400MHz "EasyF" 2W 4.3/4dB DC Pass O-I With Outdoor Mounting Case (Blister T1)	B	10
434202	Splitter 5...2400MHz "EasyF" 4W 9/7dB DC Pass O-I With Outdoor Mounting Case (Blister T1)	B	8
<b>ACCESSORIES</b>			
545510	Face Plate for Mini Series White 62x56x18mm	W	10
417801	Outdoor Case Black Model for Mini Series Dimensions: External 88x78x39mm Internal 57x47x13mm	B	1/10
545501	Face Plate White 93x74x21mm	W	10
4177	Outdoor Case Black Small Model Dimensions: External 113x88x35mm Internal 92x66x27mm	B	1/5
4163	Outdoor Case Grey Large Model Dimensions: External 136x127x45mm Internal 125x97x35mm	G	1/5
4087	Terminal Load "EasyF" 750hm with DC Blocked		25
408701	Terminal Load "EasyF" 750hm with DC Blocked, Plastic Box		100
<b>SPLITTERS WITH "F" CONNECTOR</b>			
<b>5...2400MHz</b>			
5150	Splitter 5...2400MHz "F" 2W 4/5dB Indoor		1/10
5151	Splitter 5...2400MHz "F" 3W 7/9dB Indoor		1/10
5152	Splitter 5...2400MHz "F" 4W 7.5/10dB Indoor		1/10
5153	Splitter 5...2400MHz "F" 5W 10/12dB Indoor		1/10
7441	Splitter 5...2400MHz "F" 6W 12/16dB Indoor		1/10
7406	Splitter 5...2400MHz "F" 8W 13/18dB Indoor		1/10
5155	Splitter 5...2400MHz "F" 2W 4/5dB Indoor DC Pass All		1/10
5156	Splitter 5...2400MHz "F" 4W 7.5/10dB Indoor DC Pass All		1/10
5157	Splitter 5...2400MHz "F" 5W 10/12dB Indoor DC Pass All		1/10
5158	Splitter 5...2400MHz "F" 6W 10/12dB Indoor DC Pass All		1/10
5159	Splitter 5...2400MHz "F" 8W 11/14dB Indoor DC Pass All		1/10
7402	Splitter 950...2150MHz "F" 8W 1...4dB Indoor Active		1
<b>5...1000MHz</b>			
4530	Splitter 5...1000MHz "F" 2W 4dB Indoor		1/10
453002	Splitter 5...1000MHz "F" 2W 4dB Indoor		100
4532	Splitter 5...1000MHz "F" 3W 6dB Indoor		1/10
4531	Splitter 5...1000MHz "F" 4W 8dB Indoor		1/10
4534	Splitter 5...1000MHz "F" 6W 10dB Indoor		1/10
4533	Splitter 5...1000MHz "F" 8W 11dB Indoor		1/10
<b>ACCESSORIES</b>			
545501	Face Plate White 93x74x21mm	W	10
4177	Outdoor Case Black Small Model Dimensions: External 113x88x35mm Internal 92x66x27mm	B	1/5
4163	Outdoor Case Grey Large Model Dimensions: External 136x127x45mm Internal 125x97x35mm	G	1/5
4061	Terminal Load "F" 750hm with DC Blocked		10/200
4058	Terminal Load "F" 750hm without DC Blocked		10/200
405802	Terminal Load "F" 750hm without DC Blocked, Plastic Box		100
<b>SPLITTERS WITH 5/8" CONNECTOR (OUTDOOR)</b>			
<b>5...1000MHz</b>			
4622	Splitter 5...1000MHz 5/8" 2W 6dB Outdoor		1
4623	Splitter 5...1000MHz 5/8" 3W 10dB Outdoor		1



▲ Mini-Splitter  
57x 47 x 13 mm

BLACK OUTDOOR CASE FOR MINI SERIES



▲ 417801

WHITE FACE PLATE FOR MINI SERIES



▲ 545510



▲ 543802



▲ 5150



▲ 5153



▲ 4623

Ref.	Description		
------	-------------	--	--

**TAPS WITH "EasyF" CONNECTOR**

**5...2400MHz**

542503	Mini-Tap 5...2400MHz "EasyF" 2W 12dB Indoor DC Pass I-O (TA - Floor 1)	10	
542603	Mini-Tap 5...2400MHz "EasyF" 2W 16dB Indoor DC Pass I-O (A - Floors 2 & 3)	10	
542703	Mini-Tap 5...2400MHz "EasyF" 2W 21dB Indoor DC Pass I-O (B - Floors 4...6)	10	
542803	Mini-Tap 5...2400MHz "EasyF" 2W 25dB Indoor DC Pass I-O (C - Floors 7...12)	10	
544402	Tap 5...2400MHz "EasyF" 4W 12dB Indoor DC Pass I-O (TA - Floor 1)	10	
544502	Tap 5...2400MHz "EasyF" 4W 16dB Indoor DC Pass I-O (A - Floors 2 & 3)	10	
544602	Tap 5...2400MHz "EasyF" 4W 20dB Indoor DC Pass I-O (B - Floors 4 & 5)	10	
544702	Tap 5...2400MHz "EasyF" 4W 25dB Indoor DC Pass I-O (C - Floors 6...8)	10	
5492	Tap 5...2400MHz "EasyF" 6W 16dB Indoor DC Pass I-O (TA - Floor 1)	6	
5493	Tap 5...2400MHz "EasyF" 6W 20dB Indoor DC Pass I-O (A - Floors 2 & 3)	6	
5494	Tap 5...2400MHz "EasyF" 6W 24dB Indoor DC Pass I-O (B - Floors 4 & 5)	6	
5610	Tap 5...2400MHz "EasyF" 8W 16dB Indoor DC Pass I-O (TA - Floor 1)	6	
5611	Tap 5...2400MHz "EasyF" 8W 22dB Indoor DC Pass I-O (A - Floor 2)	6	

**ACCESSORIES**

545510	Face Plate for Mini Series White 62x56x18mm	Ⓜ	10
417801	Outdoor Case Black Model for Mini Series Dimensions: External 88x78x39mm Internal 57x47x13mm	Ⓑ	1/10
545501	Face Plate White 93x74x21mm	Ⓜ	10
4177	Outdoor Case Black Small Model Dimensions: External 113x88x35mm Internal 92x66x27mm	Ⓑ	1/5
4163	Outdoor Case Grey Large Model Dimensions: External 136x127x45mm Internal 125x97x35mm	Ⓒ	1/5
4087	Terminal Load "EasyF" 750hm with DC Blocked		25
408701	Terminal Load "EasyF" 750hm with DC Blocked, Plastic Box		100

**TAPS WITH "F" CONNECTOR**

**5...2400MHz**

5130	Tap 5...2400MHz "F" 2W 12dB Indoor (TA - Floor 1)	1/10	
5131	Tap 5...2400MHz "F" 2W 15dB Indoor (A - Floors 2 & 3)	1/10	
5132	Tap 5...2400MHz "F" 2W 18dB Indoor (B - Floors 4 & 5)	1/10	
5133	Tap 5...2400MHz "F" 2W 23dB Indoor (C - Floors 6 & 7)	1/10	
5134	Tap 5...2400MHz "F" 2W 27dB Indoor (D - Floors 8...10)	1/10	
514110	Tap 5...2400MHz "F" 4W 12dB Indoor DC Pass All (TA - Floor 1)	1/10	
514210	Tap 5...2400MHz "F" 4W 16dB Indoor DC Pass All (A - Floors 2 & 3)	1/10	
514310	Tap 5...2400MHz "F" 4W 19dB Indoor DC Pass All (B - Floors 4 & 5)	1/10	
514410	Tap 5...2400MHz "F" 4W 24dB Indoor DC Pass All (C - Floors 6...8)	1/10	
5145	Tap 5...2400MHz "F" 4W 29dB Indoor (D - Floors 9 & 10)	1/10	
5135	Tap 5...2400MHz "F" 6W 19dB Indoor (TA - Floor 1)	1/10	
5136	Tap 5...2400MHz "F" 6W 21dB Indoor (A - Floors 2 & 3)	1/10	
5137	Tap 5...2400MHz "F" 6W 25dB Indoor (B - Floors 4...6)	1/10	
5146	Tap 5...2400MHz "F" 8W 19dB Indoor (TA - Floor 1)	1/10	
5147	Tap 5...2400MHz "F" 8W 20dB Indoor (A - Floors 2 & 3)	1/10	
5148	Tap 5...2400MHz "F" 8W 25dB Indoor (B - Floors 4...6)	1/10	

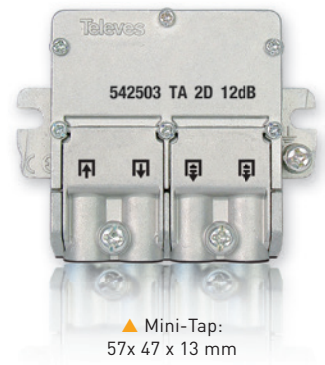



# DISTRIBUTION

Ref.	Description		
------	-------------	--	--

## TAPS WITH "F" CONNECTOR

### 5...1000MHz

4518	Tap 5...1000MHz "F" 1W 14dB Indoor	1/10
4519	Tap 5...1000MHz "F" 1W 17dB Indoor	1/10
4560	Tap 5...1000MHz "F" 2W 4dB Indoor	1/10
4561	Tap 5...1000MHz "F" 2W 8dB Indoor	1/10
4562	Tap 5...1000MHz "F" 2W 11dB Indoor	1/10
4563	Tap 5...1000MHz "F" 2W 14dB Indoor	1/10
4565	Tap 5...1000MHz "F" 2W 20dB Indoor	1/10
4566	Tap 5...1000MHz "F" 2W 23dB Indoor	1/10
4567	Tap 5...1000MHz "F" 2W 26dB Indoor	1/10
4571	Tap 5...1000MHz "F" 4W 8dB Indoor	1/10
4572	Tap 5...1000MHz "F" 4W 11dB Indoor	1/10
4573	Tap 5...1000MHz "F" 4W 14dB Indoor	1/10
4574	Tap 5...1000MHz "F" 4W 17dB Indoor	1/10
4575	Tap 5...1000MHz "F" 4W 20dB Indoor	1/10
4576	Tap 5...1000MHz "F" 4W 23dB Indoor	1/10
4577	Tap 5...1000MHz "F" 4W 26dB Indoor	1/10
4578	Tap 5...1000MHz "F" 8W 12dB Indoor	1/10
4580	Tap 5...1000MHz "F" 8W 17dB Indoor	1/10
4581	Tap 5...1000MHz "F" 8W 20dB Indoor	1/10

### ACCESSORIES

545501	Face Plate White 93x74x21mm	Ⓜ	10
4177	Outdoor Case Black Small Model Dimensions: External 113x88x35mm Internal 92x66x27mm	ⓑ	1/5
4163	Outdoor Case Grey Large Model Dimensions: External 136x127x45mm Internal 125x97x35mm	Ⓒ	1/5
4061	Terminal Load "F" 75Ohm with DC Blocked		10/200
4058	Terminal Load "F" 75Ohm without DC Blocked		10/200
405802	Terminal Load "F" 75Ohm without DC Blocked, Plastic Box		100

## TAPS WITH "F" TAP PORTS & 5/8" IN/OUT PORTS CONNECTORS (OUTDOOR)

### 5...1000MHz

4611	Tap 5...1000MHz "F" Tap Ports & 5/8" In/Out Ports 2W 35dB Outdoor	1
------	---	---



▲ 4518

▲ 4560



▲ 4571



▲ 4578



▲ 545501



▲ 4177

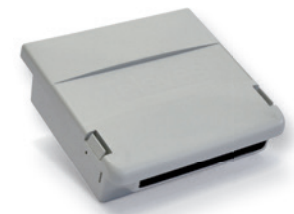

▲ 4163



▲ 4611

Ref.	Description		
<b>OUTLETS</b>			
<b>END OUTLETS</b>			
5232	End Outlet Diplexed 5...1000MHz, TV-FM 0.5-3dB without DC Pass		10/100
5226	End Outlet Diplexed 5...862/950...2150MHz, TV/FM-SAT 0.6-1.5dB with DC Pass		10/100
522610	End Outlet Diplexed 5...790/950...2150MHz, TV/FM-SAT 0.6-1.5dB with DC Pass	<b>LTE790</b>	10/100
5276	End Outlet Diplexed 5...862/950...2150MHz, TV/FM-SAT 0.6-1.5dB with DC Pass (without Clamps)		10/100
527610	End Outlet Diplexed 5...790/950...2150MHz, TV/FM-SAT 0.6-1.5dB with DC Pass (without Clamps)	<b>LTE790</b>	10/100
524603	End Outlet Triplexed 5...2400MHz, TV-FM-SAT 4-4-1.5dB with DC Pass		10/100
524501	End Outlet Triplexed 5...2400MHz, TV/FM-SAT1-SAT2 1-1.5-1dB with DC Pass		10/100
5250	End Outlet Triplexed 5...2150MHz, TV-FM-SAT/DATA 5-3.8-6.5/4.5dB with DC Pass		10/100
5270	Through Outlet Bridged (Chassis Only)		10/100
<b>5...790/862MHz - LOW THROUGH LOSSES</b>			
5230	End Outlet 5...862MHz, TV-FM 4.5-18dB without DC Pass		10/100
5231	Through Outlet 5...862MHz, TV-FM 9.5-24dB without DC Pass		10/100
523110	Through Outlet 5...790MHz, TV-FM 9.5-24dB without DC Pass	<b>LTE790</b>	10/100
<b>5...1000MHz</b>			
5232	End Outlet Diplexed 5...1000MHz, TV-FM 0.5-3dB without DC Pass		10/100
5233	Through Outlet 5...1000MHz, TV-FM 7-26dB without DC Pass		10/100
<b>5...2150MHz</b>			
5229	End Outlet Splitter 5...2150MHz,TV/FM-SAT 4-5dB with DC Pass (Floor 1)		10/100
5228	Through Outlet Diplexed 5...2150MHz,TV/FM-SAT 8.5-10dB with DC Pass (Floors 2)		10/100
5227	Through Outlet Splitter 5...2150MHz,TV/FM-SAT 13-14dB with DC Pass (Floors 3...5)		10/100
5236	Through Outlet Splitter 5...2150MHz,TV/FM-SAT 20-24dB with DC Pass (Floors 6...12)		10/100
<b>MULTIMEDIA</b>			
524001	End Outlet Multimedia 5...1006MHz, TV-FM-DATA 8-7-3.6dB		10/100
524701	Through Outlet Multimedia 5...1006MHz, TV-FM-DATA 12-14.5-12dB		10/100
524801	Through Outlet Multimedia 5...1006MHz, TV-FM-DATA 19-20-17.5dB		10/100
5249	Through Outlet Multimedia 5...1006MHz, TV-FM-DATA 23.5-23-22dB		10/100
<b>ACCESSORIES</b>			
<b>80x80mm</b>			
5441	Face Plate White for TV-R Outlet	Ⓜ	10
5440	Face Plate White for TV/R-SAT Outlet	Ⓜ	10
544302	Face Plate White for TV-R-SAT Outlet	Ⓜ	10
5275	Face Plate White for TV-R-SAT-DATA Outlet	Ⓜ	10
527402	Face Plate White for TV/R-SAT-DATA Outlet	Ⓜ	10
5442	Back Box White for Surface Mounting Outlet	Ⓜ	10
<b>85x85mm</b>			
544002	Face Plate White for TV/R-SAT Outlet	Ⓜ	10
544301	Face Plate White for TV-R-SAT Outlet	Ⓜ	10

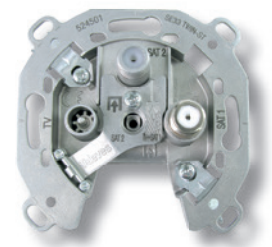

▲ 524501



▲ 522610



▲ 524603



▲ 5250 + 5275



▲ 544302



▲ 5442

Outlets: General technical specifications

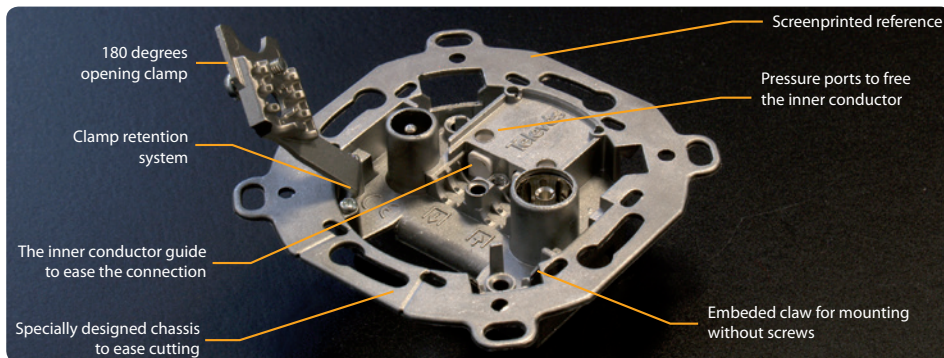

- A simple push is enough to connect the inner conductor, no screws needed.
- Support an inner conductor with diameters ranging from Ø 0,65 to Ø 1,2 mm.
- Support an outdoor cable with a diameter ranging from Ø 5 to Ø 6.9 mm.
- Allows the visualization of the connection.
- Compliant with the European guidelines 2014/30/EU, 2014/35/EU and RoHS 2011/65/EU.
- The outlets with data connection are compatible with DOCSIS 3.0.

# DISTRIBUTION

Ref.	Description	
<b>CONNECTORS</b>		
<b>"IEC" - Ø 9.5mm</b>		
4130	"IEC" Ø 9.5mm Connector Male Elbowed Shielded	25/250
4131	"IEC" Ø 9.5mm Connector Female Elbowed Shielded	25/250
413210	"PRO EasyF" "IEC" Ø 9.5mm Connector Male Elbowed Class A+ Shielded	25/250
413310	"PRO EasyF" "IEC" Ø 9.5mm Connector Female Elbowed Class A+ Shielded	25/250
<b>"F"</b>		
413410	"PRO EasyF" "Quick F" Connector Elbowed Class A+ Shielded	25/250
4176	"Quick F" Connector Elbowed Shielded	25/250
3802	"F" Connector Compression for TSH Triple Shielded Cables (SK), Plastic Box	50/500
410701	"Quick F" Connector Compression Elbowed for T-100 & CXT-60 Cables	50/500
4104	"F" Connector Compression for T-100 & CXT-60 Cables	100/1000
4105	"F" Connector Compression for CXT-5 (Ø 5mm) & CXT-50 Cables	100/1000
4106	"F" Connector Compression for TR-165 Cable	50/500
417102	"F" Connector Threaded with O-ring for T-100 Cable, Plastic Box	50
417101	"F" Connector Threaded with O-ring for T-100 Cable, Plastic Box	100/1000
4127	"F" Connector Threaded with O-ring for CXT-5 (Ø 5mm) Cable	30/720
3808	"F" Connector Threaded with O-ring for CXT-5 (Ø 5mm) Cable, Plastic Box	100/1000
9349	"F" Connector Threaded for TR-165 Cable	10/100
4120	"F" Connector for 1/2" Cable	1/20
<b>SCATV 5/8"</b>		
4122	5/8" Connector with O-ring for TR-165 Ø 11mm Cable	1
<b>ACCESSORIES</b>		
405701	Twin Adaptor "EasyF" Male - "F" Female	10
4066	Joint Connector for Coaxial Cable	25
3821	Adapter "Quick F" Male - "F" Male, Plastic Box	50/500
4173	Adapter "F" Female - "F" Female	10/200
4123	Adapter 5/8" Male - "F" Female	1/20
4071	DC Blocker "F"	10
4061	Terminal Load "F" 750hm with DC Blocked	10/200
4058	Terminal Load "F" 750hm without DC Blocked	10/200
405802	Terminal Load "F" 750hm without DC Blocked, Plastic Box	100
4087	Terminal Load "EasyF" 750hm with DC Blocked	25
408701	Terminal Load "EasyF" 750hm with DC Blocked, Plastic Box	100
<b>TOOLS</b>		
216101	Hex-11 Wrench for "F" Connectors	1/250
2163	Tool for "F" Compression Connectors	1
216310	Insertion Tool for "F" Compression Connectors	1



▲ 4130                      ▲ 4131



▲ 4176                      ▲ 3802



▲ 4104                      ▲ 4105



▲ 417101 / 417102                      ▲ 3808



▲ 9349                      ▲ 3821



▲ 4071                      ▲ 405802



▲ 4173                      ▲ 4061



▲ Plastic box



▲ 2163



▲ 216310

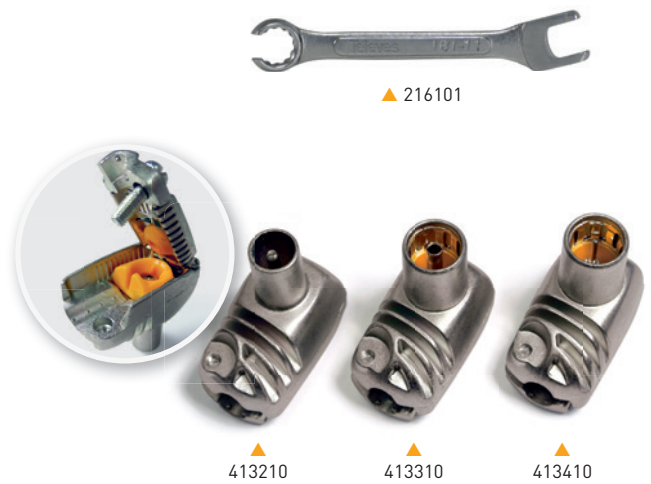

## PRO EASYF CLASS A+ CONNECTORS

THE EXCEPTIONAL SCREENING FOR A COAXIAL NETWORK

Ref.	Description		
<b>COAXIAL CABLES</b>			
<b>CU INNER CONDUCTOR / CuSn BRAID (CLASS A++ TRIPLE SHIELDED)</b>			
<b>EN 50117-2-4 / B2ca</b>			
413910	Coaxial Cable SK2020plus LSFH UV Resistant B2ca Class A++ Triple Shielded TSH 18AtC Ø 1.05/4.6/6.9mm White		100
413911	Coaxial Cable SK2020plus LSFH UV Resistant B2ca Class A++ Triple Shielded TSH 18AtC Ø 1.05/4.6/6.9mm White		250
413912	Coaxial Cable SK2020plus LSFH UV Resistant B2ca Class A++ Triple Shielded TSH 18AtC Ø 1.05/4.6/6.9mm White		500
<b>CU INNER CONDUCTOR / CuSn BRAID (CLASS A+ TRIPLE SHIELDED) (1)</b>			
<b>EN 50117-2-5 / Dca</b>			
414002	Coaxial Cable SK2003plus LSFH UV Resistant Dca Class A+ Triple Shielded TSH 18AtC Ø 1.02/4.6/6.70mm Black		100
414003	Coaxial Cable SK2003plus LSFH UV Resistant Dca Class A+ Triple Shielded TSH 18AtC Ø 1.02/4.6/6.70mm Black		250
414004	Coaxial Cable SK2003plus LSFH UV Resistant Dca Class A+ Triple Shielded TSH 18AtC Ø 1.02/4.6/6.70mm Black		500
<b>EN 50117-2-4 / Eca</b>			
4138	Coaxial Cable SK2000plus PVC Eca Class A+ Triple Shielded TSH 18VAAtC Ø 1.02/4.6/6.70mm White		100
413802	Coaxial Cable SK2000plus PVC Eca Class A+ Triple Shielded TSH 18VAAtC Ø 1.02/4.6/6.70mm White		250
413801	Coaxial Cable SK2000plus PVC Eca Class A+ Triple Shielded TSH 18VAAtC Ø 1.02/4.6/6.70mm White		500
413705	Coaxial Cable SK110plus PVC Eca Class A+ Triple Shielded TSH 18VAAtC Ø 1.02/4.6/6.70mm White		100
413704	Coaxial Cable SK110plus PVC Eca Class A+ Triple Shielded TSH 18VAAtC Ø 1.02/4.6/6.70mm White		250
413706	Coaxial Cable SK110plus PVC Eca Class A+ Triple Shielded TSH 18VAAtC Ø 1.02/4.6/6.70mm White		500
413707	Coaxial Cable SK110plus PVC Eca Class A+ Triple Shielded TSH 18VAAtC Ø 1.02/4.6/6.70mm Black		250
<b>CU INNER CONDUCTOR / CU BRAID / BCT-C-H (CLASS A)</b>			
<b>EN 50117-2-4 / Eca</b>			
214102	Coaxial Cable T-100plus PVC Eca Class A 16VRtC Ø 1.13/4.8/6.6mm White		100
214104	Coaxial Cable T-100plus PVC Eca Class A 16VRtC Ø 1.13/4.8/6.6mm White		250
214108	Coaxial Cable T-100plus PVC Eca Class A 16VRtC Ø 1.13/4.8/6.6mm Black		100
<b>EN 50117-2-4 / Dca</b>			
215101	Coaxial Cable T-10plus LSFH Dca Class A 16VRtC Ø 1.12/4.7/6.6mm Grey		100
<b>EN 50117-2-5 / Fca</b>			
215501	Coaxial Cable T-100plus PE Fca Class A 16PRtC Ø 1.13/4.8/6.6mm Black		100
215502	Coaxial Cable T-100plus PE Fca Class A 16PRtC Ø 1.13/4.8/6.6mm Black		250
<b>CU INNER CONDUCTOR / CU+AL BRAID</b>			
<b>EN 50117-2-4 / Eca</b>			
2138	Coaxial Cable CXT PVC Cu/Cu+Al 18VRtC Ø 1.00/4.8/6.6mm White		100
213802	Coaxial Cable CXT PVC Cu/Cu+Al 18VRtC Ø 1.00/4.8/6.6mm White		250
2139	Coaxial Cable CXT PVC Cu/Cu+Al 18VRtC Ø 1.00/4.8/6.6mm Black		100
<b>CU INNER CONDUCTOR / AL BRAID (CLASS A+ TRIPLE SHIELDED)</b>			
<b>EN 50117-2-4 / Eca</b>			
413601	Coaxial Cable SK100plus PVC Eca Class A+ Triple Shielded TSH 18VAAtC Ø 1.02/4.6/6.70mm White		100
413602	Coaxial Cable SK100plus PVC Eca Class A+ Triple Shielded TSH 18VAAtC Ø 1.02/4.6/6.70mm White		250
413603	Coaxial Cable SK100plus PVC Eca Class A+ Triple Shielded TSH 18VAAtC Ø 1.02/4.6/6.70mm White		500

## TRIPLE SHIELDED CABLES

The **Trishield cable** provides the greater immunity against interferences. Its use is recommended in runs with high level of electromagnetic noise.



COVERAGE UP TO **82%**



### SK2020plus (4139xx)

**CLASS A++**  
B2ca

The exceptional cable of triple shielding and high screening attenuation, offered by an A++ class.

In addition, thanks to its LSFH outer sheath, it complies with the CPR in a B2ca euroclass, so it has a very low fire hazard.



### SK2003plus (4140xx)

**CLASS A+**  
Dca



### SK2000plus (4138xx)

**CLASS A+**  
Eca

## OTHER TSH CABLES



### ▲ SK110plus (4137xx)

**CLASS A+**  
Eca



### ▲ SK100plus (4136xx)

**CLASS A+**  
Eca



### ▲ SK6Fplus (4148xx)

**CLASS A+**  
Eca



**➤ MORE INFORMATION ABOUT CPR:**  
[EN.TELEXIS.COM/CPR](http://EN.TELEXIS.COM/CPR)

(1) Braid coverage:  
SK2000plus cable (4138xx) = 82%.  
SK110plus cable (4137xx) = 55%.

**COAXIAL CABLE**

Ref.	Description		
<b>COAXIAL CABLES</b>			
<b>CU INNER CONDUCTOR / AL BRAID / BCT-C-H (CLASS A)</b>			
<b>EN 50117-2-4 / Eca</b>			
2126	Coaxial Cable T-100 PVC Eca Class A 16VAtC Ø 1.13/4.8/6.6mm White		100
212601	Coaxial Cable T-100 PVC Eca Class A 16VAtC Ø 1.13/4.8/6.6mm White		250
212602	Coaxial Cable T-100 PVC Eca Class A 16VAtC Ø 1.13/4.8/6.6mm Black		250
2128	Coaxial Cable CXT PVC Eca Class A 19VAtC Ø 1.00/4.5/6.5mm White		100
212801	Coaxial Cable CXT PVC Eca Class A 19VAtC Ø 1.00/4.5/6.5mm White		250
<b>EN 50117-2-4 / Dca</b>			
212811	Coaxial Cable CXT LSFH Dca Class A 19VAtC Ø 1.00/4.5/6.5mm Grey		250
<b>EN 50117-2-5 / Fca</b>			
212501	Coaxial Cable T-100 PE Fca Class A 16PatC Ø 1.13/4.8/6.6mm Black		100
212502	Coaxial Cable T-100 PE Fca Class A 16PatC Ø 1.13/4.8/6.6mm Black		250
<b>CCS (Cu+Ac) INNER CONDUCTOR / AL BRAID (CLASS A+ TRIPLE SHIELDED)</b>			
<b>EN 50117-2-4 / Eca</b>			
414801	Cable Coaxial SK6Fplus PVC Eca Class A+ Triple Shielded TSH 19VAtC.A Ø 1.00/4.6/6.8mm White		100
414802	Cable Coaxial SK6Fplus PVC Eca Class A+ Triple Shielded TSH 19VAtC.A Ø 1.00/4.6/6.8mm White		250
414803	Cable Coaxial SK6Fplus PVC Eca Class A+ Triple Shielded TSH 19VAtC.A Ø 1.00/4.6/6.8mm White		500
414804	Cable Coaxial SK6Fplus PVC Eca Class A+ Triple Shielded TSH 19VAtC.A Ø 1.00/4.6/6.8mm White		3000
<b>CCS (Cu+Ac) INNER CONDUCTOR / AL BRAID (CLASS A)</b>			
<b>EN 50117-2-4 / Eca</b>			
2127	Coaxial Cable CXT-1 PVC Eca Class A 17VAtC.A Ø 1.00/4.7/6.7mm White		100
212703	Coaxial Cable CXT-1 PVC Eca Class A 17VAtC.A Ø 1.00/4.7/6.7mm White		250
212704	Coaxial Cable CXT-1 PVC Eca Class A 17VAtC.A Ø 1.00/4.7/6.7mm White		500
212701	Coaxial Cable CXT-1 PVC Eca Class A 17VAtC.A Ø 1.00/4.7/6.7mm Black		100
212702	Coaxial Cable CXT-1 PVC Eca Class A 17VAtC.A Ø 1.00/4.7/6.7mm Black		250
<b>EN 50117-2-1 / Eca</b>			
210102	Coaxial Cable CXT-50 PVC Eca Class A 23VAtC.A Ø 0.8/3.8/6.0mm White		250
210202	Coaxial Cable CXT-60 PVC Eca Class A 19VAtC.A Ø 1.00/4.7/6.9mm White		2500
<b>UNDERGROUND CABLES</b>			
<b>CU INNER CONDUCTOR / CU BRAID (CLASS A)</b>			
<b>EN 50117-2-5 / Fca</b>			
2140	Coaxial Cable 1/2" PE Fca Class A 7PRtC Ø 2.7/11.5/15.0mm Black		500
214901	Coaxial Cable TR-165 PE Fca Class A 11PRtC Ø 1.63/7.2/10.1mm Black		250
<b>MICROCABLE</b>			
<b>CU INNER CONDUCTOR / CuSn BRAID (CLASS A/B)</b>			
<b>EN 50117-2-4 / Eca</b>			
210601	Coaxial Cable CXT-5 PVC Eca Class A 24VAtC Ø 0.8/3.5/5.0mm White		150
210603	Coaxial Cable CXT-5 PVC Eca Class B 24VAtC Ø 0.8/3.5/5.0mm White		100
<b>ACCESSORIES</b>			
2145	Professional Coaxial Cable Stripper		10
2162	Coaxial Cable Stripper (Bag B2)		10
212001	Coaxial Cable / Optical Fiber Dispenser, Small model (plastic drums) <sup>(1)</sup>		1
212011	Coaxial Cable / Optical Fiber Dispenser, Large model (plastic drums) <sup>(2)</sup>		1



▲ T-100plus  
214102 / 214104 / 214108

**CLASS A**  
Eca



▲ T-100plus  
215501 / 215502

**CLASS A**  
Fca



▲ CXT-1  
2127

**CLASS A**  
Eca



▲ 1/2" (2140)

**CLASS A**  
Fca



▲ TR-165 (214901)

**CLASS A**  
Fca



▲ 2145



▲ 2162



▲ 2120xx  
(Cable drum not included)

BCT-C-H: Broadcast and Telecommunication Technologies - Coaxial Cable - High.

CENELEC Standard:

EN 50117-2-1: Indoor Cable 5...1000MHz

EN 50117-2-4: Indoor Cable 5...3000MHz

EN 50117-2-5: Outdoor Cable 5...3000MHz<sup>(\*)</sup>

(1) For coaxial cable in 100m plastic drum.

(2) For coaxial cable in 250m plastic drum.

# COAXIAL CABLE

## Coaxial cable: technical specifications

References		41391x	4138xx	4140xx	4137xx	214102 214104 214108	215501 215502	215101	2138xx 2139	4136xx	2126xx	2125xx
Type		SK2020plus	SK2000plus	SK2003plus	SK110plus	T-100plus		T-100plus	CXT	SK100plus	T-100	
		Class A++	Class A+		Class A+	Class A		Class A		Class A+	Class A	
Inner Conductor	Ø mm	1.05	1.02	1.02	1.02	1.13		1.12	1.00	1.02	1.13	
	Material	Cu	Cu	Cu	Cu	Cu		Cu	Cu	Cu	Cu	
	Res. Ohm/Km	22	22	22	22	<20		18	<23	<22	<20	
Dielectric	Ø mm	4.6	4.6	4.6	4.6	4.8		4.7	4.8	4.6	4.8	
	Material	PEE	PEE	PEE	PEE	PEE		PEE	PEE	PEE	PEE	
Over Lapped Foil		Material	B	B	B	C		C	C	B	A	
Braid	Material	CuSn [98% Cu]	CuSn	CuSn	CuSn	Cu		Cu	CCA	Al	Al	
	Coverage %	82	82	55	55	73		73	35	60	77	
	Res. Ohm/Km	<11	10.5	15.0	15.0	<12		≤14	<35	<22	<27	
Anti-migrating Film		No	No	No	No	Yes		Yes	No	No	No	
2 <sup>nd</sup> shielding foil		Yes	Yes	Yes	Yes	No		No	No	Yes	No	
Petro-Jelly		No	No	Non	Non	No		No	No	No	No	
Outer sheath	Ø mm	6.9	6.7	6.7	6.7	6.6		6.6	6.6	6.7	6.6	
	Material	LSFH UV Resistant	PVC	LSFH UV Resistant	PVC	PVC	PE	PVC LSFH	PVC	PVC	PVC	PE
Minimum bending radius	mm	34.5	33.5	33.5	33.5	33		33	33	33.5	33	
Shielding at 1GHz	dB	>105	>95	>95	>95	>85		>85	>75	>95	>85	
Capacitance	pF/m	54	54	54	54	55		55	55	53	52	
Impedance	Ohm	75	75	75	75	75		75	75	75	75	
Velocity Ratio	%	84	84	84	84	82		82	82	82	85	
<b>Attenuations (dB/m)</b>												
Frequency [MHz]	200	0.09	0.09	0.09	0.09	0.08		0.08	0.09	0.09	0.08	
	500	0.14	0.14	0.14	0.14	0.13		0.13	0.14	0.14	0.13	
	800	0.18	0.18	0.18	0.18	0.16		0.16	0.18	0.18	0.16	
	1000	0.21	0.21	0.21	0.21	0.19		0.19	0.20	0.21	0.19	
	1350	0.25	0.25	0.25	0.25	0.22		0.22	0.24	0.25	0.22	
	1750	0.28	0.28	0.28	0.28	0.25		0.25	0.28	0.28	0.25	
	2050	0.31	0.30	0.31	0.31	0.28		0.28	0.30	0.30	0.28	
2300	0.32	0.32	0.32	0.32	0.30		0.30	0.32	0.32	0.30		

References		4148xx	2128 212801	212811	2127xx	210102	210202	210601	210603	2140	214901
Type		SK6Fplus	CXT	CXT-1	CXT-50	CXT-60	CXT-5		1/2"	TR-165	
		Class A+	Class A	Class A	Class A	Class A	Class A	Class A	Class B	Class A	Class A
Inner Conductor	Ø mm	1.02	1.00	1.00	0.80	0.80	1.00		0.80	2.70	1.63
	Material	CCS	Cu	CCS	CCS	CCS	CCS		Cu	Cu	Cu
	Res. Ohm/Km	<110	<23	<120	<140	<95	<37		<37	3.2	<9
Dielectric	Ø mm	4.6	4.5	4.7	3.8	4.7	3.5		11.5	7.2	
	Material	PEE	PEE	PEE	PEE	PEE	PEE		PEE	PEE	PEE
Over Lapped Foil		Material	B	B	A	A	A		C	D	
Braid	Material	Al	Al	Al	Al	Al	TCCAM		Cu	Cu	
	Coverage %	60	79	77	75	77	74	55	53	70	
	Res. Ohm/Km	<30	<31	<30	<32	<30	<28	<35	7	<7.2	
Anti-migrating Film		No	No	No	No	No	No		No	No	
2 <sup>nd</sup> shielding foil		Yes	No	No	No	No	No		No	No	
Petro-Jelly		No	No	No	No	No	No		Yes	Yes	
Outer sheath	Ø mm	6.8	6.5	6.7	6.0	6.9	5.0		15.0	10.1	
	Material	PVC	PVC	LSFH	PVC	PVC	PVC		PE	PE	
Minimum bending radius	mm	34	33	33	30	34.5	25		75	50	
Shielding at 1GHz	dB	>85	>85	>85	>85	>85	>85	>75	>85	>85	
Capacitance	pF/m	53	54	54	54	54	53		55	53	
Impedance	Ohm	75	75	75	75	75	75		75	75	
Velocity Ratio	%	82	82	82	82	82	82		82	84	
<b>Attenuations (dB/m)</b>											
Frequency [MHz]	200	0.10	0.09	0.09	0.11	0.09	0.11		0.11	0.03	0.05
	500	0.15	0.14	0.15	0.18	0.15	0.18		0.18	0.05	0.09
	800	0.19	0.19	0.17	0.23	0.19	0.24		0.24	0.07	0.11
	1000	0.22	0.21	0.23	0.26	0.21	0.26		0.26	0.08	0.13
	1350	0.26	0.25	0.27	0.30	0.25	0.30		0.30	0.10	0.15
	1750	0.29	0.29	0.32	0.35	0.29	0.35		0.35	0.12	0.18
	2050	0.31	0.32	0.35	0.38	0.32	0.37		0.37	0.13	0.19
2300	0.33	0.35	0.37	0.41	0.34	0.39		0.39	0.14	0.24	

<b>Sheath</b>	<b>Enviroment</b>
PVC	Indoor
PE	Outdoor
LSFH	Special (Low Smoke Free Halogen)

<b>Over Lapped Foil composition Environment</b>	
A	Aluminium + Polyester + Aluminium
B	Aluminium + Polyester
C	Copper + Polyester
D	Aluminium + Polypropylene

<b>Other abbreviations</b>			
PE	Polyethylene	Cu	Copper
PEE	Foam Polyethylene	CCS	Copper Clad Steel
PVC	Polyvinyle Chlorhidre	CuSn	Tinned Copper
Al	Aluminium	TCCAM	Tinned Copper Clad Aluminium Magnesium

**DATA ENCLOSURES AND CABLES**

Ref.	Description		
<b>RACKS, ENCLOSURES AND UAP</b>			
<b>RACKS AND ACCESSORIES</b>			
533106	19" Rack Cabinet 6U. Glazed Door and Accesible from the side. Wall/Ground Mount		1
533108	19" Rack Cabinet 8U. Glazed Door and Accesible from the side. Wall/Ground Mount		1
533113	19" Rack Cabinet 13U. Glazed Door and Accesible from the side. Wall/Ground Mount		1
533117	19" Rack Cabinet 17U. Glazed Door and Accesible from the side. Wall/Ground Mount		1
533124	19" Rack Cabinet 24U. Glazed Door and Accesible from the side. Ground Mount		1
533150	Panel for Rack 19" 1RU, Up to 24 "F" connectors		1
533153	T.OX Panel for Rack 19" 1RU, Up to 2x7 "F" connectors		1
533151	Panel for Rack 19" 1RU, Up to 24 "RJ45" connectors		1
533154	Cable Management for Rack 19" 1RU, 5 Holes		1
533156	Cable Management for Rack 19" 1RU, 5 Rings		1
533152	Splice Box for Rack 19" 1RU, Up to 24 "SC" connectors (Depth 230mm)		1
533155	Tray for Rack 19" 2RU (Depth 265mm)		1
533161	Blank Panel for Rack 19" 1RU		1
533163	Blank Panel for Rack 19" 3RU		1
533165	Blank Panel for Rack 19" 5RU		1
533170	Screw Kit for Rack 19": Screw with washer and nut (50 units)		1
<b>ENCLOSURES</b>			
546610	Open Main Terminal Panel for Data/Coaxial Distribution (Up to 24 connections)		1
546701	Data/Coaxial/Fibre Network Terminal Enclosure		1
546620	Coaxial Adapter Support "F" Female - "F" Female, for Panels (Ref. 546610)		1
<b>UAP (USER ACCESS POINT)</b>			
546501	Passive Multiplexer "RJ45" 1Male-9Females with 0,2m LSFH Lead		1
209910	Data Terminal Box with 1 Cat.-6 Female RJ45 Connector		1
<b>DATA CABLES</b>			
<b>CAT 5E</b>			
219502	Data Cable F/UTP Cat.-5E Eca Cu LSFH Ø 6.3mm Grey	<b>G</b>	305
219602	Data Cable U/UTP Cat.-5E Eca Cu LSFH Ø 5.5mm Grey	<b>G</b>	305
219701	Data Cable U/UTP Cat.-5E Fca Cu PE Ø 5.5mm Black	<b>B</b>	305
<b>CAT 6</b>			
212101	Data Cable F/UTP Cat.-6 Dca Cu LSFH Ø 7.2mm Violet	<b>V</b>	500
2199	Data Cable U/UTP Cat.-6 Eca Cu PVC Ø 6.2mm White	<b>W</b>	305
2123	Data Cable U/UTP Cat.-6 Dca Cu LSFH Ø 6.2mm Violet	<b>V</b>	305
212302	Data Cable U/UTP Cat.-6 Dca Cu LSFH Ø 6.2mm Violet	<b>V</b>	1000
212310	Data Cable U/UTP Cat.-6 Eca Cu LSFH Ø 6.2mm Violet	<b>V</b>	305
212201	Data Cable U/UTP Cat.-6 Fca Cu PE Ø 6.2mm White	<b>W</b>	305
<b>DATA CONNECTORS</b>			
209901	Data Connector RJ45 UTP Cat.-6 Female		10
209902	Data Connector RJ45 UTP Cat.-6 Male		100
<b>ACCESSORIES</b>			
209801	Crimping Tool RJ45/RJ11/RJ12 and 4P4C/4P2C		1



▲ 533124  
600 x 1200 x 600mm



▲ 533161



▲ 533154



▲ 533151



▲ 533150



▲ 546601  
300 x 340 x 265mm



▲ 546701  
600 x 500 x 80mm

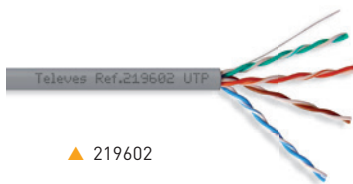

▲ 219602

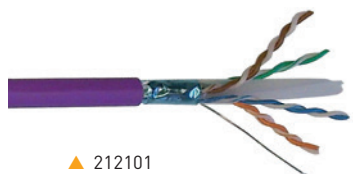

▲ 212101



▲ 546501



▲ 209910



▲ 546620



▲ 209901



▲ 209902

# SET TOP BOXES & HOME ACCESSORIES

Ref.	Description	
<b>DTH STBs</b>		
<b>SATELLITE TV</b>		
7118	Satellite Digital Set-top Box FTA with Modulator (FreeSat)	1/5
717501	Satellite Digital Set-top Box FTA "zAs HD SAT" (FreeSat)	1/10
<b>MODULATOR</b>		
5858	Domestic Modulator with Display (VHF/UHF)	1
585801	Domestic Modulator with Display (VHF/UHF) (UK Plug)	1
4377	SCART-2RCA Cable Male-Male 1.5m Black (Blister L)	10
<b>AUDIO/VIDEO &amp; IR TRANSMISSION</b>		
7167	Digidom Transmitter + Receiver Audio/Video 5.8GHz 8 Channels	1/10
<b>IR OVER RF TRANSMISSION</b>		
723702	Digidom Universal Transmitter + Receiver, Remote Control Extender, 8 Channels	1/30
721902	Digidom Universal Transmitter, Remote Control Extender, 8 Channels	1/30
<b>IR OVER COAXIAL CABLE TRANSMISSION</b>		
7605	Transmitter + Receiver Remote Control Extender over Coaxial Cable	1/6
7606	Single Transmitter Remote Control Extender over Coaxial Cable	1/10



▲ 7118



▲ 717501



▲ 5858



▲ 7167



▲ 723702



**TOOLS**

Ref.	Description	
<b>FIBER OPTICS</b>		
<b>KITS</b>		
232130	F.O Kit: Arc Fusion Handheld Splicer + Stripper + Cleaver	1
232103	F.O Kit: Arc Fusion Splicer + Stripper + Cleaver + Accessories for fusioning Connectors <sup>(1)</sup>	1
2341	F.O Kit: Connector & Mechanical Splicer + Stripper (Ref. 2324) + Cleaver (Ref. 232301) + Cleaning Tools <sup>(2)</sup>	1
<b>ACCESSORIES</b>		
2327	Splicing Protection Sleeve 60mm for Fiber Optics Fusion (for Fusion Splicer)	200
232701	Splicing Protection Sleeve 43mm for Fiber Optics Fusion (for Fusion Splicer)	200
2322	Mechanical Splicer of Fiber Optics	1
2328	Mechanical Splices of Fiber Optics (for Mechanical Splicer)	10
232301	Cleaver of Fiber Optics	1
232310	Kevlar Scissors for Optical Fibers	1
2325	Stripper for Multi-fiber Cables	1
2324	Precision Stripper for Optical Fibers	1
2329	Connectors of Fiber Optics "SC/APC" (with mounting tool)	10
232910	Cleaner for Fiber Optic Connectors	1
232710	F.O. Cleaning Kit: 50 isopropyl alcohol Wipes + 25 Sticks	1
<b>SIGNAL GENERATORS</b>		
2340	OPS3L Triple Light Source (1310, 1490 & 1550nm)	1
4008	SAT Simulator 950...2150MHz	1
593001	SAT Simulator and Noise Generator 5...3000MHz	1
7301	SAT Finder 950...2050MHz	1



▲ 232130



▲ 2341



▲ 4008



▲ 593001



▲ 232301



▲ 232910



▲ 232103



▲ 2325

(1) Also includes: Spare set of electrodes, tweezers and carrying case.

(2) Also includes: ref. 2328 (5 units), ref.2329 (10 units), ref.232910 (1unit and a replacement reel), 10 isopropyl alcohol wipes, 10 sticks for connectors cleaning & carrying bag.

Ref.	Description	
<b>FIELD STRENGTH METERS</b>		
<b>H30FLEX</b>		
593301	H30FLEX: DVB-S/S2 + DVB-T	1
593302	H30FLEX: DVB-S/S2 + DVB-T/T2	1
593303	H30FLEX: DVB-S/S2 + DVB-C	1
593304	H30FLEX: DVB-S/S2 + DVB-T/T2 + DVB-C	1
<b>H30FLEX OPTIONS</b>		
593231	Option DVB-T	1
593232	Option DVB-T2 (DVB-T required)	1
593233	Option DVB-C	1
593234	Option dCSS	1
593235	Option Extended Terrestrial Input to 120dBμV	1
<b>H30 (DVB-C)</b>		
593102	H30: DVB-C + Remote Control (Ethernet) + IP Speed Test	1
593104	H30D3: DVB-C + Remote Control (Ethernet) + IP Speed Test + DOCSIS 3.0	1
<b>H30/H30D3 OPTIONS</b>		
593210	Option MPEG Service Information	1
<b>H30FLEX / H30 / H30D3 ACCESSORIES</b>		
593201	Protective Sleeve (Included by Default in H30 and H30D3 models)	1
<b>H45 COMPACT</b>		
599020	H45 COMPACT: Full HD + CI	1
599021	H45 COMPACT: Full HD + CI + DVB-T2	1
599022	H45 COMPACT: Full HD + CI + F.O.	1
599023	H45 COMPACT: Full HD + CI + Selective F.O. (CWDM Filter)	1
599024	H45 COMPACT: Full HD + CI + DVB-T2 + F.O.	1
599025	H45 COMPACT: Full HD + CI + DVB-T2 + Selective F.O. (CWDM Filter)	1
<b>H45 COMPACT OPTIONS</b>		
598901	Option DVB-T2 <sup>(1)</sup>	1
5999	Option Fiber Optic Interface <sup>(1)</sup>	1
599902	Option Selective Fiber Optic Interface (CWDM Filter) <sup>(1)</sup>	1
5909	Calibration of H-Series Spectrum Analyzer (Certificate Included) <sup>(1)</sup>	1
<b>H45 ACCESSORIES</b>		
5995	Weatherproof Bag	1
405701	Twin Adaptor "EasyF" Male - "F" Female	10
<b>MOSAIQ6</b>		
596101	MOSAIQ6: DVB-T/T2 + DVB-S/S2 + DVB-C + ISDB-T/Tb, CI, F.O.	1
596111	MOSAIQ6: DVB-T/T2 + DVB-S/S2 + DVB-C + ISDB-T/Tb, CI, Selective F.O. Interface (CWDM Filter)	1
<b>MOSAIQ6 OPTIONS</b>		
596201	Option GPS Drive Test	1
596202	Option WiFi 5GHz	1
596203	Option Analogue Measures	1
596204	Option DAB/DAB+	1
596205	Option 4K - Ultra High Definition (UHD)	1

## MOSAIQ6



Portable meter with high performance and high accuracy for professional installers.

### THE POWER OF USER EXPERIENCE

#### 6 SCREENS IN 1

Thanks to its configurable interface, you choose which widgets (up to 6) you want to simultaneously display in the 8" high resolution screen. Check the installation status at a glance.

#### A TRUE TOUCH SCREEN

This new interface has been designed and also programmed to take full advantage of a touch screen with touch gestures (tap, double tap, long press, drag, spread or pinch). Only in this way is it possible to operate so easily a meter with so many performances.



SCAN TO WATCH THE VIDEO  
EN.TELEVES.COM/MOSAIQ6



▲ H45 Compact



▲ H30D3

▲ H30

▲ H30FLEX

(1) Upgrades to be done in Factory.



# H30FLEX

MULTI STANDARD **HANDHELD METER**



-  LICENCED CUSTOMIZABLE OPTIONS
-  HD CHANNELS DISPLAY
-  SPECTRUM ANALYSER
-  MADE IN EUROPE
-  dCSS (SCR) COMPATIBLE

## ALL THE FUNCTIONS YOU NEED IN YOUR HAND

Choose the standards you're actually going to measure and only pay for the features you need.

Ref.	Description	
<b>COAXDATA SERIES</b>		
<b>GIGABIT: 1Gbps</b>		
769301	Transmitter/Receiver Router 1Gbps-HDTV Data over Coaxial, PLC and WiFi (Low Power WiFi option), 3 Ethernet Connectors & 2 "F" Connectors	1
769201	Transmitter/Receiver 1Gbps-HDTV Data over Coaxial and PLC, 2 Ethernet Connectors & 2 "F" Connectors	1
769202	Transmitter/Receiver 1Gbps-HDTV Data over Coaxial and PLC, 1 Ethernet Connector, 1 SFP (Optical Fiber) Connector & 2 "F" Connectors	1
769203	Transmitter/Receiver 1Gbps-HDTV Data over Coaxial, 1 Ethernet Connector & 2 "F" Connectors	1
769330	Coaxbox Coaxdata Management Device	1
<b>ACCESSORIES</b>		
769210	Ethernet - SFP Adapter 1000Base-X 2 Fibers, Point to Point (Media Converter)	1
769220	Diplexer Filter 2i/1o "F": LPF (2...68MHz) - HPF (87...2150MHz)	1/10
7653	Diplexer Filter 2i/1o "EasyF": LPF (1...25MHz) - HPF (47...2150MHz)	1/10
7654	Diplexer Filter 2i/1o "EasyF": LPF (1...40MHz) - HPF (47...2150MHz)	1/10
7668	Diplexer Filter 2i/2o "EasyF": LPF (1...25MHz) / HPF (47...2150MHz) - HPF (47...2150MHz)	1/10
640301	Wall Mount (for CoaxData ref. 769301)	1
<b>FIBREDATA SOLUTIONS: GPON (Gigabit-capable Passive Optical Networks)</b>		
<b>GPON HEADENDS</b>		
769401	OLT512: 8x PON + 4x Gb Ethernet + 4x 10GbEthernet/Gb Ethernet (Up to 512 users) <sup>(1)</sup>	1
769420	Modular OLT3072, for 3 16xPON cards and 2 2x10Gb switch cards, (Up to 3072 users) <sup>(1)</sup>	1
769421	2x10Gb Switch Card (for OLT3072, Ref. 769420)	1
769422	16xPON Card (for OLT3072, Ref. 769420)	1
769601	Double Power Supply Unit -48Vdc. 19" Rack Mount, 1RU (for OLT)	1
769410	SFP GPON B+ 1 Fiber "SC/PC"	1
769413	SFP GPON C+ 1 Fiber "SC/PC"	1
769411	SFP Gb Ethernet "RJ45"	1
769412	SFP 10Gb Ethernet 2 Fibers	19
<b>VIDEO OVERLAY HEADENDS: T.OX SERIES</b>		
234801	T.OX Optical Transmitter 1310nm "SC/APC" Po 10dBm w/o Return Path RF Automatic Adjustment and Temperature Stability	1
234305	T.OX Optical Transmitter 1550nm "SC/APC" Po 4dBm w/o Return Path	1
234806	T.OX Optical Transmitter MATV 1550nm "SC/APC" Po 6dBm w/o Return Path External modulation and RF Automatic Adjustment (up to 30Km)	1
234811	T.OX Optical Transmitter 1550nm "SC/APC" Po 10dBm w/o Return Path RF Automatic Adjustment and Temperature Stability	1
769610	Optical Amplifier / Multiplexer 8o: "SC/APC" 20dBm (YEDFA Technology) + Double Power Supply Unit -48Vdc. 19" Rack Mount, 1RU (for OLT)	1
769611	Optical Amplifier / Multiplexer 32o: "SC/APC" 20dBm (YEDFA Technology) 19" Rack Mount, 2RU	1
234228	T.OX Optical Amplifier / Multiplexer "SC/APC" 20dBm (YEDFA Technology) 9i: 8x1310/1490nm - 1x1550nm, 8o: 8x1310/1490/1550nm	1
5629	T.OX Switch-mode Power Supply Unit 120W 24V-5A	1
563901	T.OX Switch-mode Power Supply Unit 120W 24V-5A (110Vac & UL Listed)	1
2337	T.OX Optical Splitter 1260...1650nm "SC/APC" 2W 4dB	1
2339	T.OX Optical Splitter 1260...1650nm "SC/APC" 4W 7dB	1
234401	T.OX Optical Splitter 1260...1650nm "SC/APC" 8W 10dB	1
234501	T.OX Optical Splitter 1260...1650nm "SC/APC" 16W 14dB	1
234601	T.OX Optical Splitter 1260...1650nm "SC/APC" 32W 17dB	1



▲ 769610



▲ 769611

**COAXDATA SERIES**



▶ 769301

**MULTIMEDIA SERVICES INTEGRATION OVER EXISTING COAXIAL NETWORKS**

Televes' Mynet WiFi technology allows you to configure your CoaxData Wireless Access Point in low power mode, hence the possibility to create network access microcells providing an improved performance to all users connected.



▲ 769201

**FIBREDATA SOLUTIONS**

**TELEVES COST-EFFECTIVE QUAD PLAY SOLUTIONS OVER OPTICAL FIBRE**



▲ ONT

▶ ONU



▶ OLT3072



▶ OLT512

**Compact, reliable, affordable and easy to manage GPON and RF overlay products.**

Multiple-play service enabling high speed data, VoIP, 802.11 Ac Wi-Fi, video (IPTV and RF overlay) Poe, etc.



▶ CONSULT OUR FIBREDATA BROCHURE: [EN.TELEVES.COM/FIBREDATA](http://EN.TELEVES.COM/FIBREDATA)

Ref.	Description	
<b>FIBREDATA SOLUTIONS: GPON (Gigabit-capable Passive Optical Networks)</b>		
<b>DISTRIBUTION</b>		
233750	Optical Splitter, PLC Component, 1260...1650nm "SC/APC" 2W 4dB	1
233950	Optical Splitter, PLC Component, 1260...1650nm "SC/APC" 4W 7dB	1
234450	Optical Splitter, PLC Component, 1260...1650nm "SC/APC" 8W 10dB	1
234550	Optical Splitter, PLC Component, 1260...1650nm "SC/APC" 16W 14dB	1
234650	Optical Splitter, PLC Component, 1260...1650nm "SC/APC" 32W 17dB	1
231502	F.O. Patch/Splitting Box 2 to 4 Outs	1
232622	F.O. Patch Cord Single-mode LSFH Pre-terminated "SC/APC"-"SC/PC" 0.2m	5
232621	F.O. Patch Cord Single-mode LSFH Pre-terminated "SC/APC" 2m (Bag B4)	10
236410	Optical Attenuator 1310/1550nm "SC/APC" 2dB	1
236411	Optical Attenuator 1310/1550nm "SC/APC" 5dB	1
236412	Optical Attenuator 1310/1550nm "SC/APC" 10dB	1
234740	Optical WDM 1i/2o "SC/APC" Data (1310/1490) - TV(1550nm) in box 231501	1
<b>CUSTOMER PREMISE EQUIPMENT: ONT (Optical Network Terminal)</b>		
769507	ONU Basic Module: 1x GB Ethernet	1
769508	ONU Standard Module: 1x GB Ethernet, RF Overlay	1
769501	Office ONT Module: 4x GB Ethernet + 2x FXS + 2x USB, WLAN b/g/n	1
769506	Office AC ONT Module: 4x GB Ethernet + 2x FXS + 2x USB, WLAN b/g/n/ac	1
769502	Home ONT Module: 4x GB Ethernet + 2x FXS + 2x USB, WLAN b/g/n, RF Overlay	1
769504	Home ONT Module: 4x GB Ethernet + 2x FXS + 2x USB, WLAN b/g/n/ac, RF Overlay	1
<b>OPTICAL MICRO-NODES</b>		
231111	Domestic Optical Receiver 1550nm "SC/APC" with Amplifier 47...1006MHz, OLC Technology (Optical Level Control)	1



▲ 234650



▲ 231502



▲ 232622  
(Adaptation among APC and PC)



▲ 231111

### Technical Characteristics: ONT + ONU



References	769501	769506	769502	769504	769507	769508	
<b>Models</b>	<b>ONT</b>				<b>ONU</b>		
	OFFICE	OFFICE	HOME	HOME	BASIC	STANDARD	
RF-Overlay	✗	✗	✓	✓	✗	✓	
WiFi (802.11 b/g/n) (2x2) 2.4	✓	✓	✓	✓	✗	✗	
WiFi (802.11 b/g/n/ac) (2x2) 2.4/5	✗	✓	✗	✓	✗	✗	
USB	2	2	2	2	✗	✗	
FXS Ports	2	2	2	2	✗	✗	
ETH 10/100/1000BASE-T Ports	4	4	4	4	1	1	
NAT/NAPT	✓	✓	✓	✓	✗	✗	
Firewall	✓	✓	✓	✓	✗	✗	
VPN pass-through	✓	✓	✓	✓	✗	✗	
PPPoE Terminal	✓	✓	✓	✓	✗	✗	
OMCI	✓	✓	✓	✓	✗	✗	
TR-069	✓	✓	✓	✓	✗	✗	
CLI	✓	✓	✓	✓	✗	✗	
WebGUI	✓	✓	✓	✓	✗	✗	
<b>General</b>							
Temperature conditions	°C	-5...65				-5...65	
	°F	23...149				23...149	
Relative humidity	%	0..95				0..95	
Power consumption	W	19	19	19	19	7	7
Dimensions (Width x Hight x Depth)	mm	210 x 40 x 210				142 x 30,5 x 112	
	inch	8.25 x 1.57 x 8.25				5.57 x 1.20 x 4.4	

(1) AC/DC Adapter included.

# ARANTIA.TV

## ▶ IPTV AND INTERACTIVE TELEVISION ◀

ARANTIA TV INCLUDES ALL THE SERVICES NEEDED to respond to its customers' requirements within a simple IPTV platform in all kinds of projects, including hotels, hospitals, operators, companies and residential buildings. Indeed, it provides additional **new tools in order to enhance business operations.**

- **Two Middleware Versions available:** Chronos STB Middleware and LG and Samsung televisions Middleware \*.
- **Multiple Interactive Services:** Television, Video on Demand, News, Messages, Check Expenses, Information Services...
- **Powerful System Management Tool.**
- **Integration with Arantia DS.**
- **Third party systems integration:** Property Management Systems, NO/NC Alarm Systems.
- **User Interface that can be customized** according to each project requirements.

\* Check compatible TV models.

Ref.	Description	
<b>COMPACT HE-21 IPTV HEADEND</b>		
831010	HE-21 4U Chassis	1
831011	HE-21 4U Chassis with Redundant Power Supply	1
831012	HE-21 1U Chassis	1
831110	HE-21 DVB-S/S2 Dual Input	1
831111	HE-21 DVB-S/S2 Quad Input	1
831115	HE-21 DVB-T/T2 Dual Input	1
831114	HE-21 DVB-T/T2 Quad Input	1
831123	HE-21 DVB-S/S2/T/T2/C/ISDB-T Dual Input with Dual CI	1
831121	HE-21 ATSC Quad Input	1
831118	HE-21 DVB-IP Input	1
831122	HE-21 HDMI Quad Input	1
831119	HE-21 Corporate Channel License	1
830318	HE-21 Arantia TV Middleware up to 50 Users	1
830325	HE-21 Middleware Lite & STB/TV Management Tool	1
<b>ENCODERS / TRANSCODERS</b>		
832103	Encoder 8 HDMI Inputs MPEG4 IP	1
832201	Transcoder/Streamer Live	1
<b>ITV HEADEND (INTERACTIVE TELEVISION)</b>		
830320	Arantia TV Middleware up to 100 Users	1
830321	Arantia TV Middleware from 101 to 499 Users	1
830322	Arantia TV Middleware from 500 to 1000 Users	1
830323	Arantia TV Middleware over 1000 Users	1
830319	Arantia TV Set-Top Box License	1
830507	Arantia TV Television License	1
830311	VOD Server 20 Streams 1TB SATA	1
8303201	VOD Server 95 Streams 500GB (1.2TB) SAS	1
8303203	VOD Server 95 Streams 1TB (2.4TB) SAS	1
830316	IPTV Remote Management Server	1
832001	Server Upgrade to Redundant Power Supply	1
<b>ITV PERSONALIZATION &amp; OPTIONS</b>		
830501	Property Management System Interface	1
830502	User Interface Personalization Manager	1
830103	Chronos Alarm Monitor	1
830506	NO/NC Alarm System Integration	1
831310	Payment Terminal Kiosk	1

## IPTV HE-21 HEADEND



Arantia IPTV HE-21 headend allows the reception of digital services through its DVB-T/T2, DVB-S/S2, DVB-C, ISDB-T, ATSC, HDMI & IP input modules that are encapsulated in IP packages and streamed through an IPTV network.

- **Cost-effective:** Adjusted price taking into account all the features that incorporates, such as the Session Announcement Protocol (SAP) or Universal Plug and Play (UPnP).
- **High Density:** Many inputs and software options in a reduced space of 4U.
- **Multi-Standard:** Support for most of the European and American Digital TV (DTV) standards.
- **Web Administration.**
- **Descrambling** with DVB-CI.
- **HEVC & 4K** compatible.
- **Optional Products:** Corporate Channel Licence and Interactive Services Middleware.

## TRANSCODER LIVE



### TELEVISION AT YOUR FINGERTIPS

Arantia Multiscreen Transcoder (Ref.832201) allows you to send television channels to any device (Smartphones, Tablets, STB, PC, Smart TV,...) through any kind of network.

- Two functions on a single equipment: Transcoding and Streaming.
- Adaptive streaming.
- HEVC Compatibility.
- Up to 4K (2160p) output resolution.
- Casting services compatible.

Arantia TV: Main System Components

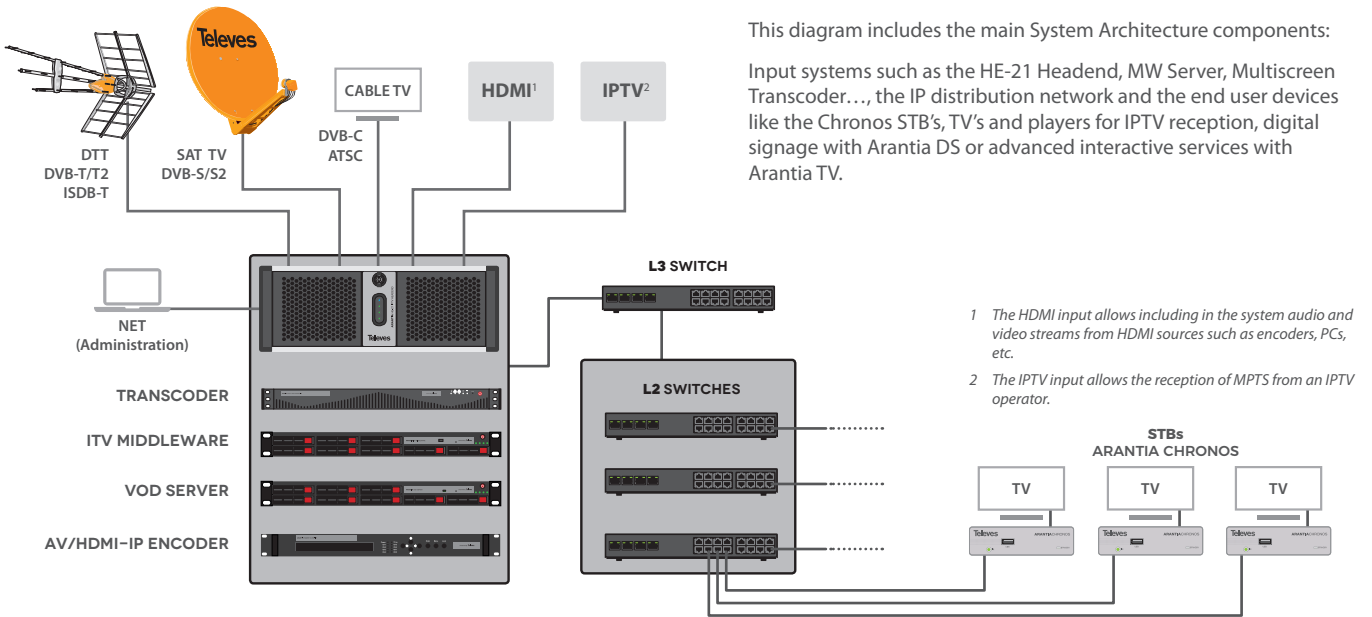

Ref.	Description	
<b>IPTV - ITV IN ROOM EQUIPMENT</b>		
830102	Chronos Set-Top Box	1
830104	Chronos Set-Top Box WiFi	1
830105	Chronos Set-Top Box PoE	1
830207	Universal Remote Control	1
830210	Premium Universal Remote Control	1
830209	Power Supply Unit for Set-Top Box (EU plug)	1
830208	Power Supply Unit for Set-Top Box (UK plug)	1
830203	Set-Top Box IR Extension	1
830213	Set-Top Box TVI Extension - Samsung	1
830215	Set-Top Box TVI Extension - LG	1
831504	CAT6 UTP Cable 1m	1
830212	Set-Top Box Wall Mounting Kit	1
830205	Vesa 200x200mm Set-Top Box Wall Mount	1
<b>IPTV - ITV ACCESSORIES</b>		
831304	19" Rack 22U Mounted & Adjusted	1
831301	19" Rack 27U Mounted & Adjusted	1
831302	19" Rack 37U Mounted & Adjusted	1
831303	19" Rack 42U Mounted & Adjusted	1
831311	Rack Rails for HE-21	1
831404	VPN Router	1
831701	Uninterruptible Power Supply (UPS)	1
831401	Layer 3 Ethernet Switch 1000TX 24 Ports + 4 SFP Ports	1
831405	Layer 3 Switch 24 Ports 1000TX/SFP Combo	1
831406	Layer 2+ Ethernet Switch 1000TX 24 Ports + 4 Ports SFP	1
831402	Layer 2 Ethernet Switch 100TX 24 Ports + 2 Ports 1000TX + 2 Ports SFP	1
831403	Layer 2 Ethernet Switch 100TX 48 Ports + 2 Ports 1000TX + 2 Ports SFP	1
831408	Layer 2 Ethernet Switch 100TX 24 Ports PoE + 4 Ports SFP	1
831407	Layer 2 Ethernet Switch 100TX 48 Ports PoE + 4 Ports SFP	1
831503	Transceiver 1000SX SFP LC MMF (Multi-Mode Fibre)	1
831506	Transceiver 1000LX SFP LC SMF (Single-Mode Fibre)	1
831505	Transceiver 1000T SFP RJ-45	1



▲ 830102



▲ Rack 27U (Mounted and adjusted)



# ARANTIA.DS

Promote your business in a simple, intuitive and profitable way through attractive multimedia content thanks to Arantia DS.

Create, manage and deliver attractive, flexible and tailor made information to different Digital Signage Players through the system management tool.



## DIGITAL SIGNAGE SOLUTION FOR YOUR BUSINESS

### MAIN FEATURES:

- Web based Management Tool.
- Scalable solution.
- Cloud based & in-house Server architecture.
- Users and groups management.
- DS Players Management.
- Media library Management.
- Secured Content Download.
- Templates and Content Designer.
- Content Carousels.
- Smart Content Scheduling.
- Displays Switch ON / OFF Scheduling.
- Room Booking Application.

Ref.	Description	
<b>DIGITAL SIGNAGE CLOUD</b>		
831810	Chronos DS Player	1
831812	Nemesis DS Player	1
831801	Totem with Vertical Display DS Player	1
831811	DS Annual Cloud Hosting per Player	1
830209	Power Supply Unit for Set-Top Box (EU plug)	1
830208	Power Supply Unit for Set-Top Box (UK plug)	1
830213	Set-Top Box TVI Extension - Samsung	1
830215	Set-Top Box TVI Extension - LG	1
<b>LOCAL DIGITAL SIGNAGE</b>		
831805	Arantia DS Server up to 150 Users	1
831810	Chronos DS Player	1
831812	Nemesis DS Player	1
831801	Totem with Vertical Display DS Player	1
830209	Power Supply Unit for Set-Top Box (EU plug)	1
830208	Power Supply Unit for Set-Top Box (UK plug)	1
830213	Set-Top Box TVI Extension - Samsung	1
830215	Set-Top Box TVI Extension - LG	1

### DS NEMESIS STB



#### THE NATURAL EVOLUTION OF STB'S

Nemesis STB is the natural evolution of Chronos as a Digital Signage Player for Arantia DS.

- With the same shape as the Chronos STB, it is a powerful and reliable STB with low power consumption and better performance.
- It supports vertical and horizontal orientation, which is very useful for certain types of contents.
- It includes expandable storage via microSD.



Arantia DS: Cloud based & in-house Server based operation modes

Arantia DS offers two operation modes through a Cloud based or an in-house Server based architecture:

**CLOUD BASED ARANTIA DS:** The core DS management application is hosted inside Televes Cloud infrastructure and the distributed DS Players access to it from any place with Internet access.

► **This architecture is perfect** for distributed DS systems with some DS Players in different locations.

**IN-HOUSE SERVER BASED ARANTIA DS:** The core DS management application and the DS Players are located in the same local area network.

► **This architecture is perfect** for DS systems where the number of DS Players located in the same local network is high.

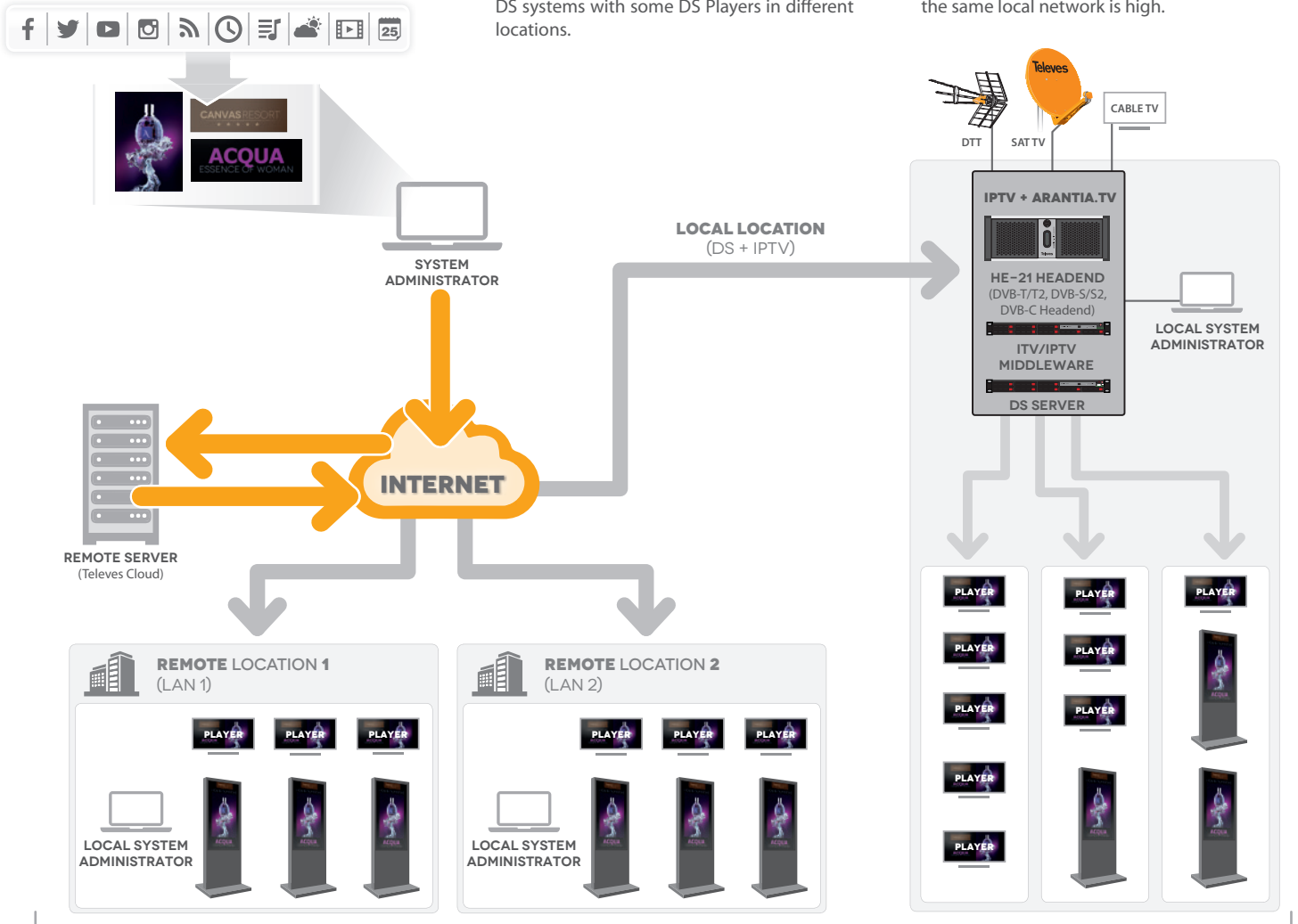

DS TOTEM

A NEW POWERFUL TOOL FOR DIRECT COMMUNICATION

ArantaDS Totem provides a new powerful tool for direct communication with your audience, fully integrated in the establishment environment at any location thanks to its innovative and customized design.

- It allows to display different types of digital information (information on events, addresses, advertisement and promotion) at one signalling point.
- It offers the possibility of customization, emphasizing the company's corporate image.
- It is made up of a light extruded aluminium chassis with a slim and sophisticated design.
- It has a IPS FHD 55" screen with integrated audio and Smart Energy Saving, specially conceived for Digital Signage, with a 24/7 operation mode and electronic protection against external agents as dust and humidity.
- It offers an optimal view of the displayed contents thanks to the frontal extra clear laminated glass.

Ref.	Description	
<b>ARANTIACAST</b>		
831410	ArantiaCast Server Pack	1
831411	ArantiaCast Chromecast	1

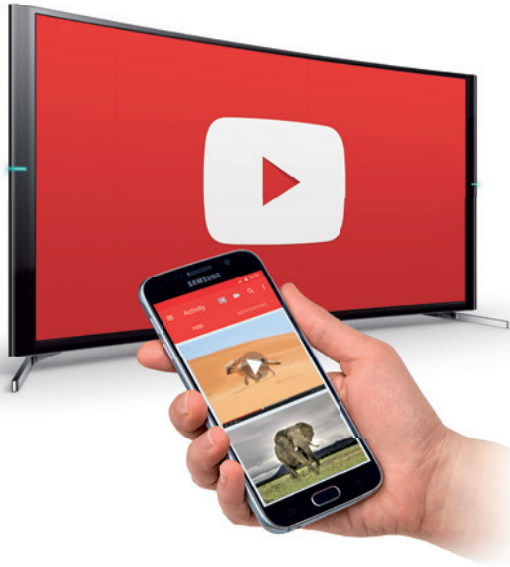

## ARANTIACAST

### DESCRIPTION

There are two options for the display of a mobile device's contents on a television screen:

The **MIRRORING** system directly projects the mobile device's screen on the television set. Therefore, the applications associated with the display of the contents are run on the mobile device itself, preventing it from simultaneously executing other applications. In case a call is received while surfing the Internet, for example, the image produced as a result of that call will be displayed on the TV set display.

The **CASTING** system, rather than projecting the smartphone screen on the television set, actually transfers the application that is being executed. Once an app is initiated on the smartphone, it can be sent to Chromecast, which will take care of its execution from then on, freeing the mobile device and allowing it to receive calls or execute other applications. The Google Chromecast-based casting is compatible with over 1,000 applications.

### HIGHLIGHTS

- The system allows the advanced remote monitoring of the installed devices
- The Chromecast installation on the television sets is carried out in an unobtrusive and safe way
- Streaming will only be allowed on the television set of the guest's own room
- Disconnection from the system takes place on checkout

**ARANTIACAST** is a casting system that allows each user in a multiuser environment, such as hotels, to have its own exclusive associated device. Without any login or password, and with automatic disconnection when the guest checks out through the hotel's PMS.

The unobtrusive installation does not detract from any aesthetic or functional aspect of the room. It only needs to be integrated in the premises' existing Wi-Fi network. Furthermore, it allows network remote monitoring and provides an outstanding added value to the hotel.

#### MAIN FEATURES:

- Content streaming on the hotel's television set, just like home
- No login, password or personal information from the guest required
- Compatible with any television set equipped with an HDMI connector
- Over 1,000 applications available for Casting (Netflix, HBO, Youtube, etc.)
- Multiple mobile devices can be connected to the same room's Chromecast

#### Differences between ARANTIACAST and mirroring

ARANTIACAST	MIRRORING
The contents of an application are transferred to a different device	The image displayed on an application is transferred to a different device
Both devices can run different applications	The same screen is displayed on both devices
The device to which the application is transferred only displays the application's execution	All the content displayed on the portable device is displayed on the second device's screen
Multitasking: the mobile device can run other applications	No multitasking: all the actions performed on the mobile device are displayed on the secondary device.
The mobile device's screen can be disabled, left idle.	Should the screen of the mobile device turn black, so would the screen of the secondary device.
Not all apps are compatible	Everything can be displayed on the screen of the secondary device.
For the time being, few applications allow the transfer of local content	Allows application execution in local mode

# STREAMING EXPERIENCE

THE GUEST WILL FEEL AT HOME

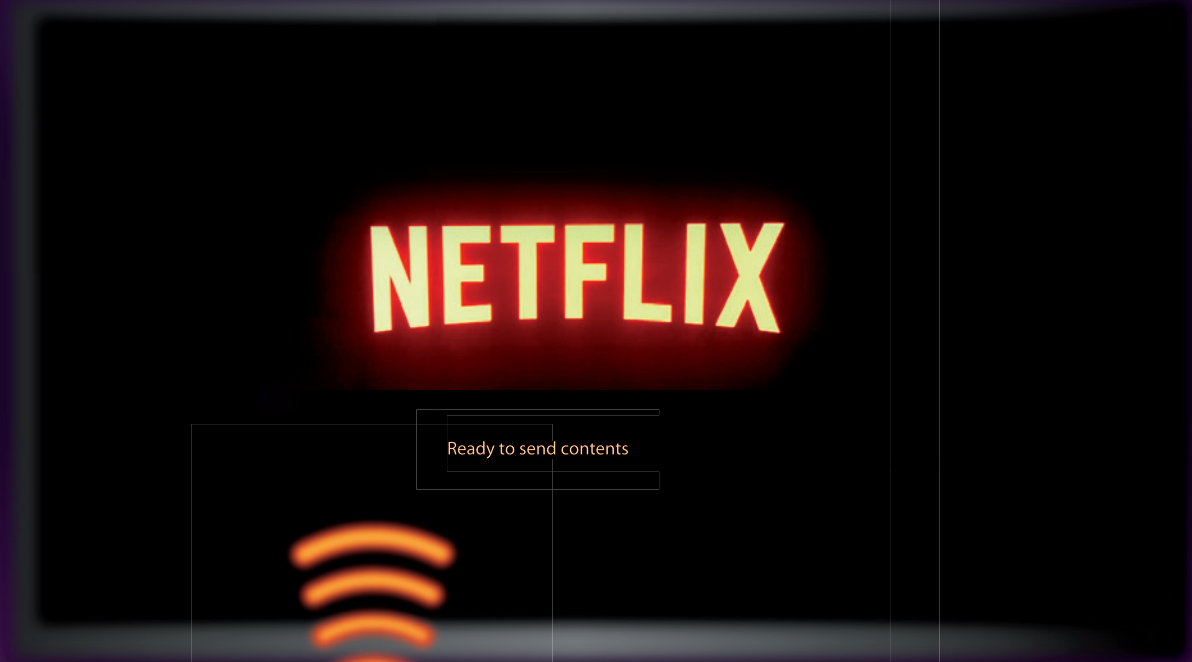

## ARANTIACAST

THE COMPLETE CONTENTS OF THE MOBILE DEVICES  
ON THE HOTEL TV SET

*Over 1,000 apps available*

[chromecast.com/apps](http://chromecast.com/apps)

STAYCAST™ streaming solution powered by Google Chromecast  
Android, IOS, and ChromeOS compatible





## Technology brings us together

Teledes Corporation is the core of a group of technology firms, a leader in the design and development of equipment for all kinds of telecommunications infrastructures for homes, buildings and cities.

Teledes Corporation consists of over 20 firms working together towards the common objective of designing, developing and manufacturing in Spain a series of high-quality products and solutions for the telecommunications industry.

Teledes Corporation is present in over 100 countries, with its 11 subsidiaries (Spain, Portugal, France, United Kingdom, United Arab Emirates, Italy, United States, Germany, China, Poland, Russia, Scandinavia) and its wide network of professional distributors.