

UK

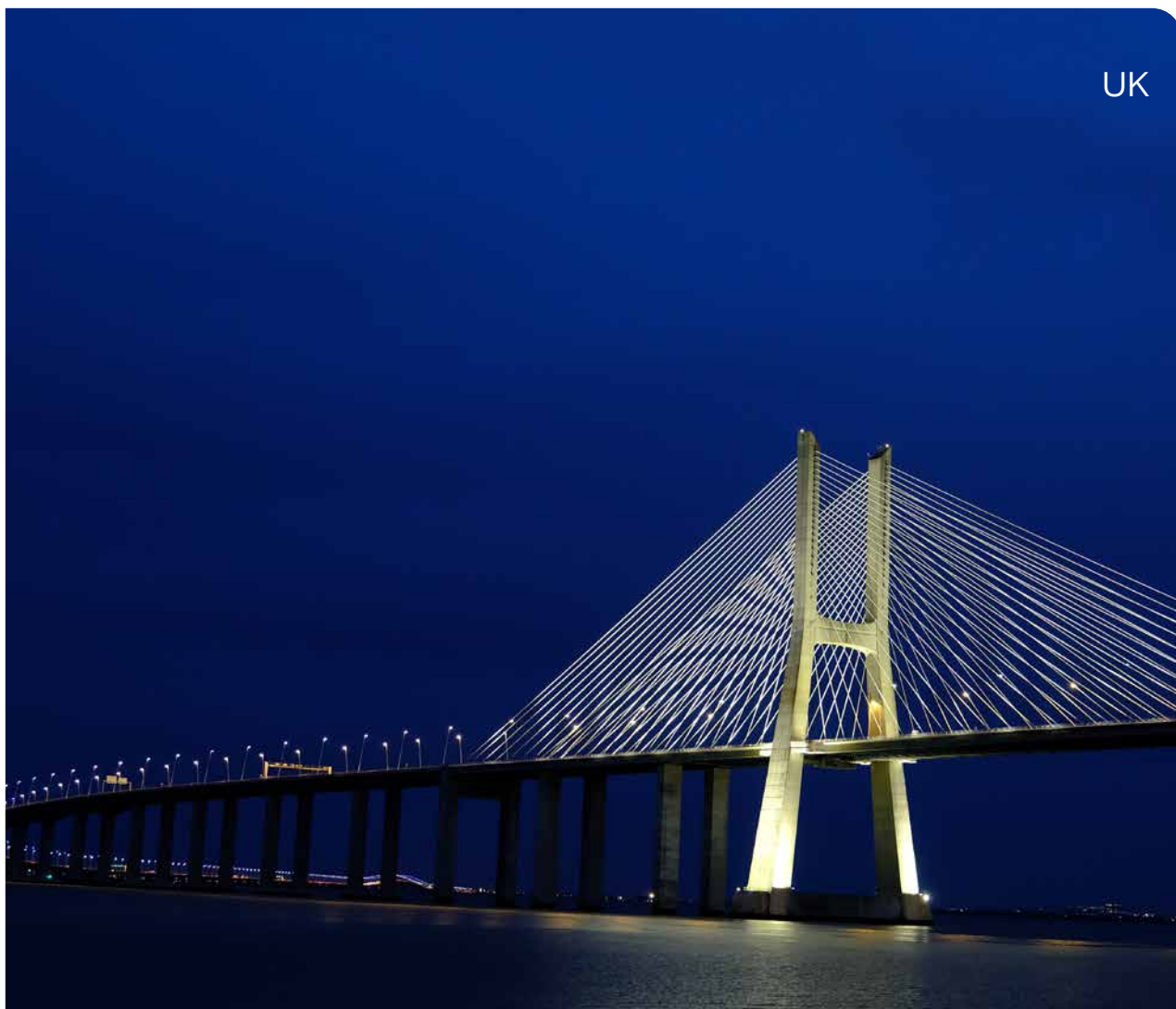

PROFESSIONAL LED LIGHTING

PRODUCT GUIDE 2024

FROM 01/01/2024

Televes[®]

INTERURBAN OUTDOOR LIGHTING	3
CIES	5
ATMOSLED	7
ACCESSORIES	8
URBAN AND RESIDENTIAL OUTDOOR LIGHTING	9
URBAN ALAMEDA.....	11
URBAN MAIA.....	11
ORNAMENTAL LAMPS	13
AROUSA LAMPS	15
ACCESSORIES	16
ROAD SAFETY LIGHTING	17
CIES CROSSWALK	19
MOTION SENSORS.....	19
ACCESSORIES	19
FLOODLIGHTS	21
SPORT OR LARGE AREAS	23
ARCHITECTURAL AND ARTISTIC FLOODLIGHTING	26
ACCESSORIES	27
BOLLARDS	28
AROUSA	29
ACCESSORIES	29
INDUSTRIAL INDOOR LIGHTING	30
INNERLED	31
ZAR HIGH-BAY LAMP.....	32
ACCESSORIES	33
LIGHTING RENOVATION (RETROFIT)	34
RETROFIT COMPONENT.....	36
RETROFIT Q COMPONENT.....	36
ACCESSORIES	37
REMOTE MANAGEMENT	38
ELECTRICAL SWITCHBOARD CONTROL	39
POINT TO POINT CONTROL	39
AURANT LIGHTING PLATFORM.....	39
APPENDIX	41
COMERCIAL NETWORK	59

CONFIDENTIAL

All the information contained therein constitutes confidential information and is the sole property of TELEVES, S.A.U. or any company belonging to TELEVES CORPORATION (TELCOR, S.A.), being protected by intellectual property rights and trade secrets. Consequently, any communication, discussion and/or publication thereof is expressly forbidden, unless prior written authorisation by a TELEVES legal representative.

INTERURBAN OUTDOOR LIGHTING

- CIES
- ATMOSLED
- ACCESSORIES



CIES

**ECOLOGICAL LIGHTS MADE OF TECHNICAL POLYMER
INVULNERABLE EVERYWHERE**



REMOTE MANAGEMENT



CIES is the first series of luminaires manufactured in technical polymers specially formulated by Televes, combining design, mechanical and materials engineering and the latest electronic technology to satisfy the most demanding customers.

This series provides a breakthrough solution in the lighting market, perfect for the most aggressive environments and optimizes operation, installation and maintenance.





**ROAD AND
INTERURBAN**



MARITIME AREA

INTERURBAN OUTDOOR LIGHTING

CIES

REF.	LOGICAL REF.	No. LEDs		CONTROL	OPTIC TYPE	POWER (W)		EAN13
E-Series								
60060000300821	CI1230-T3WG39	12	3000K	No dimmable	T3	39	White/Grey	8424450243237
60060001300821	CI1230D-T3WG39	12	3000K	Dimmable	T3	39	White/Grey	8424450243800
60160000300821	CI2430-T3WG53	24	3000K	No dimmable	T3	53	White/Grey	8424450243527
60160001300821	CI2430D-T3WG53	24	3000K	Dimmable	T3	53	White/Grey	8424450244074
E4-Series								
60060200300821	CI41230-T3WG40	12	3000K	Programmable	T3	40	White/Grey	8424450240588
60160200300821	CI42430-T3WG70	24	3000K	Programmable	T3	70	White/Grey	8424450244814
T-Series								
★ 60060400300821	CIT1230-T3WG40	12	3000K	Programmable	T3	40	White/Grey	8424450292662
★ 60160400300821	CIT2430-T3WG70	24	3000K	Programmable	T3	70	White/Grey	8424450296066
N-Series								
60080000300821	CIN1230-T3WG39	12	3000K	Remote control	T3	39	White/Grey	8424450244340
60180000300821	CIN2430-T3WG53	24	3000K	Remote control	T3	53	White/Grey	8424450244616
★ 60180200300821	CIN2430-T3WG70	24	3000K	Remote control	T3	70	White/Grey	8424450293539
Z-Series								
60090200300821	CIZ1230-T3WG40	12	3000K	Remote control	T3	40	White/Grey	8424450258989
60190200300821	CIZ2430-T3WG70	24	3000K	Remote control	T3	70	White/Grey	8424450259160



Multiple configurable options are available:

- **Colour temperatures:** PC Amber, 2,200K, 2,700K, 3,000K, 4,000K
- **Types of optics** (light distribution in Appendix): P, T2, ME, T3, T4, APZ, SCL
- **Electrical class:** Class I and Class II, on request
- **CRI:** greater than 70, 80, 90
- **Finishes:** any colour from the RAL range

Price may vary depending on the option

ATMOSLED

**INTERURBAN ROAD LIGHTING
AND FOR VARIOUS OUTDOOR AREAS**



Highly versatile road luminaire adaptable to any outdoor environment, built in extruded anodised aluminium specially designed for perfect thermal management, optimised service life and resistance to aggressive environments.

Designed to increase energy savings and reduce maintenance costs thanks to its high efficiency and durability.



**ROAD AND
INTERURBAN**

INTERURBAN OUTDOOR LIGHTING

ATMOSLED

REF.	LOGICAL REF.	No. LEDs		CONTROL	OPTIC TYPE	POWER (W)		EAN13
E-Series								
68030000300801	AE1230-T3AL39	12	3000K	No dimmable	T3	39	Aluminum	8424450217023
68030001300801	AE1230D-T3AL39	12	3000K	Dimmable	T3	39	Aluminum	8424450216811
68130000300801	AE2430-T3AL58	24	3000K	No dimmable	T3	58	Aluminum	8424450219294
68130001300801	AE2430D-T3AL58	24	3000K	Dimmable	T3	58	Aluminum	8424450217207
68230000300801	AE3630-T3AL78	36	3000K	No dimmable	T3	78	Aluminum	8424450218228
68230001300801	AE3630D-T3AL78	36	3000K	Dimmable	T3	78	Aluminum	8424450231401
68330000300801	AE4830-T3AL108	48	3000K	No dimmable	T3	108	Aluminum	8424450218556
68330001300801	AE4830D-T3AL108	48	3000K	Dimmable	T3	108	Aluminum	8424450218716
★ 68530000300801	AE7230-T3AL165	72	3000K	No dimmable	T3	165	Aluminum	8424450231531
★ 68530001300801	AE7230D-T3AL165	72	3000K	Dimmable	T3	165	Aluminum	8424450231760
E4-Series								
68030200300801	AE41230-T3AL40	12	3000K	Programmable	T3	40	Aluminum	8424450241578
68130200300801	AE42430-T3AL60	24	3000K	Programmable	T3	60	Aluminum	8424450241387
68230200300801	AE43630-T3AL77	36	3000K	Programmable	T3	77	Aluminum	8424450241714
68330200300801	AE44830-T3AL109	48	3000K	Programmable	T3	109	Aluminum	8424450242056
68530200300801	AE47230-T3AL148	72	3000K	Programmable	T3	148	Aluminum	8424450253915
N-Series								
68050000300801	AN1230-T3AL39	12	3000K	Remote control	T3	39	Aluminum	8424450232132
68150000300801	AN2430-T3AL58	24	3000K	Remote control	T3	58	Aluminum	8424450234730
68250000300801	AN3630-T3AL78	36	3000K	Remote control	T3	78	Aluminum	8424450234488
68350000300801	AN4830-T3AL108	48	3000K	Remote control	T3	108	Aluminum	8424450233115
★ 68550000300801	AN7230-T3AL165	72	3000K	Remote control	T3	165	Aluminum	8424450224489
Z-Series								
68090200300801	AZ1230-T3AL40	12	3000K	Remote control	T3	40	Aluminum	8424450220191
68190200300801	AZ2430-T3AL60	24	3000K	Remote control	T3	60	Aluminum	8424450220412
68290200300801	AZ3630-T3AL77	36	3000K	Remote control	T3	77	Aluminum	8424450220641
68390200300801	AZ4830-T3AL109	48	3000K	Remote control	T3	109	Aluminum	8424450220870
68590200300801	AZ7230-T3AL148	72	3000K	Remote control	T3	148	Aluminum	8424450254189



Multiple configurable options are available:

- Colour temperatures: PC Amber, 2,200K, 2,700K, 3,000K, 4,000K
- Types of optics (light distribution in Appendix): P, T2, ME, T3, T4, APZ, SCL
- CRI: greater than 70, 80, 90
- Finishes: any colour from the RAL range

Price may vary depending on the option

ACCESSORIES

REF.	LOGICAL REF.	DESCRIPTION	EAN13
69000201	ASH8AL	Horizontal Arm Support for AtmosLED, Aluminium	8424450191880
69000401	ASV8AL	Vertical Arm Support for AtmosLED, Aluminium	8424450191903
69000601	ASD8AL	Double Arm Support for AtmosLED, Aluminium	8424450199787
69000801	ASW8AL	Wall Support for AtmosLED, Galvanized Steel	8424450199817
690010	AP40	Pole Adapter Ø30-40mm for CIES and AtmosLED	8424450231913
690011	ATAP76	Pole Adapter Ø76mm for AtmosLED	8424450231920
690012	AAP42	Pole Adapter Ø42mm for CIES and AtmosLED	8424450261262
★ 690013	AP76	Pole Adapter Ø76mm for CIES and AtmosLED	8424450271957
690020	ASW	Wall Support for CIES	8424450251355
★ 690021	SHV-76	Horizontal/Vertical Column Support Ø76mm for CIES	8424450282021
690604	POLE4AL	Fiberglass Column for CIES and AtmosLED. 4m	8424450251812
690605	POLE5AL	Fiberglass Column for CIES and AtmosLED. 5m	8424450251829
690606	POLE6AL	Fiberglass Column for CIES and AtmosLED. 6m	8424450251836
690607	POLE7AL	Fiberglass Column for CIES and AtmosLED. 7m	8424450251843
690608	POLE8AL	Fiberglass Column for CIES and AtmosLED. 8m	8424450251850
690609	POLE9AL	Fiberglass Column for CIES and AtmosLED. 9m	8424450251867
691001	ANC	NEMA connector cap for AtmosLED N-Series	8424450206263
★ 692101	SPIP66	Surge Protection device Class II. IP66	8424450271711



▲ 69000601



▲ 69000801



▼ 690020



▼ 692101

URBAN AND RESIDENTIAL OUTDOOR LIGHTING

- URBAN ALAMEDA
- URBAN MAIA
- VILLA LAMP
- FERNANDINA LAMP
- AROUSA LAMP
- ACCESSORIES

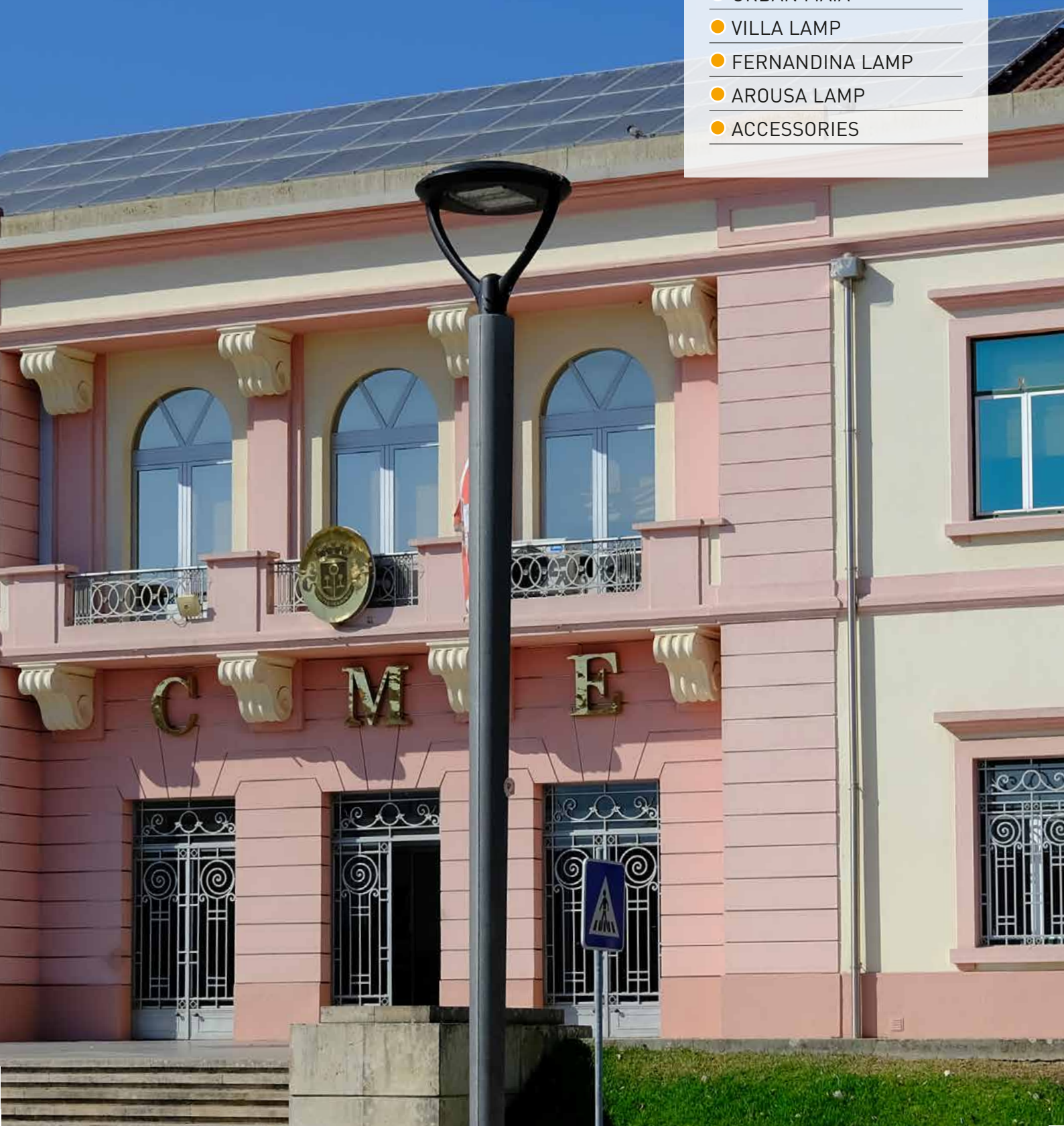

URBAN

ALAMEDA | MAIA

LUMINAIRES WITH A FRESH STYLE TO ENHANCE LIGHTING
IN THE HEART OF CITIES



Decorative urban luminaire made of die-cast aluminium. The Urban series has a compact design with smooth geometric lines, which integrates harmoniously with the environment, making it perfect for urban and residential spaces.



It stands out for its easy installation and maintenance without the need of tools. In addition, its high-quality tempered glass protector favours visual comfort and reduces glare.





URBAN AND
RESIDENTIAL

URBAN AND RESIDENTIAL OUTDOOR LIGHTING

URBAN ALAMEDA

REF.	LOGICAL REF.	No. LEDs		CONTROL	OPTIC TYPE	POWER (W)		EAN13
E-Series								
63170300301102	UA2430-D90BL53	24	3000K	No dimmable	D90	53	Black	8424450230237
63170301301102	UA2430D-D90BL53	24	3000K	Dimmable	D90	53	Black	8424450230190
63171300301102	UA2430-D90BL39	24	3000K	No dimmable	D90	39	Black	8424450219539
63171301301102	UA2430D-D90BL39	24	3000K	Dimmable	D90	39	Black	8424450230145
E4-Series								
66170300301102	UA42430-D90BL60	24	3000K	Programmable	D90	60	Black	8424450243008
66171300301102	UA42430-D90BL40	24	3000K	Programmable	D90	40	Black	8424450242926
N-Series								
★ 63180300301102	UAN2430-D90BL53	24	3000K	Remote control	D90	53	Black	8424450299005
★ 63181300301102	UAN2430-D90BL39	24	3000K	Remote control	D90	39	Black	8424450300008
Z-Series								
66190300301102	UAZ2430-D90BL60	24	3000K	Remote control	D90	60	Black	8424450221686
66191300301102	UAZ2430-D90BL40	24	3000K	Remote control	D90	40	Black	8424450221631

URBAN MAIA

REF.	LOGICAL REF.	No. LEDs		CONTROL	OPTIC TYPE	POWER (W)		EAN13
E-Series								
63071400300102	UM1230-PBL39	12	3000K	No dimmable	P	39	Black	8424450230275
63071401300102	UM1230D-PBL39	12	3000K	Dimmable	P	39	Black	8424450222171
63170400300102	UM2430-PBL53	24	3000K	No dimmable	P	53	Black	8424450230527
63170401300102	UM2430D-PBL53	24	3000K	Dimmable	P	53	Black	8424450222409
E4-Series								
66071400300102	UM41230-PBL40	12	3000K	Programmable	P	40	Black	8424450242339
66170400300102	UM42430-PBL75	24	3000K	Programmable	P	75	Black	8424450242698
N-Series								
★ 63081400300102	UMN1230-PBL39	12	3000K	Remote control	P	39	Black	8424450298985
★ 63180400300102	UMN2430-PBL53	24	3000K	Remote control	P	53	Black	8424450299012
Z-Series								
66091400300102	UMZ1230-PBL40	12	3000K	Remote control	P	40	Black	8424450221488
66190400300102	UMZ2430-PBL75	24	3000K	Remote control	P	75	Black	8424450221778



Multiple configurable options are available:

- Colour temperatures: PC Amber, 2,200K, 2,700K, 3,000K, 4,000K
- Types of optics (light distribution in Appendix):
 - ALAMEDA: SP, D90, T3-B90, T2-C90
 - MAIA: P, T2, ME, T3, T4, APZ, SCL, PX, PXL
- Electrical class: Class I and Class II, on request
- CRI: greater than 70, 80, 90
- Finishes: any colour from the RAL range

Price may vary depending on the option

LAMP

VILLA | FERNANDINA

CLASSIC LUMINAIRES WITH GREAT HISTORICAL AND DECORATIVE VALUE
USING THE MOST MODERN LED TECHNOLOGY



Luminaires of great decorative and artistic value, combining a classic and traditional line with the most advanced and efficient LED technology.



Its design offers the opportunity to preserve the historical heritage, while obtaining a better lighting, responsible and adapted to the environment. Easy to install and maintain, it is ideal for historic and urban spaces as well as residential streets, squares or parks.



ORNAMENTAL

URBAN AND RESIDENTIAL OUTDOOR LIGHTING

ORNAMENTAL LAMPS

REF.	LOGICAL REF.	No. LEDs		CONTROL	OPTIC TYPE	POWER (W)		EAN13
Villa style								
E-Series								
63070100300102	VI1230-PBL29	12	3000K	No dimmable	P	29	Black	8424450201640
63070101300102	VI1230D-PBL29	12	3000K	Dimmable	P	29	Black	8424450232934
63071100300102	VI1230-PBL39	12	3000K	No dimmable	P	39	Black	8424450232699
63071101300102	VI1230D-PBL39	12	3000K	Dimmable	P	39	Black	8424450236543
63170100300102	VI2430-PBL53	24	3000K	No dimmable	P	53	Black	8424450201657
63170101300102	VI2430D-PBL53	24	3000K	Dimmable	P	53	Black	8424450214572
E4-Series								
★ 63074100300102	VI41230-PBL40	12	3000K	Programmable	P	40	Black	8424450304587
★ 63174100300102	VI42430-PBL60	24	3000K	Programmable	P	60	Black	8424450304594
Fernandina style								
E-Series								
63070200300102	FE1230-PBL29	12	3000K	No dimmable	P	29	Black	8424450201763
63070201300102	FE1230D-PBL29	12	3000K	Dimmable	P	29	Black	8424450208595
63071200300102	FE1230-PBL39	12	3000K	No dimmable	P	39	Black	8424450247419
63071201300102	FE1230D-PBL39	12	3000K	Dimmable	P	39	Black	8424450247716
63170200300102	FE2430-PBL53	24	3000K	No dimmable	P	53	Black	8424450249963
63170201300102	FE2430D-PBL53	24	3000K	Dimmable	P	53	Black	8424450214589
E4-Series								
★ 63074200300102	FE41230-PBL40	12	3000K	Programmable	P	40	Black	8424450304624
★ 63174200300102	FE42430-PBL60	24	3000K	Programmable	P	60	Black	8424450304631

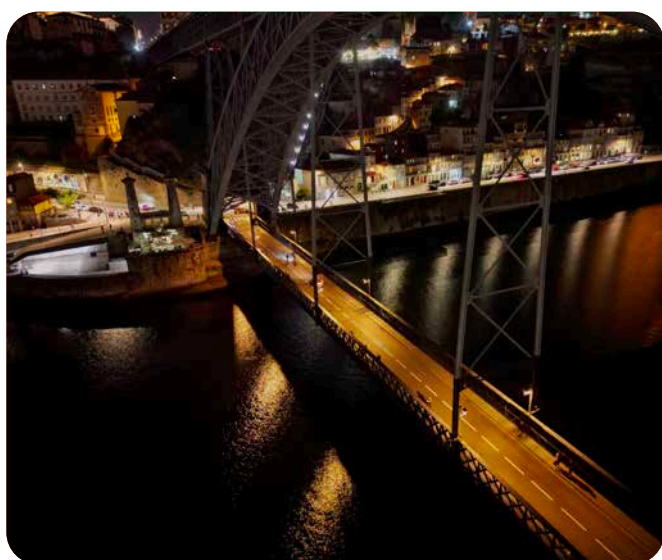

Multiple configurable options are available:

- Colour temperatures: PC Amber, 2,200K, 2,700K, 3,000K, 4,000K
- Types of optics (light distribution in Appendix): P, SP, T2, ME, T3, T4, APZ, SCL
- CRI: greater than 70, 80, 90
- Finishes: any colour from the RAL range

Price may vary depending on the option

AROUSA LAMP

VANDAL-RESISTANT STAINLESS STEEL LAMPS FOR PEDESTRIAN AREAS AND GARDENS

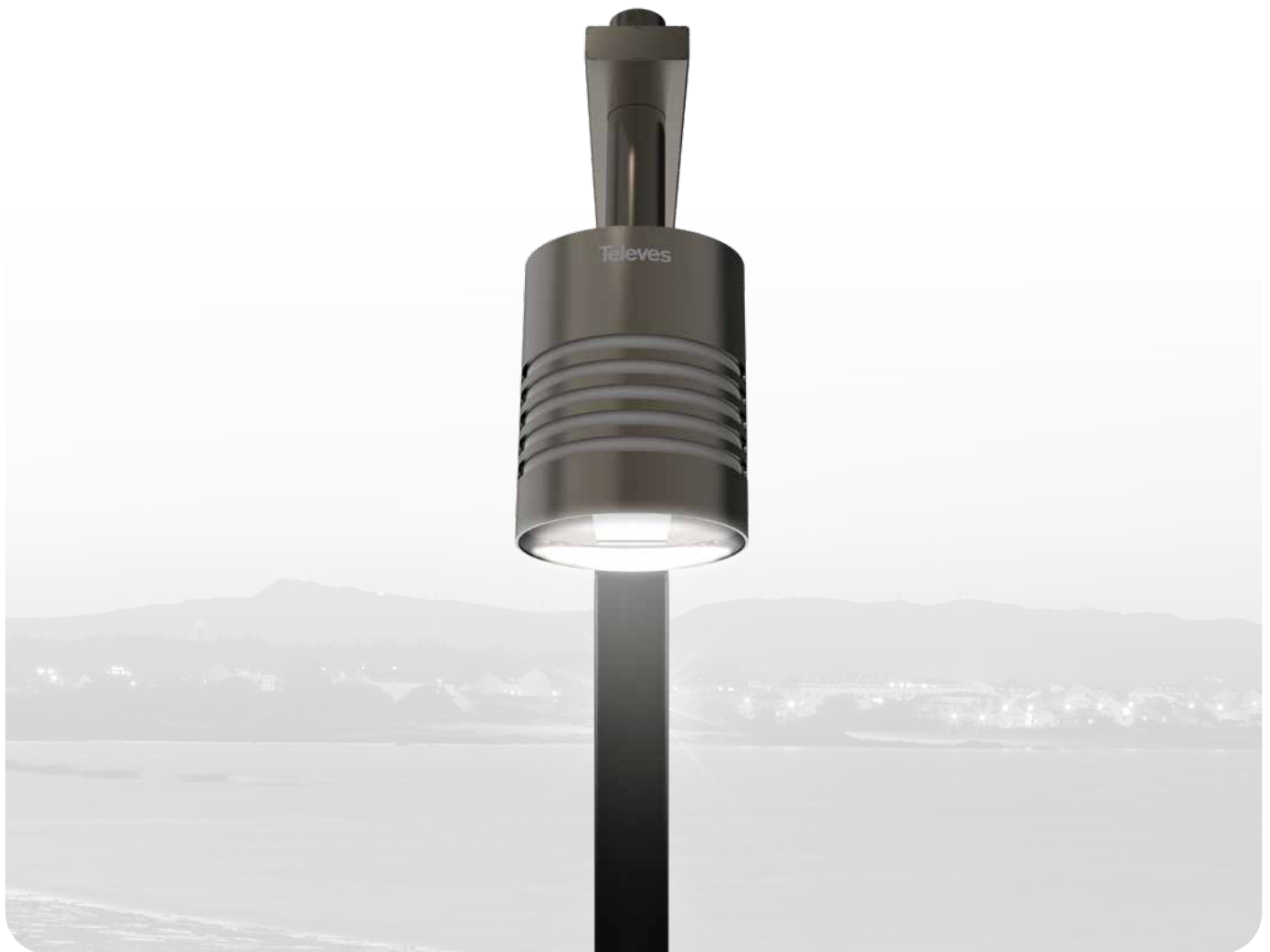

The Arousa lamp features an integrated functionality and style, thanks to its highly durable modern design and its wide scope of illumination, when installed on columns or on a wall. Its stainless steel structure stands out for its ability to remain unalterable against vandalism and its resistance to adverse weather conditions, even in maritime environments.

Arousa aesthetic line combines lamps and bollards to illuminate parks or paths in a balanced and harmonious way.





MARITIME AREA



PATHS

URBAN AND RESIDENTIAL OUTDOOR LIGHTING

AROUSAL LAMPS

REF.	LOGICAL REF.	No. LEDs		CONTROL	OPTIC TYPE	POWER (W)		EAN13
★ 63030000300805	AL1230-T3XM39	12	3000K	No dimmable	T3	39	Inox	8424450270172
★ 63030001300805	AL1230D-T3XM39	12	3000K	Dimmable	T3	39	Inox	8424450270134

Multiple configurable options are available:

- **Colour temperatures:** PC Amber, 2,200K, 2,700K, 3,000K, 4,000K
- **Types of optics** (light distribution in Appendix): P, SP, T2, ME, T3, T4, APZ, SCL
- **CRI:** greater than 70, 80, 90
- **Finishes:** any colour from the RAL range

Price may vary depending on the option

ACCESSORIES

REF.	LOGICAL REF.	DESCRIPTION	EAN13
★ 690014	AP76BL	Pole Adapter Ø76mm for Maia	8424450304662
690401	VA60	Column Adapter Ø60mm and Ø76mm for Lamp	8424450208502
690409	VD-4	Frosted diffuser for Villa Lamp. UV resistant polycarbonate (4 pcs.)	8424450252000
690410	AA60	Column Adapter Ø60mm for Alameda	8424450237922
690420	MA42	Column Adapter Ø42mm for Maia	8424450252239
★ 69050105	ALWS	Wall Support for Arousa Lamp	8424450272992
★ 69050205	ALP6	Column for Arousa Lamp. 6m	8424450278154
★ 692101	SPIP66	Surge Protection device Class II. IP66	8424450271711



69050205



69050105



690410



690401



690409

ROAD SAFETY LIGHTING

- CIES CROSSWALK
- MOTION SENSORS
- ACCESSORIES

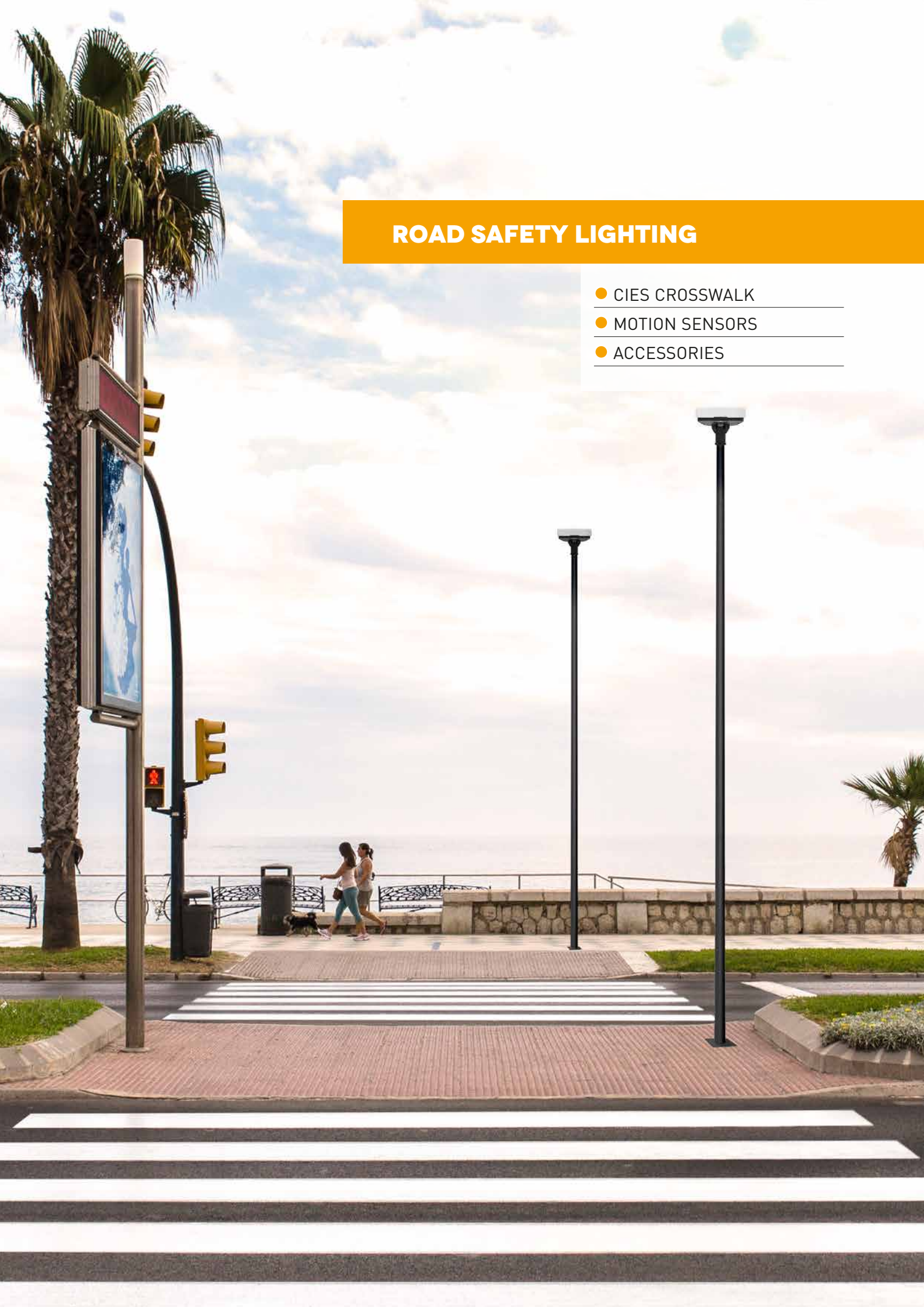

CIES CROSSWALK

SMART LIGHTING FOR THE BENEFIT OF PUBLIC SECURITY



CIES Crosswalk is a smart LED lighting solution designed to improve safety at crosswalks or lightly frequented paths and trails. The luminaire uses a motion sensor to increase the illumination of the crossing area when it detects a pedestrian, thus reducing the risk of accidents and improving road safety. This presence detection makes it possible to regulate the lighting level by increasing it to the maximum when it detects passers-by and reducing it when there are no passers-by. This optimizes savings and minimizes light pollution without compromising pedestrian safety.

It also contributes to public safety if installed on streets or footpaths that are normally less frequented at night. The lighting increases detection by the pedestrian, who gains greater visibility and can more easily identify potential hazards or obstacles, improving his or her sense of security. In addition, this improved visibility acts as a deterrent to criminals, reducing the likelihood of assault or robbery.

Thanks to smart lighting, an appropriate balance between energy efficiency, public safety and environmental protection is achieved.



PATHS



ROAD SAFETY

ROAD SAFETY LIGHTING

CIES CROSSWALK

REF.	LOGICAL REF.	No. LEDs		CONTROL	OPTIC TYPE	POWER (W)		EAN13
★ 60099200401222	CIXZ1240-PXWB40	12	4000K	Programmable	PX	40	White/Black	8424450298763
★ 60199200401222	CIXZ2440-PXWB70	24	4000K	Programmable	PX	70	White/Black	8424450298794

MOTION SENSORS

REF.	LOGICAL REF.	DESCRIPTION	EAN13
★ 693021	SP360CIX	Motion and Light Sensor 180° for CIES Crosswalk	8424450278123
★ 693022	SP180CIX	Motion and Light Sensor 360° for CIES Crosswalk	8424450278130

ACCESSORIES

REF.	LOGICAL REF.	DESCRIPTION	EAN13
690010	AP40	Pole Adapter Ø30-40mm for CIES and AtmosLED	8424450231913
690012	AAP42	Pole Adapter Ø42mm for CIES and AtmosLED	8424450261262
★ 690013	AP76	Pole Adapter Ø76mm for CIES and AtmosLED	8424450271957
690020	ASW	Wall Support for CIES	8424450251355
★ 690021	SHV-76	Horizontal/Vertical Column Support Ø76mm for CIES	8424450282021
690604	POLE4AL	Fiberglass Column for CIES and AtmosLED. 4m	8424450251812
690605	POLE5AL	Fiberglass Column for CIES and AtmosLED. 5m	8424450251829
690606	POLE6AL	Fiberglass Column for CIES and AtmosLED. 6m	8424450251836
690607	POLE7AL	Fiberglass Column for CIES and AtmosLED. 7m	8424450251843
690608	POLE8AL	Fiberglass Column for CIES and AtmosLED. 8m	8424450251850
690609	POLE9AL	Fiberglass Column for CIES and AtmosLED. 9m	8424450251867



▲ 693022



Multiple configurable options are available:

- **Colour temperatures:** 3,000K, 4,000K, 5,000K, 5,700K
- **Types of optics** (light distribution in Appendix): PX, PXL, T3
- **CRI:** greater than 70, 80, 90
- **Finishes:** any colour from the RAL range

Price may vary depending on the option



▲ 690013



▲ 690012



▲ 690021

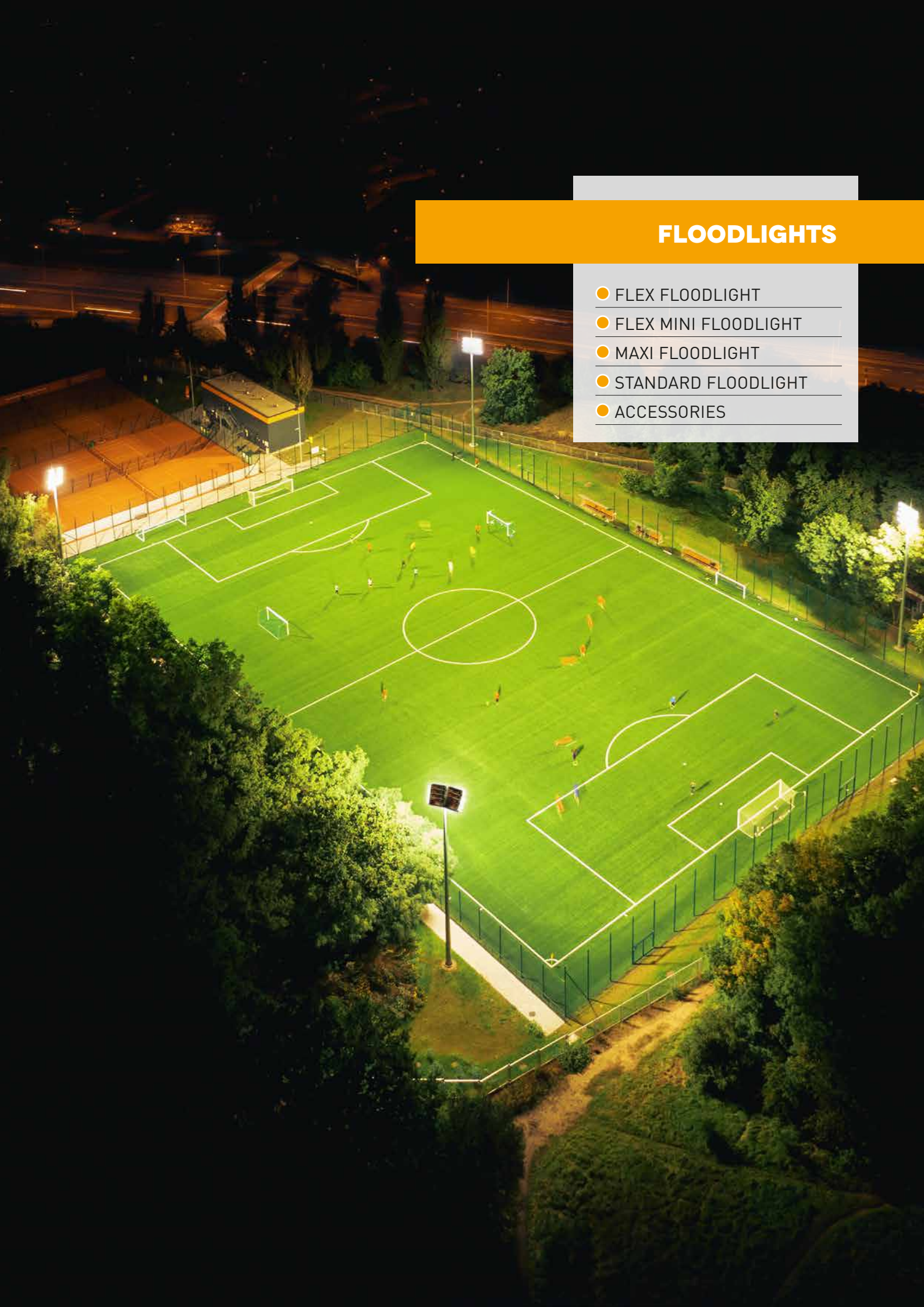

FLOODLIGHTS

- FLEX FLOODLIGHT
- FLEX MINI FLOODLIGHT
- MAXI FLOODLIGHT
- STANDARD FLOODLIGHT
- ACCESSORIES

FLEX FLOODLIGHT

HIGH-POWER MODULAR LIGHTING FOR PROFESSIONAL SPORTS FACILITIES AND LARGE AREAS



Flex floodlights combine excellent performance and high power in a practical modular format, up to 4 modules per bracket, optimizing resources. Thanks to their high efficiency, durability and ease of maintenance, excellent cost-effectiveness is achieved.

Its scalable design, from 1 to 4 modules on a single support and the different configurations per module (power, optics and number of LEDs), offer a range from 250 to 1200 W. A wide range of possibilities that makes Flex floodlights the right choice for any space.



SPORTS AREAS





SPECIAL FACILITIES



FLOODLIGHTS

SPORT OR LARGE AREAS

REF.	LOGICAL REF.	No. LEDs		CONTROL	OPTIC TYPE	POWER (W)		EAN13
Flex floodlight								
E-Series								
67110000401601	FF9640-S40AL250	96	4000K	No dimmable	S40	250	Aluminum	8424450266403
67110100401601	FF9640-S40AL300	96	4000K	No dimmable	S40	300	Aluminum	8424450266588
67110200401601	FF19240-S40AL500	192	4000K	No dimmable	S40	500	Aluminum	8424450268216
67110300401601	FF19240-S40AL600	192	4000K	No dimmable	S40	600	Aluminum	8424450268391
67110400401601	FF28840-S40AL750	288	4000K	No dimmable	S40	750	Aluminum	8424450268575
67110500401601	FF28840-S40AL900	288	4000K	No dimmable	S40	900	Aluminum	8424450268759
67110600401601	FF38440-S40AL1000	384	4000K	No dimmable	S40	1000	Aluminum	8424450268933
67110700401601	FF38440-S40AL1200	384	4000K	No dimmable	S40	1200	Aluminum	8424450269114
E4-Series								
★ 67112000401601	FF49640-S40AL250	96	4000K	Programmable	S40	250	Aluminum	8424450274538
★ 67112100401601	FF49640-S40AL300	96	4000K	Programmable	S40	300	Aluminum	8424450274637
★ 67112200401601	FF419240-S40AL500	192	4000K	Programmable	S40	500	Aluminum	8424450274897
★ 67112300401601	FF419240-S40AL600	192	4000K	Programmable	S40	600	Aluminum	8424450275016
★ 67112400401601	FF428840-S40AL750	288	4000K	Programmable	S40	750	Aluminum	8424450275214
★ 67112500401601	FF428840-S40AL900	288	4000K	Programmable	S40	900	Aluminum	8424450275337
★ 67112600401601	FF438440-S40AL1000	384	4000K	Programmable	S40	1000	Aluminum	8424450275450
★ 67112700401601	FF438440-S40AL1200	384	4000K	Programmable	S40	1200	Aluminum	8424450275573
R-Series								
★ 67120000401601	FFR9640-S40AL250	96	4000K	Remote control	S40	250	Aluminum	8424450275627
★ 67120100401601	FFR9640-S40AL300	96	4000K	Remote control	S40	300	Aluminum	8424450275696
★ 67120200401601	FFR19240-S40AL500	192	4000K	Remote control	S40	500	Aluminum	8424450275702
★ 67120300401601	FFR19240-S40AL600	192	4000K	Remote control	S40	600	Aluminum	8424450275719
★ 67120400401601	FFR28840-S40AL750	288	4000K	Remote control	S40	750	Aluminum	8424450286968
★ 67120500401601	FFR28840-S40AL900	288	4000K	Remote control	S40	900	Aluminum	8424450275726
★ 67120600401601	FFR38440-S40AL1000	384	4000K	Remote control	S40	1000	Aluminum	8424450297377
★ 67120700401601	FFR38440-S40AL1200	384	4000K	Remote control	S40	1200	Aluminum	8424450275733



Multiple configurable options are available:

- **Colour temperatures:** 2,200K, 3,000K, 4,000K, 5,000K, 5,700K
- **Types of optics** (light distribution in Appendix): S20, S40, S60, S90, AF1
- **CRI:** greater than 70, 80, 90
- **Finishes:** any colour from the RAL range

Price may vary depending on the option



FLEX MINI FLOODLIGHT

HIGHLY EFFICIENT LIGHTING IN COMPACT DIMENSIONS



Flex Mini Floodlights offer high efficiency and excellent lighting performance in a compact and easy-to-install format. Its self-installable structure does not require any additional support. In addition, the inclination of the base and the adjustment of the angle of rotation of the floodlight allow the lighting to be directed precisely towards the area of interest, without glare or shadows.

The design of the Flex Mini Floodlights optimizes space without compromising on light power. They are ideal for smaller sports facilities that also require high levels of illumination, such as paddle and tennis courts or basketball courts.



SPORTS AREAS



TUNNELS

SPORT OR LARGE AREAS

REF.	LOGICAL REF.	No. LEDs		CONTROL	OPTIC TYPE	POWER (W)		EAN13
67910000980401	FFM9098-S60AL200	90	5000K	No dimmable	S60	200	Aluminum	8424450284025

Flex Mini floodlight



Multiple configurable options are available:

- **Colour temperatures:** 4,000K, 5,000K
- **Types of optics** (light distribution in Appendix): S60, S90, S120, T2M
- **CRI:** greater than 80, 90
- **Finishes:** any colour from the RAL range

Price may vary depending on the option

MAXI FLOODLIGHTS

LIGHTING FOR SPORTS FACILITIES AND LARGE AREAS



Floodlights are high performance luminaires with high power. They have the ability to direct the luminous flux at a specific angle with great precision, exposing only the area of interest to the illumination provided.

Maxi Floodlights are specially designed to illuminate large sports surfaces, perfectly meeting the visual requirements necessary for sports practice, even for top-level competitions.



SPORTS AREAS

SPORT OR LARGE AREAS

REF.	LOGICAL REF.	No. LEDs		CONTROL	OPTIC TYPE	POWER (W)		EAN13
Maxi floodlight								
67310000300301	FM4830-S90AL150	48	3000K	No dimmable	S90	150	Aluminum	8424450209653
67510000300301	FM7230-S90AL196	72	3000K	No dimmable	S90	196	Aluminum	8424450209660



Multiple configurable options are available:

- **Colour temperatures:** PC Amber, 2,200K, 3,000K, 4,000K, 5,000K, 5,700K
- **Types of optics** (light distribution in Appendix): S90, S30, S60, APZ
- **CRI:** greater than 70, 80, 90
- **Finishes:** any colour from the RAL range

Price may vary depending on the option

STANDARD FLOODLIGHT

ILLUMINATION THAT ENHANCES THE BEAUTY OF CITIES THROUGH LIGHT



Standard Floodlights are the perfect solution for ornamental, artistic or monumental lighting, where light acquires a highly aesthetic value. Their objective is to enhance the beauty of the objects to attract the public's attention, treating lighting as an art, through the correct management of lights, shadows, contrasts and colors.

The Standard Floodlight combines its small size with great lighting performance, subtly blending into different landscapes and emphasizing objects of interest through an intensive beam of light of high quality and high efficiency.



ORNAMENTAL

ARCHITECTURAL AND ARTISTIC FLOODLIGHTING

REF.	LOGICAL REF.	No. LEDs		CONTROL	OPTIC TYPE	POWER (W)		EAN13
Standard floodlight								
6710000400301	FL2440-S90AL58	24	4000K	No dimmable	S90	58	Aluminum	8424450216491
67100001400301	FL2440D-S90AL58	24	4000K	Dimmable	S90	58	Aluminum	8424450216415
6730000400301	FL4840-S90AL108	48	4000K	No dimmable	S90	108	Aluminum	8424450216620
67300001400301	FL4840D-S90AL108	48	4000K	Dimmable	S90	108	Aluminum	8424450216545



Multiple configurable options are available:

- **Colour temperatures:** PC Amber, 2,200K, 2,700K, 3,000K, 4,000K, 5,000K, 5,700K
- **Types of optics** (light distribution in Appendix): S90, S30, S60, APZ
- **CRI:** greater than 70, 80, 90
- **Finishes:** any colour from the RAL range

Price may vary depending on the option

FLOODLIGHTS

ACCESSORIES

REF.	LOGICAL REF.	DESCRIPTION	EAN13
690101	ISE	Embedded Support for Maxi Floodlight and InnerLED, Galvanized Steel	8424450191958
69030101	MFWS48AL	Wall Support for 48LED Maxi Floodlight and InnerLED, Lacquered Steel	8424450205587
69030201	MFWS72AL	Wall Support for 72LED Maxi Floodlight and InnerLED, Lacquered Steel	8424450205594
69030301	MFCS48AL	Cross Support for 48LED Maxi Floodlight, Lacquered Steel	8424450205600
69030401	MFCS72AL	Cross Support for 72LED Maxi Floodlight, Lacquered Steel	8424450205617
690306	T360S4MF72G	360 Tower Support HDG for 4 Maxi/Flex Mini Floodlights or 2 Flex Floodlights	8424450255742
690307	T450S4MF72G	450 Tower Support HDG for 4 Maxi/Flex Mini Floodlights or 2 Flex Floodlights	8424450255759
690308	T450S6MF72G	450 Tower Support HDG for 6 Maxi/Flex Mini Floodlights or 3 Flex Floodlights	8424450255766
★ 690310	FFMC	Top Visor for Flex Floodlights	8424450295335
★ 690321	FFH1	Ceiling Mounting Kit for Flex Floodlights 1 Module	8424450271896
★ 690322	FFH2	Ceiling Mounting Kit for Flex Floodlights 2 Modules	8424450271902
★ 692101	SPIP66	Surge Protection device Class II. IP66	8424450271711
★ 692102	SPDC1	Surge protection device Class I. IP67	8424450278093



▲ 690101
69030101
69030201



▲ 69030301
69030401



▲ 692102



▲ 690308

BOLLARDS

- AROUSA
- ACCESSORIES

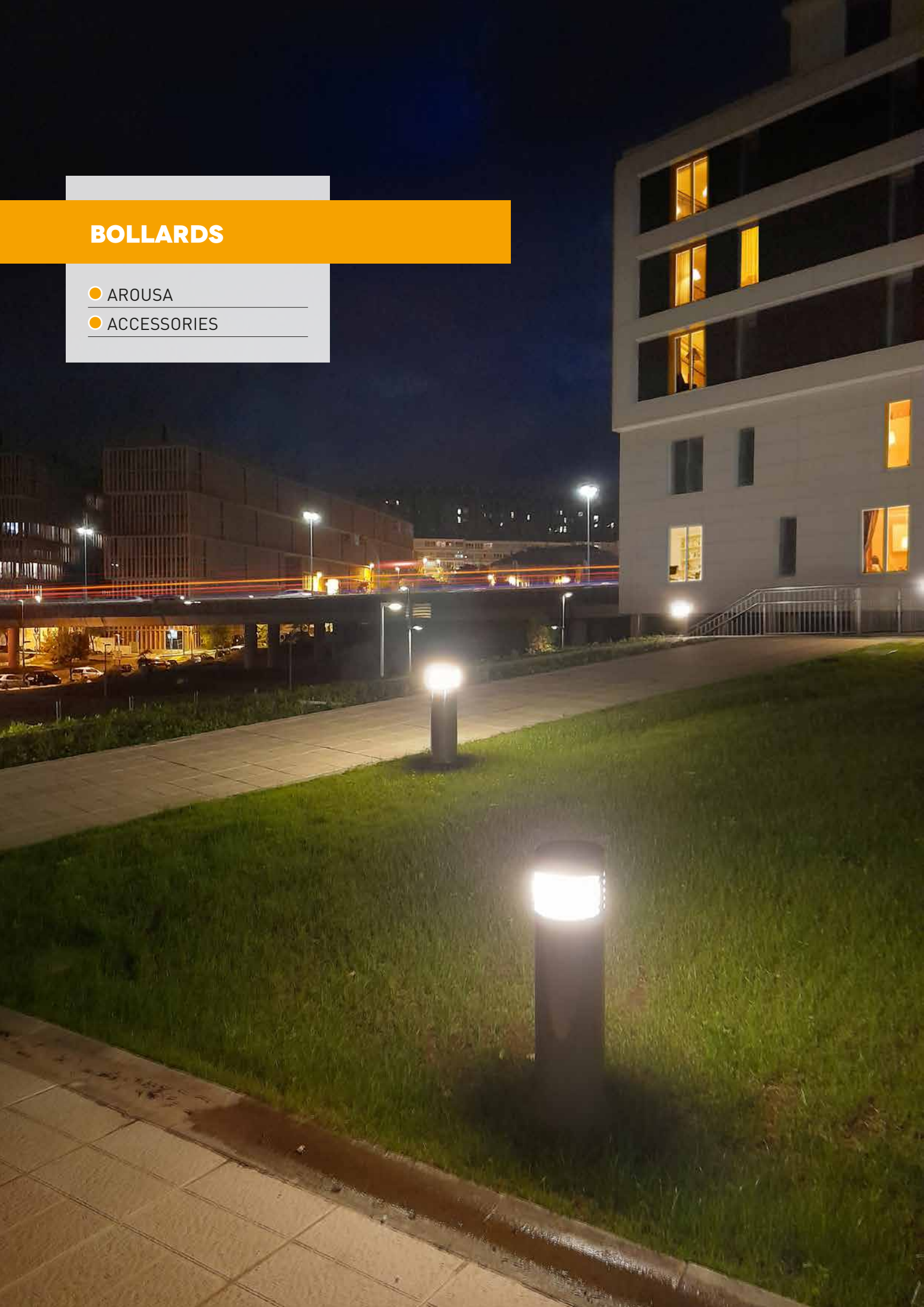

AROUSA

RUST-PROOF, VANDAL-PROOF PEDESTAL LIGHTS FOR PEDESTRIAN AND GARDEN AREAS



The Arousa pedestal light stands out for its high resistance and ability to remain unaltered in any environment, thanks to its high protection against impacts and its colorless anti-graffiti varnish coating. In addition, its high tightness and its stainless steel body also prevent the entry of water and oxidation. Arousa is a highly durable pedestal light, customizable in different aspects, such as performance, color and finish.



MARITIME AREA



PATHS

The range consists of two models of different heights: S (30 cm) and L (80 cm).

Arousa aesthetic line combines lamps and bollards to illuminate parks or paths in a balanced and harmonious way.

AROUSA

REF.	LOGICAL REF.	No. LEDs		CONTROL	OPTIC TYPE	POWER (W)		EAN13
Large model (L)								
70001000300205	ABL1230-SPXM24	12	3000K	No dimmable	SP	24	Inox	8424450229125
Small model (S)								
70000000300205	ABS1230-SPXM15	12	3000K	No dimmable	SP	15	Inox	8424450229378

ACCESSORIES

REF.	LOGICAL REF.	DESCRIPTION	EAN13
★ 692101	SPIP66	Surge Protection device Class II. IP66	8424450271711



Multiple configurable options are available:

- **Colour temperatures:** PC Amber, 2,200K, 2,700K, 3,000K, 4,000K
- **CRI:** greater than 70, 80, 90
- **Finishes:** any colour from the RAL range

Price may vary depending on the option

INDUSTRIAL INDOOR LIGHTING

- INNERLED
- ZAR HIGH-BAY LAMP
- ACCESSORIES



INNERLED

LINEAR LUMINAIRE FOR RECTANGULAR ROOMS IN INDUSTRIAL AND PROFESSIONAL ENVIRONMENTS



High-performance, high-quality LED luminaire for indoor use. Made from extruded and anodised aluminium that increases its toughness, it is highly resistant to impact and corrosion, guaranteeing high durability.

The InnerLED structure favours thermal control of the driver and the LED module, making it suitable for intensive use without raising its temperature.

Thanks to its high efficiency and durability, InnerLED is an excellent solution for reducing energy consumption and maintenance costs, while offering impeccable lighting, creating more pleasant spaces with greater visual comfort.





INDUSTRIAL



SPORTS AREAS

INNERLED

REF.	LOGICAL REF.	No. LEDs		CONTROL	OPTIC TYPE	POWER (W)		EAN13
62350000400301	IN4840-S90AL80	48	4000K	No dimmable	S90	80	Aluminum	8424450200971
62550000400301	IN7240-S90AL130	72	4000K	No dimmable	S90	130	Aluminum	8424450200995
62750000400301	IN9640-S90AL200	96	4000K	No dimmable	S90	200	Aluminum	8424450201015



Multiple configurable options are available:

- Colour temperatures: 3,000K, 4,000K, 5,000K, 5,700K
- Types of optics (light distribution in Appendix): S30, S60, S90
- CRI: greater than 70, 80, 90
- Finishes: any colour from the RAL range

Price may vary depending on the option

ZAR

UFO HIGH-BAY FOR OPEN SPACES IN INDUSTRIAL AND PROFESSIONAL ENVIRONMENTS



Indoor LED luminaire made of die-cast aluminum specially designed for perfect thermal management, optimized service life and high efficiency.

In industrial and professional environments it is important to have appropriate lighting levels that contribute to work safety, visual comfort and productivity. ZAR high-bay is a luminaire with great capacity to illuminate large spaces that require correct lighting, reaching the most demanding light quality levels (CRI > 80).



INDUSTRIAL

ZAR HIGH-BAY LAMP

REF.	LOGICAL REF.	No. LEDs		CONTROL	OPTIC TYPE	POWER (W)		EAN13
6210000401402	ZA25240-S120BL150	252	4000K	No dimmable	S120	150	Black	8424450246245
62101000401402	ZA25240-S120BL200	252	4000K	No dimmable	S120	200	Black	8424450246306



Multiple configurable options are available:

- Colour temperatures: 4,000K, 5,000K
- Types of optics (light distribution in Appendix): S60, S90, S120
- CRI: greater than 70, 80, 90

Price may vary depending on the option

ACCESSORIES

REF.	LOGICAL REF.	DESCRIPTION	EAN13
690101	ISE	Embedded Support for Maxi Floodlight and InnerLED, Galvanized Steel	8424450191958
69030101	MFWS48AL	Wall Support for 48LED Maxi Floodlight and InnerLED, Lacquered Steel	8424450205587
69030201	MFWS72AL	Wall Support for 72LED Maxi Floodlight and InnerLED, Lacquered Steel	8424450205594
★ 692101	SPIP66	Surge Protection device Class II. IP66	8424450271711
★ 692102	SPDC1	Surge protection device Class I. IP67	8424450278093
★ 693001	SPLIN	Motion and Light Sensor for InnerLED	8424450253076
★ 693011	SPLZA	Motion and Light Sensor for ZAR High-bay lamp	8424450253083
★ 693090	RC SPL	Remote Control for InnerLED or ZAR Motion and Light Sensor	8424450282007



▲ 692102

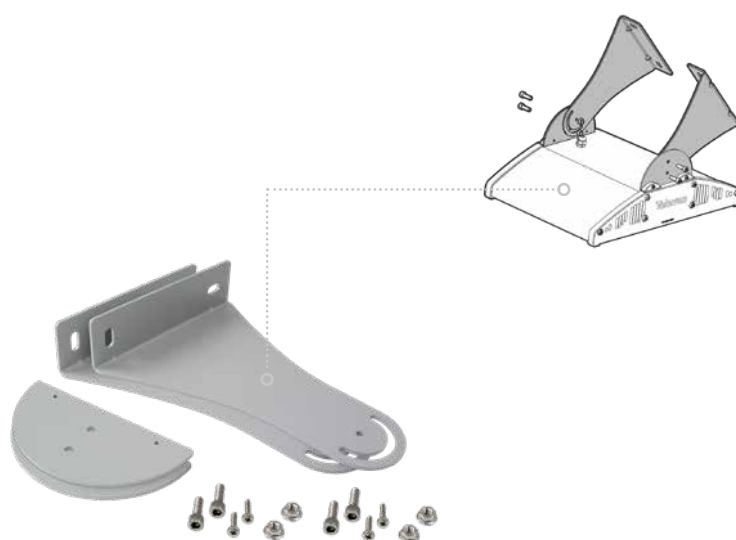

▲ 690101



▲ 693011

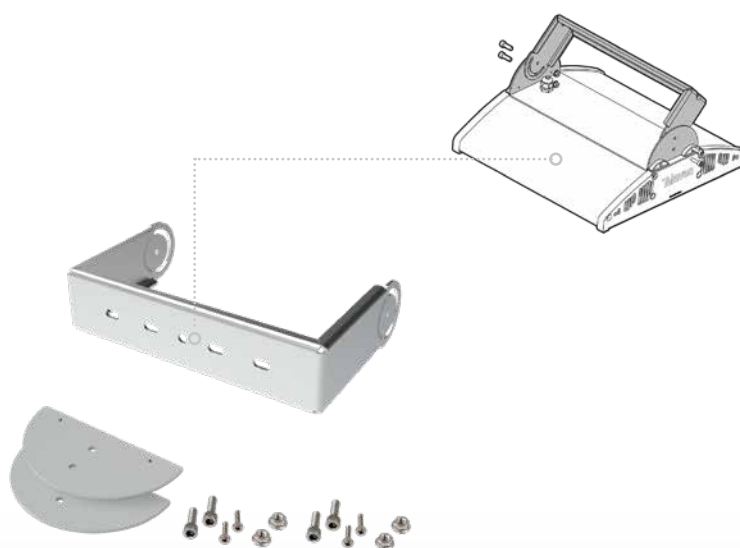

▲ 69030201

LIGHTING RENOVATION (RETROFIT)

- RETROFIT COMPONENT
- RETROFIT Q COMPONENT
- ACCESSORIES

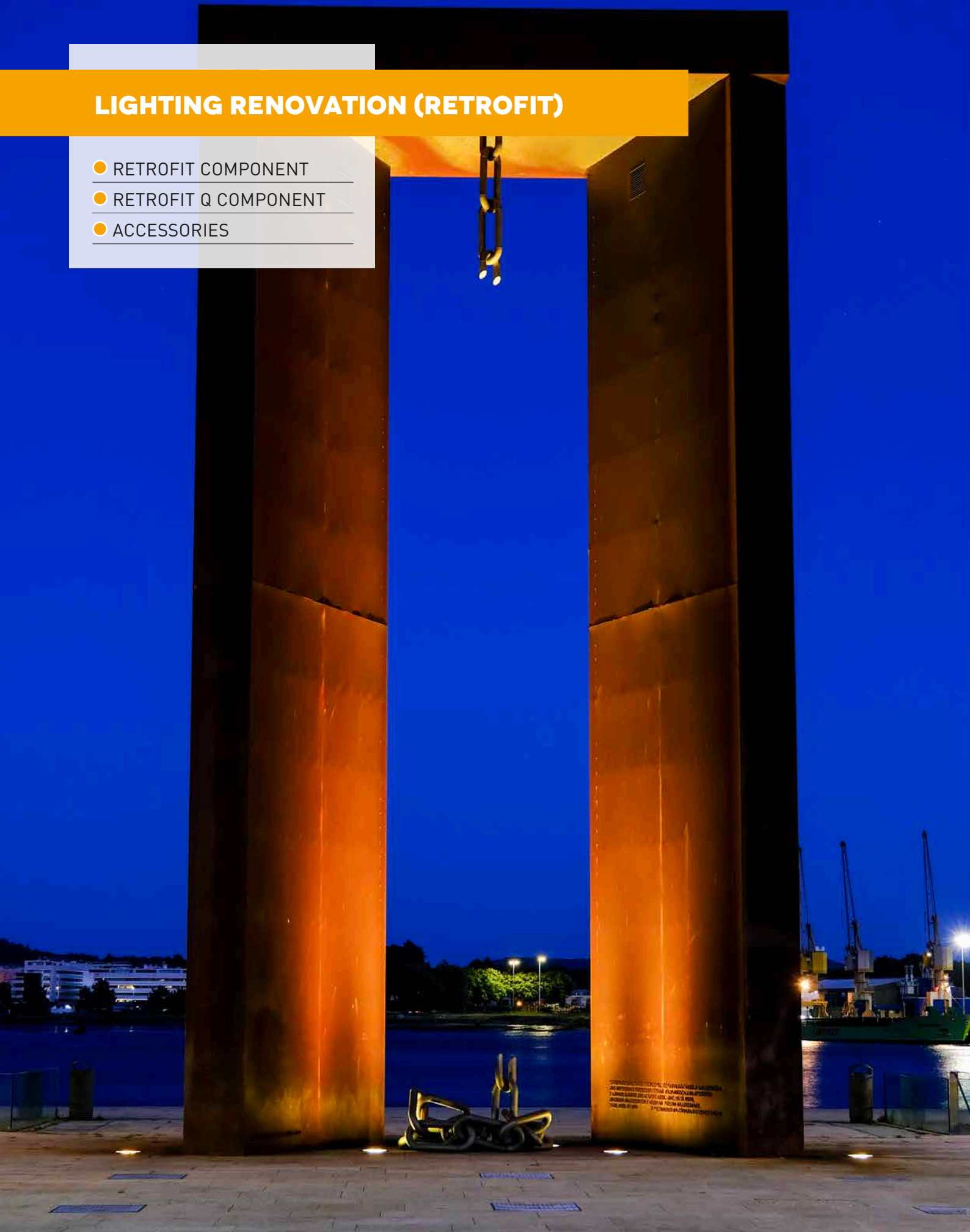

RETROFIT

RENOVATION TO LED TECHNOLOGY WHILE PRESERVING THE ORIGINAL STRUCTURE OF THE LUMINAIRE



Retrofit is the direct replacement of old lighting technologies with newer, more efficient ones, using the previous installations. It is the perfect lighting solution for sustainable consumption, high efficiency and high performance.

Retrofit is a safe bet in favour of ecology, as it prioritises the minimisation of waste generated by taking advantage of existing structures. It also stands out for the low consumption of LED technology and its great durability, offering responsible lighting by controlling the light emitted to the upper hemisphere of the luminaire.



LIGHTING RENOVATION



ORNAMENTAL



RETROFIT COMPONENT

REF.	LOGICAL REF.	No. LEDs		CONTROL	OPTIC TYPE	POWER (W)		EAN13
E-series								
63050000300101	RE1230-PBL29	12	3000K	No dimmable	P	29	Black	8424450200414
63050001300101	RE1230D-PBL29	12	3000K	Dimmable	P	29	Black	8424450200650
63051100300101	RE1230-PBL39	12	3000K	No dimmable	P	39	Black	8424450237960
63051101300101	RE1230D-PBL39	12	3000K	Dimmable	P	39	Black	8424450248218
63150000300101	RE2430-PBL53	24	3000K	No dimmable	P	53	Black	8424450200742
63150001300101	RE2430D-PBL53	24	3000K	Dimmable	P	53	Black	8424450200797
★ 63350000300102	RE4830-PAL106	48	3000K	No dimmable	P	106	Aluminum	8424450304679
★ 63550000300102	RE7230-PAL195	72	3000K	No dimmable	P	195	Aluminum	8424450304686
E4-Series								
★ 63059800300102	RE411230-PBL40	12	3000K	Programmable	P	40	Black	8424450304693
★ 63159800300102	RE412430-PBL60	24	3000K	Programmable	P	60	Black	8424450304709

RETROFIT Q COMPONENT

REF.	LOGICAL REF.	No. LEDs		CONTROL	OPTIC TYPE	POWER (W)		EAN13
E4-Series								
★ 63153100302302	REQ42430-AS1BL40	24	3000K	Programmable	AS1	40	Black	8424450304716
★ 63353100302302	REQ44830-AS1BL70	48	3000K	Programmable	AS1	70	Black	8424450304723

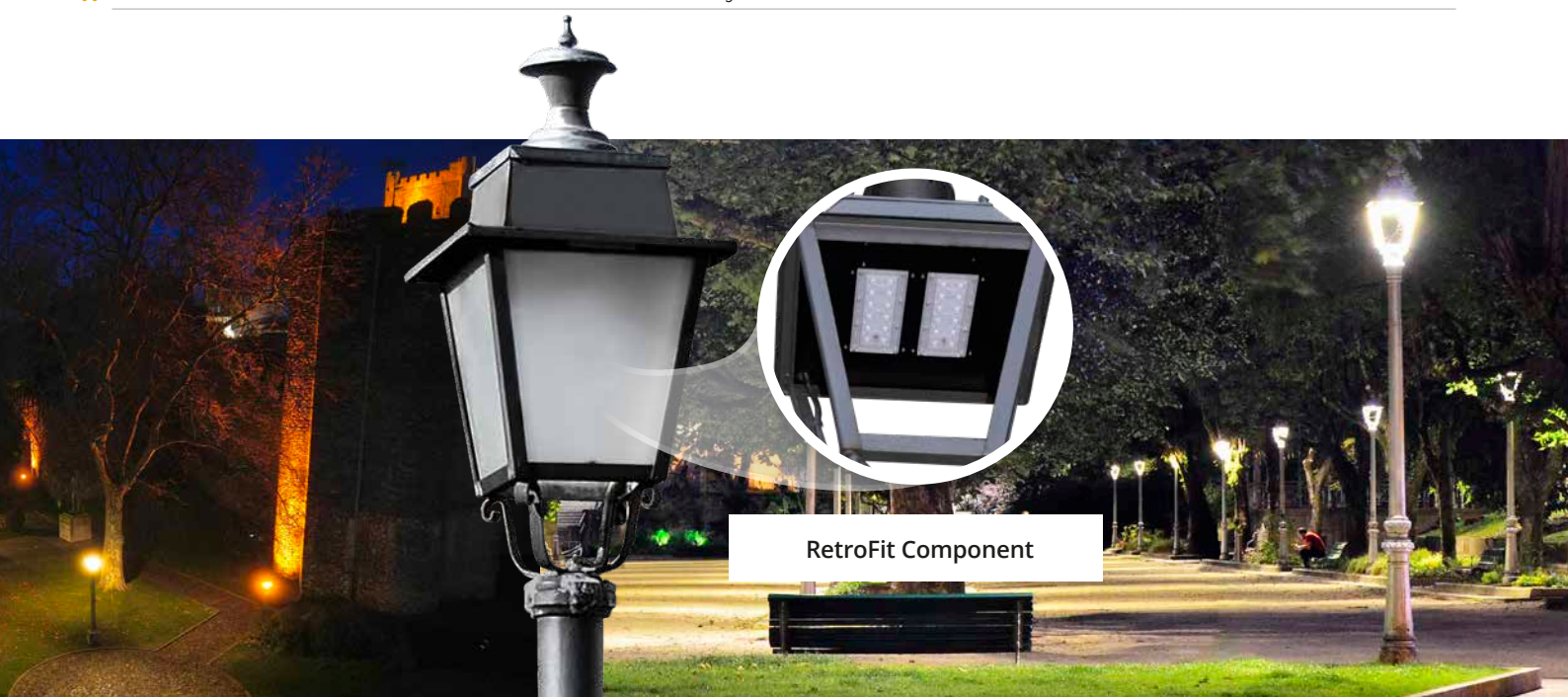

Multiple configurable options are available:

- Colour temperatures: PC Amber, 2,200K, 2,700K, 3,000K, 4,000K, 5,000K, 5,700K
 - Types of optics (light distribution in Appendix):
 - RETROFIT Component: P, SP, T2, ME, T3, T4, APZ, SCL, S30, S60, S90
 - RETROFIT Q Component: AS1, AS2, AS3, AS4
 - CRI: greater than 70, 80, 90
 - Finishes: any colour from the RAL range
- Price may vary depending on the option

LIGHTING RENOVATION (RETROFIT)

ACCESSORIES

REF.	LOGICAL REF.	DESCRIPTION	EAN13
6902010010	RFV1	Adaptable Frame for Villa Lamp, 280-320mm	8424450196311
6902010020	RFV2	Adaptable Frame for Villa Lamp, 300-340mm	8424450196328
6902010030	RFV3	Adaptable Frame for Villa Lamp, 340-380mm	8424450196335
6902010040	RFV4	Adaptable Frame for Villa Lamp, 380-420mm	8424450196342
6902010050	RFV5	Adaptable Frame for Villa Lamp, 420-460mm	8424450196359
6902020010	RFF1	Adaptable Frame for Fernandina Lamp, 290-326mm	8424450196380
6902020020	RFF2	Adaptable Frame for Fernandina Lamp, 326-353mm	8424450196397
6902020030	RFF3	Adaptable Frame for Fernandina Lamp, 353-395mm	8424450196403
6902020040	RFF4	Adaptable Frame for Fernandina Lamp, 371-412mm	8424450196410
6902020050	RFF5	Adaptable Frame for Fernandina Lamp, 412-454mm	8424450196427
★ 692101	SPIP66	Surge Protection device Class II. IP66	8424450271711



▲ Adaptable frame for Villa lamp

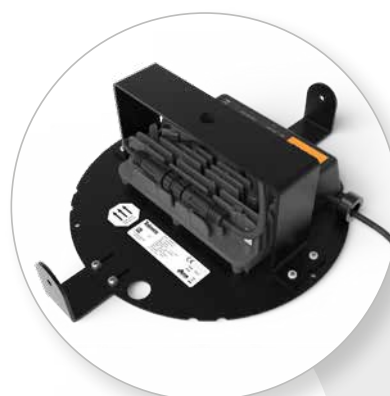

▲ Adaptable frame for Fernandina lamp

REMOTE MANAGEMENT

- ELECTRICAL SWITCHBOARD CONTROL
- POINT TO POINT CONTROL
- AURANT LIGHTING PLATFORM

AURANT
LIGHTING MODULE



REMOTE MANAGEMENT

ELECTRICAL SWITCHBOARD CONTROL

REF.	LOGICAL REF.	DESCRIPTION	EAN13
692001	RMC	Concentrator for electrical panel. 1 year connectivity	8424450231166
692010	ACT	Multifunctional Actuator for electrical switchboard, DIN rail installation	8424450231173

POINT TO POINT CONTROL

REF.	LOGICAL REF.	DESCRIPTION	EAN13
Nema Nodes			
695011	IOTNSIM	NB-IoT Remote Control Node, NEMA type for N series luminaires. 1 year connectivity	8424450223222
695021	IOTNSIM1NCE	NB-IoT Remote Control Node, NEMA type for N series luminaires. 10 years connectivity	8424450276945
Box Nodes			
★ 695110	IOTBXSIMN	NB-IoT Remote Control Node, BOX type for Flex Floodlights. 1 year connectivity	8424450280836
695111	IOTBXSIM	NB-IoT Remote Control Node, BOX type for standalone installation. 1 year connectivity	8424450223246
★ 695120	IOTBXSIM1NCEN	NB-IoT Remote Control Node, BOX type for Flex Floodlights. 10 years connectivity	8424450280843
695121	IOTBXSIM1NCE	NB-IoT Remote Control Node, BOX type for standalone installation. 10 years connectivity	8424450276921
Zhaga Nodes			
★ 695211	IOTZSIM	NB-IoT Remote Control Node, Zhaga type for Z series luminaires. 1 year connectivity	8424450285930
★ 695221	IOTZSIM1NCE	NB-IoT Remote Control Node, Zhaga type for Z series luminaires. 10 years connectivity	8424450285923

AURANT LIGHTING PLATFORM

REF.	LOGICAL REF.	DESCRIPTION	EAN13
694801	LIGSAASLUM	Full Service Remote Management for LED Lightning Module. Annual fee for luminaire	8424450246603
694802	LIGSAASPANEL	Full Service Remote Management for LED Lightning Module. Annual fee for concentrator panel	8424450246610

See remote management modalities in the Appendix.



▲ 692001



▲ 695011



▲ 695121



APPENDIX

1. CUSTOM LIGHTING PROJECTS
2. OUR PRODUCT SERIES
3. TYPES OF OPTICS
4. COLOUR TEMPERATURE RANGES
5. LIGHTING CONTROL OPTIONS
6. CERTIFICATIONS
7. SYMBOLOGY AND ABBREVIATIONS
8. REFERENCE CODING
9. GENERAL CONDITIONS OF SALE



1. CUSTOM LIGHTING PROJECTS

At Televes, we are committed to providing high-quality LED lighting solutions tailored to the unique needs of our customers. As manufacturers, we have the flexibility to design luminaires with multiple configurations, adapted to the requirements of each situation. Additionally, our technical team specialised in LED lighting studies every project in detail, to ensure the best results in terms of light distribution and luminaire type.

PROJECT STUDY AND DESIGN

We have consultants and a pre-sales team to analyze each project in a personalised and non-committal manner. We also offer downloadable plugins of our luminaires for programs such as Dialux, allowing our technical partners to carry out precise simulations.



CUSTOM LUMINAIRE MANUFACTURING

As manufacturers, we can design luminaires with various configurable options, including different numbers of LEDs, power levels, optics, finishes, lighting control, electrical class, and other technical parameters, such as CRI. Our automated production lines conduct meticulous and thorough quality control at every stage of production, ensuring the high quality of our products.



THANKS TO THE COMBINATION OF OUR HUMAN TEAM AND CUTTING-EDGE TECHNOLOGY, WE DESIGN SPECIFIC SOLUTIONS AND MANUFACTURE CUSTOMISED LUMINAIRES TAILORED TO EACH CUSTOMER'S NEEDS.

2. OUR PRODUCT SERIES

For each product range we have several variants that we call “series”, distinguished mainly by their lighting control mode. In this way, we offer several different options for managing the switching on and off of the luminaires, as well as adapting their intensity. This allows customers to select the option that optimises energy efficiency and enhances user service perception:

E SERIES

- Allows to regulate the luminous flux between 1 and 100% by varying the input signal voltage from 1 to 10V
- 1-10V communication protocol

E4 SERIES

- Built-in D4i certified drivers that facilitate integration with sensors and allow information to be stored
- Includes CLO regulation and programming by NFC
- DALI2 communication protocol

T SERIES

- Allows the luminous flux to be regulated in several luminaires at the same time by acting on the electrical panel
- Includes CLO regulation and programming by NFC
- Ready2Mains and U6Me2 communication protocol

N SERIES

- Includes ANSI C136.41 NEMA standard connector for Plug&Play connection to NEMA remote management nodes and sensor integration
- 1-10V communication protocol

Z SERIES

- Built-in D4i certified drivers and Zhaga Book 18 standard connector for Plug&Play connection to remote management nodes and integration with sensors
- Includes CLO regulation and programming by NFC
- DALI2 communication protocol

R SERIES

- Allows to regulate the luminous flux between 1 and 100% by varying the voltage of the input signal from 1 to 10V
- Includes lighting remote management: built-in IoT node, NBloT connectivity service and access to the Aurant Remote Management platform
- 1-10V communication protocol

3. TYPES OF OPTICS



The optics of a luminaire determine how the emitted light is distributed. The resulting light distribution depends on the luminaire's lens type, as the lens redirects and focuses light based on its shape and composition. In each application, the appropriate optics will vary depending on the direction, uniformity, and distribution of light. For instance, on roadways, it's common to use asymmetrical optics to illuminate the road area, while in gardens, symmetrical optics are often used to provide uniform illumination in all directions.

Choosing the right optics improves lighting with fewer resources and greater efficiency. For this reason, we recommend always carrying out a customised study that simulates the installation and the behaviour of the optics, in order to achieve the optimal performance.

The Types of optics available for our luminaires (depending on the model) are as follows:

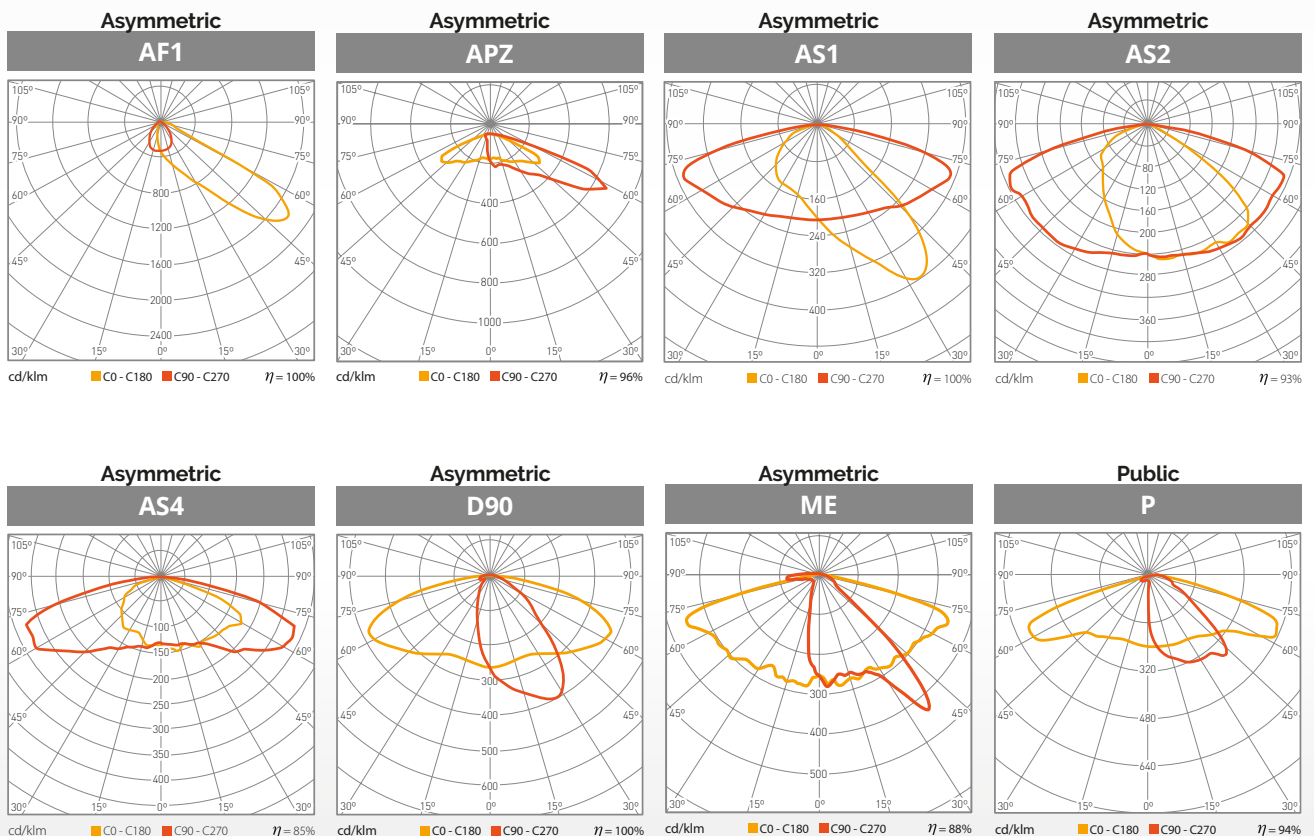

TYPES OF OPTICS

Public for crosswalks (Right)
PX

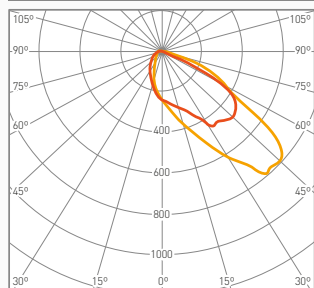

cd/klm ■ C0 - C180 ■ C90 - C270 $\eta = 100\%$

Public for crosswalks (Left)
PXL

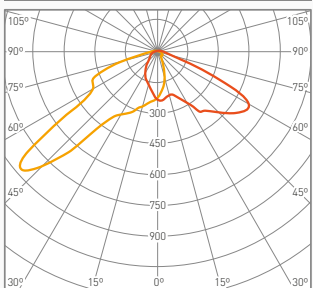

cd/klm ■ C0 - C180 ■ C90 - C270 $\eta = 96\%$

Symmetrical 20°
S20

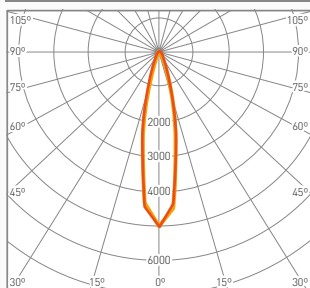

cd/klm ■ C0 - C180 ■ C90 - C270 $\eta = 96\%$

Symmetrical 30°
S30

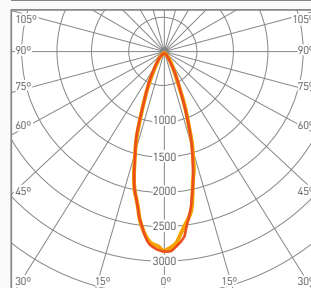

cd/klm ■ C0 - C180 ■ C90 - C270 $\eta = 100\%$

Symmetrical 40°
S40

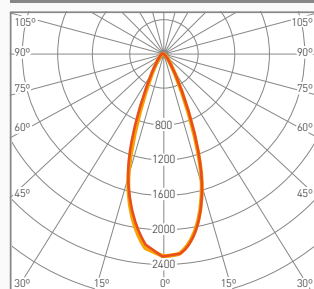

cd/klm ■ C0 - C180 ■ C90 - C270 $\eta = 96\%$

Symmetrical 60°
S60

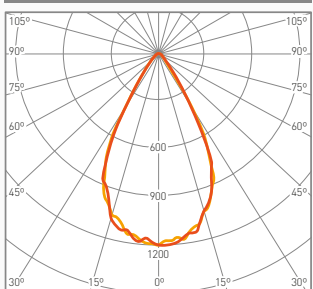

cd/klm ■ C0 - C180 ■ C90 - C270 $\eta = 99\%$

Symmetrical 90°
S90

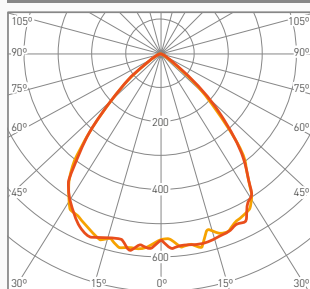

cd/klm ■ C0 - C180 ■ C90 - C270 $\eta = 100\%$

Symmetrical 120°
S120

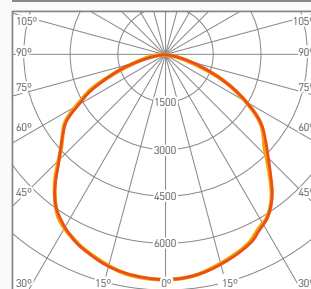

cd/klm ■ C0 - C180 ■ C90 - C270 $\eta = 100\%$

Asymmetric
SCL

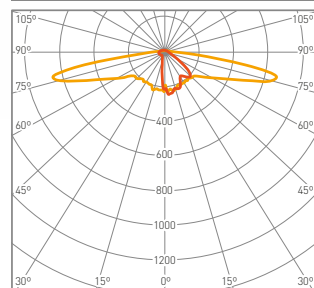

cd/klm ■ C0 - C180 ■ C90 - C270 $\eta = 86\%$

Public Symmetrical
SP

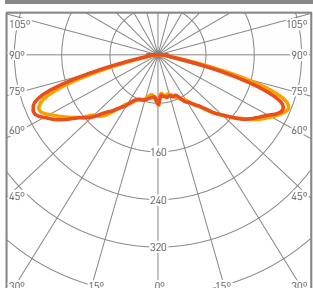

cd/klm ■ C0 - C180 ■ C90 - C270 $\eta = 96\%$

Asymmetric
T2

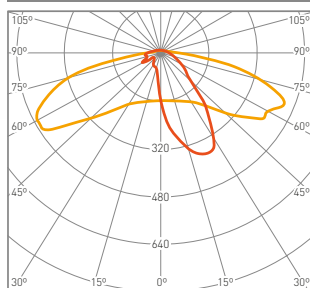

cd/klm ■ C0 - C180 ■ C90 - C270 $\eta = 90\%$

Asymmetric
T2C-90

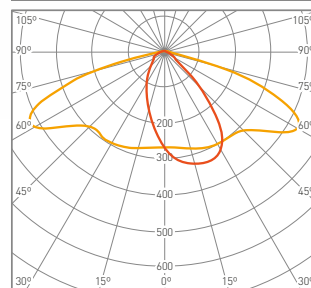

cd/klm ■ C0 - C180 ■ C90 - C270 $\eta = 89\%$

Asymmetric
T2M

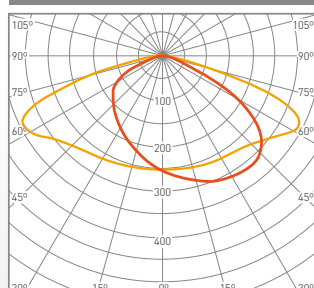

cd/klm ■ C0 - C180 ■ C90 - C270 $\eta = 100\%$

Asymmetric
T3

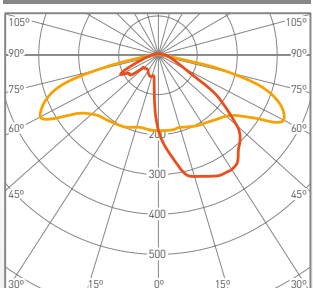

cd/klm ■ C0 - C180 ■ C90 - C270 $\eta = 92\%$

Asymmetric
T3B-90

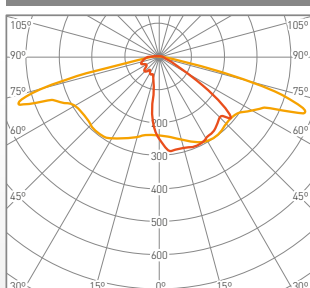

cd/klm ■ C0 - C180 ■ C90 - C270 $\eta = 95\%$

Asymmetric
T4

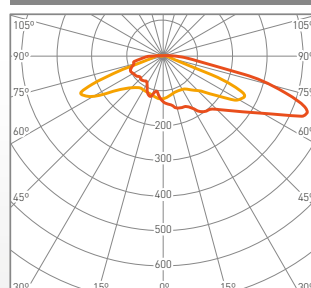

cd/klm ■ C0 - C180 ■ C90 - C270 $\eta = 94\%$

4. COLOUR TEMPERATURE RANGES



Colour temperature is a concept that aims to describe how we perceive the colour of light emitted by a light source, from a warmer (yellow and red tones) to a cooler appearance (blue tones). From a purely technical point of view, the colour temperature of a light source is defined by comparing its colour in the light spectrum to that of the light emitted by a black body heated to a certain temperature. For this reason, it is a relative parameter and is measured in degrees Kelvin, or simply Kelvin (K).

Colour temperature influences the sensations and biorhythms of living beings, which are naturally regulated by the daylight hours. Warm colour temperature invites relaxation and comfort, so that it is often used in recreational and rest areas, such as squares, gardens or promenades. On the other hand, the cool colour temperature activates performance and concentration, making it suitable for active environments such as workplaces, sports facilities or commercial areas. Finally, neutral or white light, at an intermediate point on the scale, offers a balance between warm and cool, being the most similar to natural midday light, and therefore the most versatile and suitable for a variety of environments.

It is important to note that the PC Amber colour temperature is the most respectful of the biological rhythms of living beings and light pollution. Hence, it is the recommended colour temperature in protected sky areas, such as natural parks or in proximity to astronomical observatories.

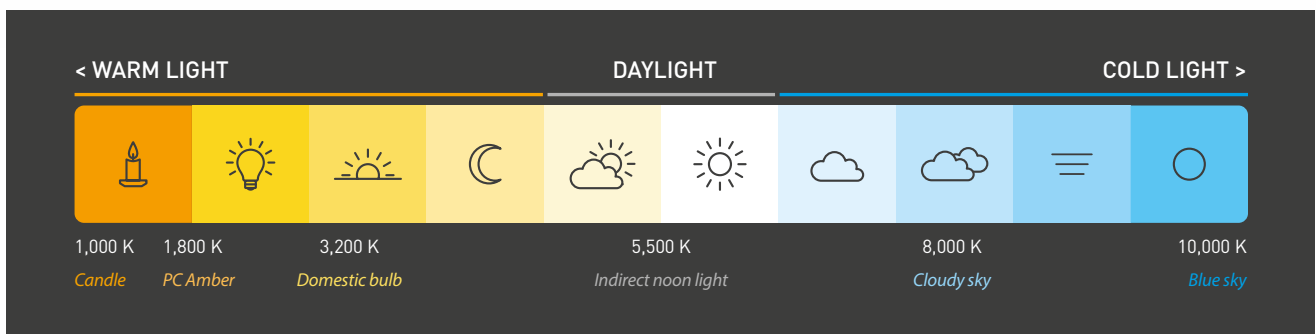

Choosing the right colour temperature is essential for making the most of spaces and energising urban life, protecting citizens and the quality of the night sky.

The most requested colour temperatures for our luminaires are as follows:

1,800K	PC Amber	4,000K	Neutral White
2,200K	Super Warm IAC White	5,000K	Cool White
2,700K	Warm IAC White	5,700K	Super Cool White
3,000K	Warm White		

5. LIGHTING CONTROL OPTIONS

Lighting control consists of regulating the light intensity based on the time and needs of each setting. **In this way, we are moving towards smart lighting systems that maximise energy and economic savings, reduce light pollution and, in general, provide a better service.**

The most common methods of lighting control and regulation are as follows:

A) NON-DIMMABLE (ON/OFF)

The luminaire has an **operating cycle with only two lighting levels:**

- On (ON - 100%), if mains power is supplied
- Off (OFF - 0%), if no power is supplied

It is not dimmable and when switched on, it will always operate at 100% power.

This lighting control option can be found in our **E-series**.

B) DIMMABLE (DIMMER OR PROGRAMMABLE)



During the luminaire's operating cycle, its lighting level is reduced or increased over time, depending on the control signal it receives. The aim of this regulation is to decrease the luminous intensity during off-peak hours and increase it during peak hours, thus achieving significant energy savings without impairing the service. Typically, the most appropriate dimming curve for each environment is preloaded into the luminaire.

The luminaires in our portfolio that include "**dimming control**" include a preloaded dimming program by default. This lighting control option can be found in our **E Series**.

Schedules and intensities of the lighting cycle can be customised for each client. Likewise, from Televes, we offer a standard preloaded program by default, with the following cycle:

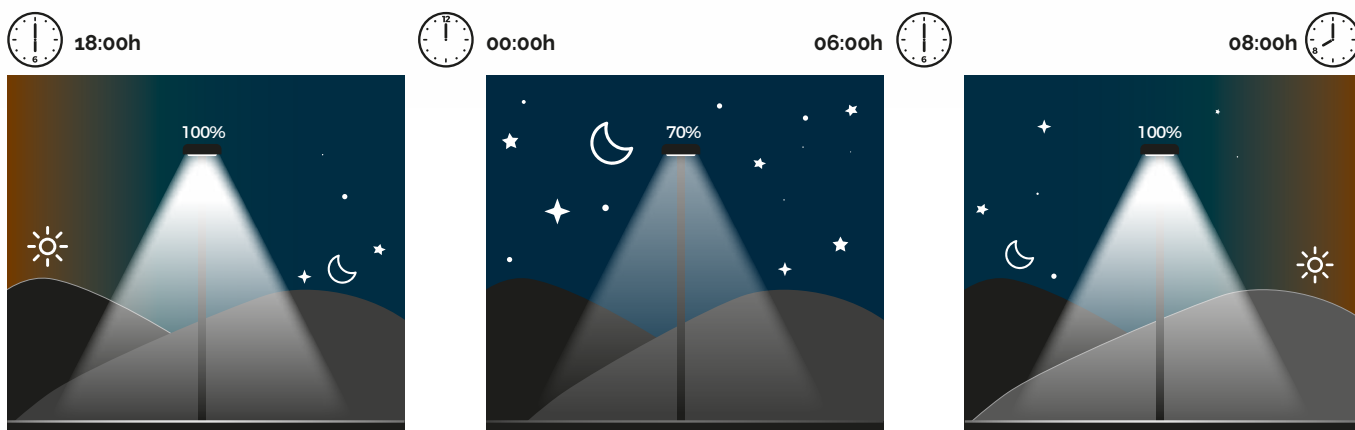

The luminaires in our portfolio that include "programmable control" allow customised dimming curves to be programmed and can be reprogrammed at any time.

This lighting control option can be found in our **E4 Series** (programming via NFC technology) and our **T Series** (programming via NFC technology and mains).

LIGHTING CONTROL OPTIONS

C) REMOTE MANAGEMENT OR REMOTE CONTROL

A remote management solution provides the ability to control different parameters of the luminaires remotely. The main function is to regulate the lighting level according to a specific schedule, with the advantage of being able to modify it centrally at any time. **The most complete and user-friendly solutions offer professionals a web interface for monitoring and managing remotely all their networks, such as our lighting module in Aurant platform.** In this module, it is possible to monitor the lighting network on the geographical map, visualise all the information of its status in dashboards, anticipate possible problems, configure alarms, calendars, and generate performance and improvement reports.

The series designed for Plug&Play connection of NB-IoT nodes, and therefore recommended for remote management solutions, are the **Z, N and R Series**.

There are two remote management modes, both compatible and combinable with each other:

ELECTRICAL SWITCHBOARD REMOTE MANAGEMENT: manages entire lines of luminaires through the electrical switchboard, using an actuator and a controller with connectivity. The communication of the controller with the Aurant platform allows dimming and monitoring of complete luminaire lines in a simple way.

It is an ideal solution for reducing network consumption with a reduced initial deployment.

POINT-TO-POINT REMOTE MANAGEMENT: each light point is operated independently by equipping each luminaire with an NB-IoT node with connectivity. The communication of the nodes with the Aurant remote management platform is bidirectional and allows comprehensive control of each luminaire, not only dimming or switching on and off, but also its geographical location and the collection of all relevant data.

It is a scalable solution, independent of the mains installation, where every light point matters, and therefore perfect for getting the most out of the lighting network.

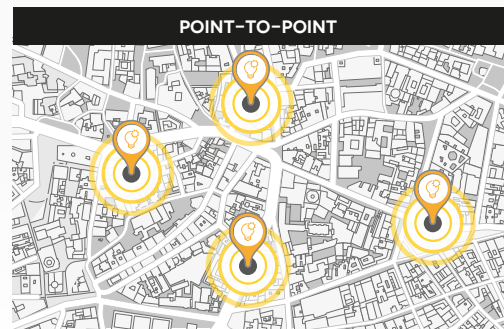
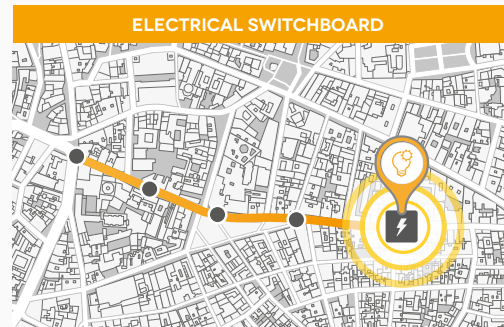

	ELECTRICAL SWITCHBOARD	POINT-TO-POINT
Luminaire information	x	✓
ON/OFF control of each light point	x	✓
Group management	✓	✓
Operation by lines	✓	✓
ON/OFF control by lines	✓	✓
Level regulation by luminaire	x	✓
Calendar	✓	✓
Status dashboard	✓	✓
Consumption information	✓	✓
User authentication	✓	✓
Ongoing monitoring	✓	✓
Incident management	✓	✓
Alarm history	✓	✓
Scalability	✓	✓
Integration in other platforms	✓	✓
Compatible with any brand	✓	✓
GPS	x	✓
OTA (Over The Air) updates	✓	✓
Integration with sensors	✓	✓

LIGHTING CONTROL OPTIONS

The elements necessary to achieve a remote management system are as follows:

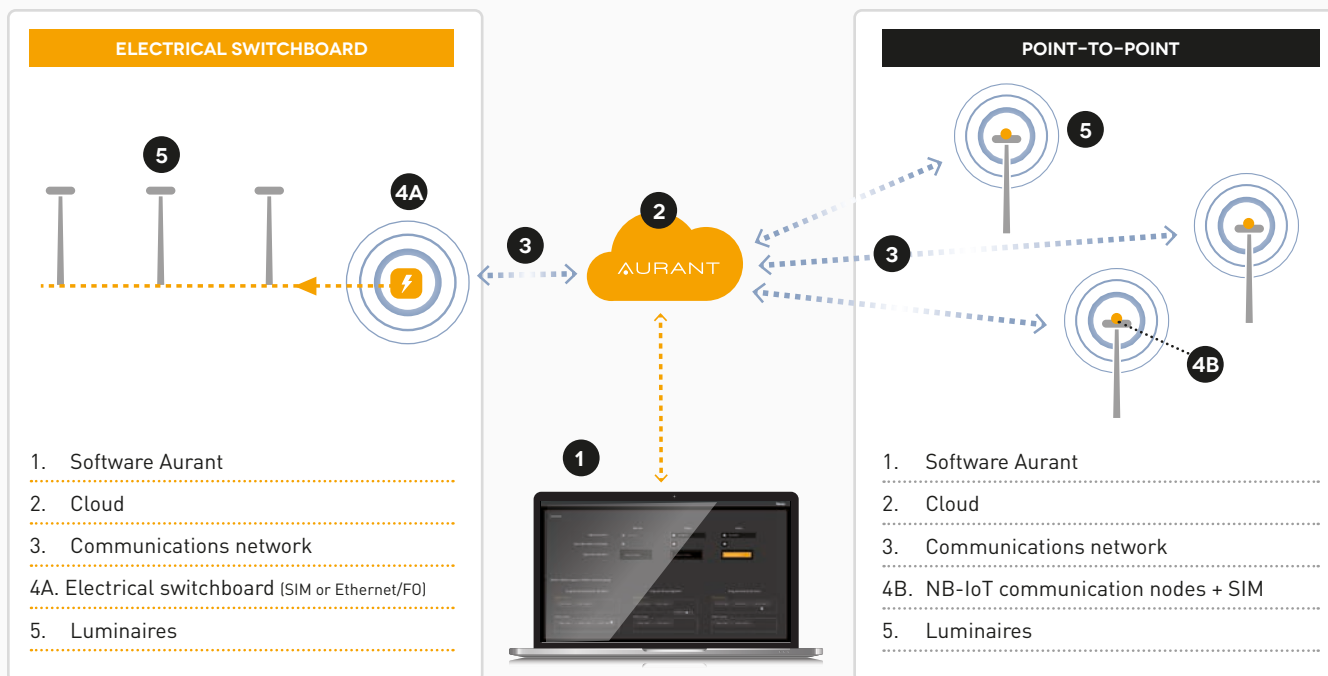

In both modes, to control the lighting it is necessary to use the Aurant remote management platform. **This is how our Full Service Remote Management models were born, in which we take care of everything: the infrastructure (cloud solution, data storage, security...) and the service (advice, technical assistance and updates).** As a manufacturer, we offer this service directly on a pay-as-you-go basis, so that our customer can have the monitoring of the lighting services in each project. We provide all the necessary elements for monitoring at the level of the electrical switchboard or each light point:

- SW licence for the management platform, including maintenance and new releases.
- Infrastructure necessary for the service (servers, storage, etc.) on our Cloud at Televés.
- The customer is responsible for the monitoring service.
- The connectivity service is included for the concentrator and actuator elements, or for the luminaire nodes, depending on the modality. The connectivity we offer from Televés is based on 2G/3G/4G, and is subject to operator coverage.

The contracting type depends on the remote management mode chosen by the customer:

REF.	LOGICAL REF.	DESCRIPTION	EAN13
694801	LIGSAASLUM	Full Service Remote Management for LED Lightning Module. Annual fee for luminaire	8424450246603
694802	LIGSAASPANEL	Full Service Remote Management for LED Lightning Module. Annual fee for concentrator panel	8424450246610

6. CERTIFICATIONS

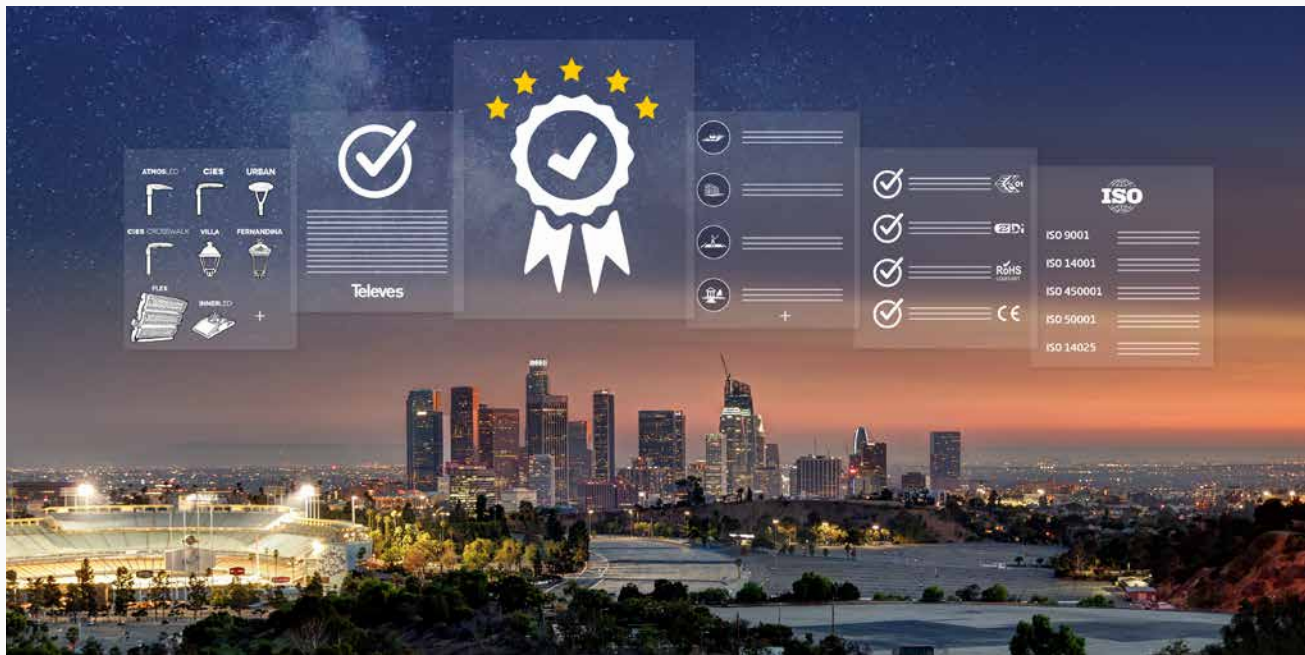

The current crowded marketplace can make it difficult to compare different brands and manufacturers. Certifications are a reliable way of accrediting the quality of a company's products and processes. **Certifications guarantee compliance with certain parameters, helping the customer to make a more convenient choice, with objective and solid criteria.**

Our long experience in design and in-house manufacturing, in addition to the quality guarantee in each part of the process, allows us to achieve the best results in our products. In this way, we have achieved different certifications for our luminaires.

ENEC Certification	RoHS Certification	ISO 45001: Occupational Health and Safety
Zhaga-D4i Certification	ISO 9001: Quality Management	ISO 50001: Energy Management
CE Marking	ISO 14001: Environmental Management	ISO 14025: Environmental Labels and Declarations

Furthermore, our commitment to the environment and the control of light pollution is a key factor, so we work towards responsible lighting. Thus, **our luminaires have been certified by the Astrophysics Institute of the Canary Islands (IAC) for sustainable luminaires that respect the night sky.**

IAC Certification in Ultra Warm White

IAC Certification in PC Amber



All our normative documentation is available at the following link:

doc.televes.com

7. SYMBOLOGY AND ABBREVIATIONS

GENERALES

-  Novelty
-  Product finish
-  Colour temperature
-  Remote management

SCOPE OF APPLICATION



Road and interurban

Roads with vehicular traffic, highways, high-speed roads, freeways, traffic circles, roundabouts, toll booths.

They are specific for areas where only vehicles use them.



Maritime areas

Ports, docks, streets, promenades.

They are recommended for spaces frequented by pedestrians and vehicles in aggressive environments such as maritime areas.



Urban and residential

Urban areas, streets, promenades, parks, residential areas, housing estates.

They are ideal for areas frequented by pedestrians, but also by vehicles.



Road safety

Crosswalks in urban areas and interurban roads, pedestrian crossings near parks and schools, low use streets, cycle paths, car parks.

They are used to highlight the presence of pedestrians, increasing their visibility and thus improving road safety.



Tunnels

Tunnels, underground passages, galleries.

They have been designed to illuminate tunnels in accordance with the requirements of the different areas. They guarantee visibility, safety and visual comfort, as well as a long service life under intensive use.



Lighting renovation

All types of public lighting.

Used especially in areas where it is important to maintain the luminaires due to their historical value.



Ornamental and decorative

Monumental areas, historical areas, protected heritage, bridges, churches, walls.

Linked to ornamental and/or decorative lighting, they provide ambient lighting integrated with the decoration of the area and are also used to highlight objects through light and shadow.



Sports areas

Sports areas such as sports centres, football pitches, basketball courts, paddle and tennis courts, swimming pools.

Designed for areas where precise control and direction of light is crucial.



Paths

Walks, paths, parks, gardens, hotels, terraces.

Essential for orienting and guiding passers-by, perfect for areas that require ambient lighting to maintain visibility.



Industrial

Industrial sector, production plants, logistics warehouses.

Indispensable for indoor areas requiring strict conditions of safety, robustness and durability of the luminaires.



Special facilities

Marinas, loading docks, airports.

They stand out for their high reliability, essential in areas where it is critical to maintain adequate lighting, ensuring the visibility and safety of users.

8. REFERENCE CODING

Our ranges of luminaires encompass a wide range of powers and number of LEDs, in addition to being customisable in the types of lighting control, colour temperatures, optics and their light distribution, and finishes. **A product can be configured according to these parameters, and ordered by its numerical or logical reference**, as follows:

SELECTING THE LUMINAIRE BY THE NUMERICAL REFERENCE

This is a numerical code made up of 14 digits:

- The first 6 digits represent a code that depends on the Series of the luminaire, the number of LEDs and the power.
- The next 8 digits allow you to choose the configurable parameters of the luminaire: lighting control, colour temperature, type of optics and finish.

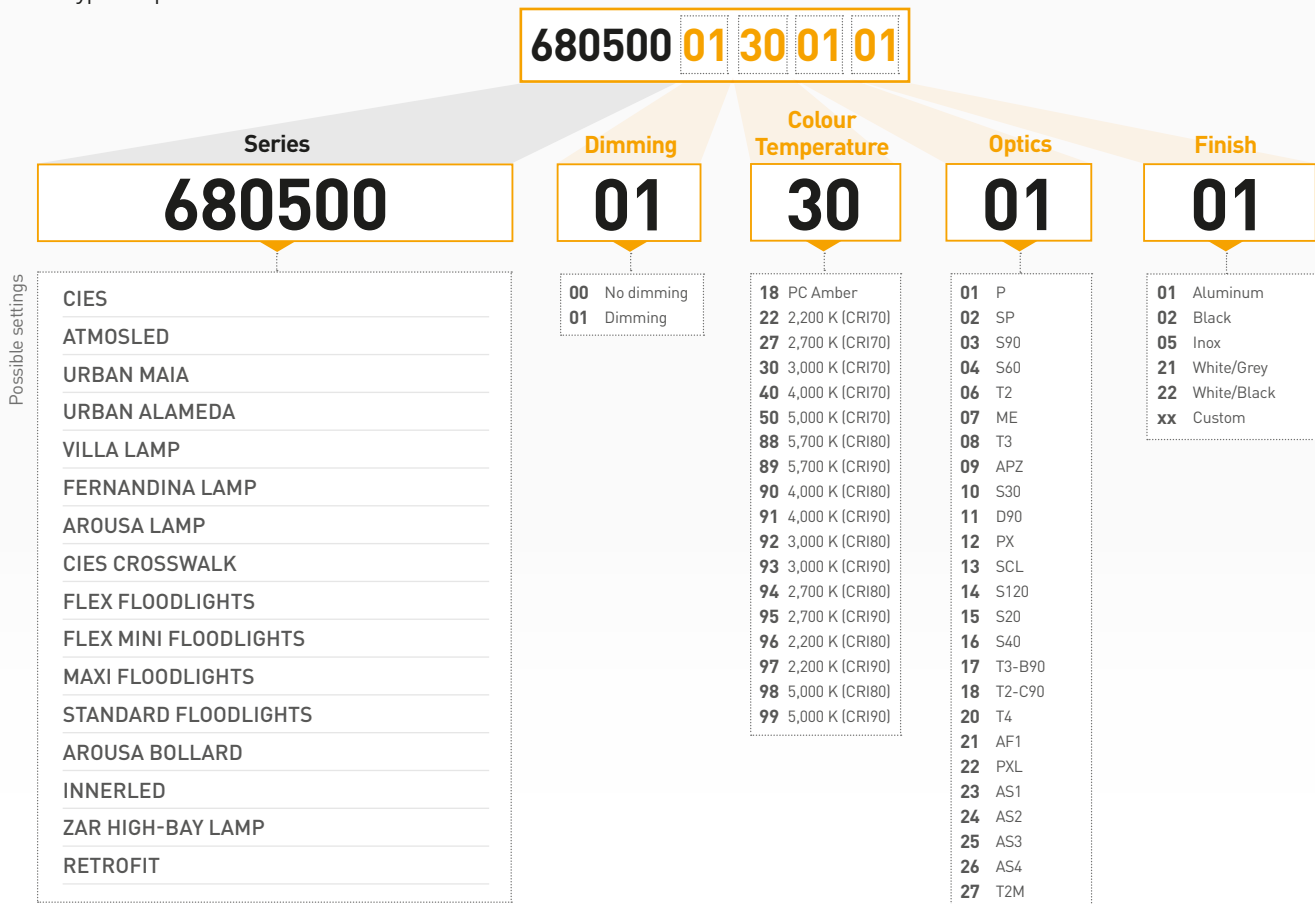

SELECTING THE LUMINAIRE BY LOGICAL REFERENCE

This is an alphanumeric code composed of an unlimited number of characters, describing the luminaire's characteristics using logical abbreviations, to facilitate its interpretation. It is divided into 2 groups of characters, separated by a hyphen:

- The first group specifies: the luminaire series, the number of leds, the colour temperature, and the lighting control.
- The second group specifies: the type of optics, the finish and the wattage.

An example of a logical reference: **UA2418D-D90BL53**

Range & LED number	Colour Temperature	Dimming	Optics	Finish	Power
UA24 Urban Alameda E 24LED	18 PC Amber	(ø) No dimming	SP	BL Black	53 53W
	22 2200K	D Dimming	D90	xx Custom	39 39W
	27 2700K		T2-C90		
	30 3000K		T3-B90		
	40 4000K				

UA	Urban Alameda
24	24 LEDs
18	Colour Temperature: PC Amber
D	Dimming included
D90	D90 Optics
BL	Black colour
53	53W Power

COMERCIAL NETWORK

FOR THE UNITED KINGDOM
& REPUBLIC OF IRELAND



Televes

TELEVES UNITED KINGDOM LTD

Unit 11 Hill Street, Industrial Estate
Cwmbran, Gwent Np44 7Pg
(UNITED KINGDOM)

📍 51° 38' 34.8144" N, 3° 1' 23.88" W

T. +44 (0) 1 633 87 58 21

F. +44 (0) 1 633 86 63 11

📧 televes.uk@televes.com

✉️ System Design: technical.uk@televes.com

TELEVES CONTACT DETAILS

ANDREW BRANN

Sales Director

M. +44 (0) 7778 846206

abrann@televes.com

TONY MACINNES

National Technical Sales
Executive

M. +44 (0) 7973 270263

tmacinn@televes.com

BARRIE O'NEILL

Hospitality Solutions Product
Manager

M. +44 (0) 0793 8500919

boneill@televes.com



lighting.televes.com

Televes[®]